

CURVED BLADE CEILING DIFFUSERS

INDIVIDUALLY ADJUSTABLE BLADES ON 1" CENTERS
1 WAY PARALLEL TO SHORT DIMENSION

MINIMUM SIZE: 6" WIDTH x 4" HEIGHT

MAXIMUM SIZE: 36" WIDTH x 36" HEIGHT

EXTRUDED ALUMINUM; 6063-T5

FINISH - SA (CLEAR ANODIZE) OR W (WHITE PAINTED)

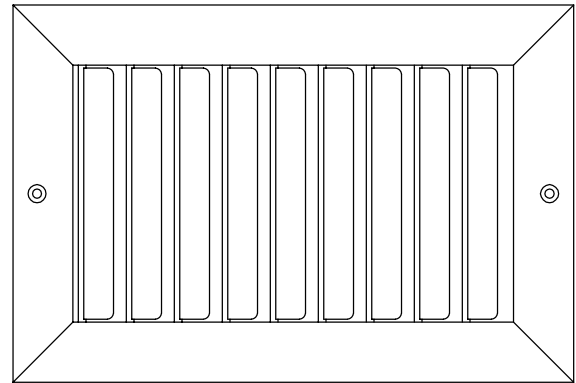

FACE VIEW

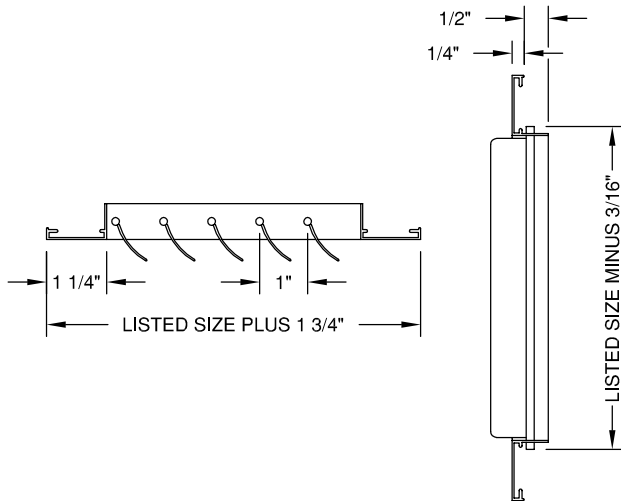

MODEL - C1S - 1 WAY SHORT - GRILLE

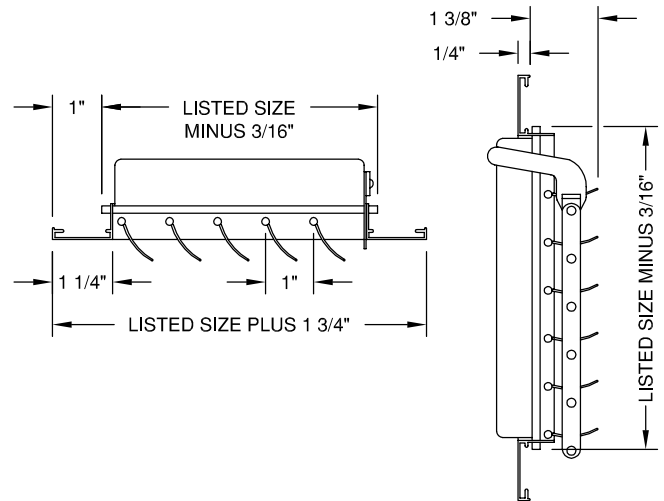

MODEL - C1SM - 1 WAY SHORT - MULTI-SHUTTER DAMPER

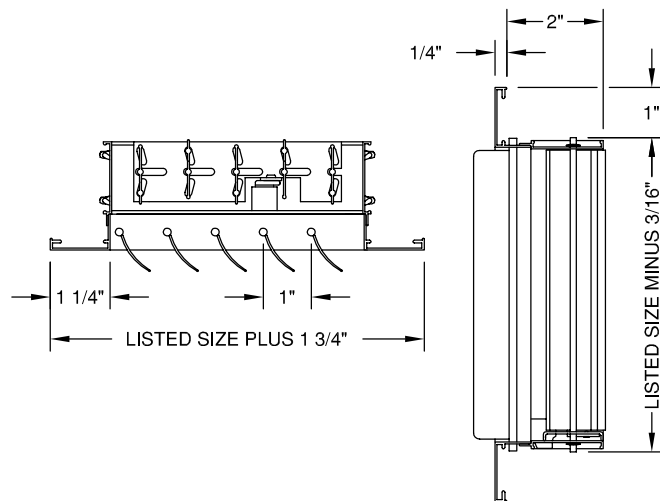

MODEL - C1SO - 1 WAY SHORT - OPPOSED BLADE DAMPER

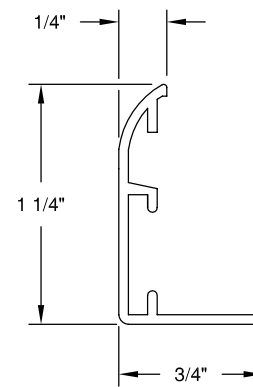

ALTERNATE "Z" FRAME

DWG NO.

02HV002A

JOB NAME: _____

ENGINEER: _____

DATE:

2/11/02

LOCATION: _____

CONTRACTOR: _____

ARCHITECT: _____

FINISH: _____