



A CSW Industrials Company

# HVAC-R Product Catalog



# TABLE OF CONTENTS

## Condensate Management

Aspen® Pumps	4	EZ Trap®	19	Drain Line Cleaners	35
Drain Hose & Fittings	14	AquaGuard®	22	Mighty Pump™	36
Safe-T-Switch®	16	Condensate Pans	30		

## Compressor Maintenance

AC Leak Freeze®	38	Kickstart®	44	Oil-ID™	45
Acid-Away®	42	Acid-Detector™	45	Turbo-Kleen™	46
Acid-Away® for POE	42	Acid-Detector™ for POE	45		

## Air Diffusers

Airtec® Classic & Retro	48	Airtec® Accessories	53	Airtec® Tuffbox	54
-------------------------	----	---------------------	----	-----------------	----

## Lineset Protection

Fortress®	56	SlimDuct®	56
-----------	----	-----------	----

## Locking Refrigerant Caps

Novent®	62
---------	----

## Mounting & Installation

Big Foot® Frameworks	66	Big Foot® Multi & Fix-It-Foot	72	Paircoil	76
Big Foot® Cube & Beam	69	Universal Brackets	74	Mighty Bracket™	77
Big Foot® Fast Fix Stands	70	NoKink™	76	Aspen® Xtra	78

## Pipe Joining

Thread Sealants	82	Solvent Cements	84	Soldering Flux	86
-----------------	----	-----------------	----	----------------	----

## Caulks & Sealants

Metacaulk® Firestopping	88	RectorSeal® RS 136	90	Silicone Sealants	90
-------------------------	----	--------------------	----	-------------------	----

## A/C Chemicals

Coil Cleaners	92	Cleaners & Treatments	95	Cooling Tower Treatments	95
Leak Locators	96				

## Heating Chemicals

Soot Removers	98	Deodorizers/Absorbents	99	Boiler Treatments	100
Cleaners & Degreasers	102				

## Specialty Products

Specialty Aerosols	104	Miscellaneous	105
--------------------	-----	---------------	-----

# Condensate Management

Aspen® Pumps

Drain Hoses

Safe-T-Switch®

EZ Trap®

AquaGuard®

Goliath®/Titan™ Pans & Risers

Drain Line Cleaners

Mighty Pump™

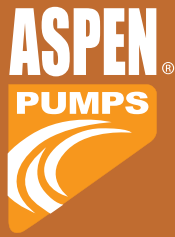

CONDENSATE PUMPS

# Condensate pumps designed

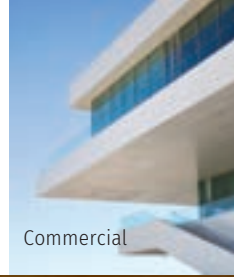

Commercial



- 7 Mini-split pump styles.
- Versatile pump positioning.
- Quiet operation.



ORANGE SERIES ▲



AQUA ▼

◀ MICRO V

LIME SERIES ▲

WHITE

MINI TANK  
4 installation options ▼

◀ PERISTALTIC  
remote placement -  
up to 10ft vertical or  
40ft horizontal from  
condensate source



ASPEN® is a registered trademark of Aspen Oldco Limited Company UK

The easiest way to find the right pump for any brand of mini-split ...



## for mini-split systems.



### SELECTING THE CORRECT ASPEN MINI-PUMP

#### Seven pump models

- Aqua • Orange • Lime • White
- Peristaltic • microV • Mini Tank

#### Four considerations

- **Appearance** - A concealed (Aqua, microV) or remote condensate pump (Orange, Peristaltic, mini tank) will preserve the attractive nature of any mini-split installation. Surface mounted pumps (Lime or White) are neatly covered. All pumps are hidden from view and provide a clean finished appearance.
- **Quiet Operation** - Choose a remote pump (Orange or Peristaltic) installation for the quietest operation in noise sensitive areas. Silent + models are also available. They run quieter and are designated by SP suffix.
- **Ease of Installation** - Aspen® pump models can accommodate any installation. See the guide and chart (page 13) for options.
- **Maintenance** - Pump models with filters must be cleaned regularly. Choose a surface type pump (Lime or White) for easy filter access or a pump which requires no filter (Peristaltic).

#### Two mini-pump types:

- **Split** - (Orange, Aqua or microV series) are designed with separate pump and reservoir. The pump includes an electronic PCB and the pump motor.

**The reservoir** contains the filter and the switching mechanism to activate the pump, and must always be kept level and clean for proper operation of the float switch. The filter must be cleaned regularly. The 2 elements are connected together with a length of 1/4" ID vinyl tube and a communication cable, both of which are usually around 6 feet long. On our orange series pumps, this may be extended if required.

- **Monobloc** - (Lime, White series, mini tank) are designed with both the pump and reservoir as one integral unit, sharing a common body. No connecting tubes or wires are needed. All mini pumps are cooled and lubricated by the water flowing through them. They require a float switch to detect the presence of water in the drain pan and activate the pump only when water is present.

#### Aspen® pump features:

- Quick and easy to install
- Fit any mini-split, up to 157,000 BTU/hr
- Self priming
- Hall effect sensors operate on water rise
- Dry contact for overflow protection
- Cleanable filters
- Quiet - 21dB (A) to 47dB (A)
- Thermally protected
- Maximum water temperature 104 degree F
- Discharge hose 1/4" ID
- Kits include all components required
- Anti-siphoning device included
- 24 month limited warranty

**NOTE:** Sound level and pump performance varies with voltage and frequency.



## ASPEN® MINI-SPLIT PUMP KITS

Continued

### Aqua Series



Ultra-slim profile, fits inside evaporator or lineset cover

Code	Universal Voltage Kits	Power Supply	Power Consumption	Ctn. Wt.	Qty.
83809	(ASP-MA-UNI)	100-250 VAC	.2A 16W	2lbs	1
Silent Plus Kits					
83812	(ASP-MA-230-SP)	250 VAC	.1A 16W	2lbs	1

#### FEATURES

- Ultra-slim profil
- Self Priming
- Integral hanging loop and separate reservoir facilitates attachment in vertical applications
- 3A NC dry contacts rated @ 5A inductive at 230V AC
- Modular terminals for fast connection
- Fully potted electronics\*

#### SPECIFICATIONS

- Duty Cycle:**  
50% duty cycle  
5 mins on / 5 mins off
- Capacity:**  
Up to 49,500 BTU/hr. @ 230v  
Up to 54,600 BTU/hr. @ 115v  
3.2 GPH @ zero head,  
1.6 GPH @ 33ft head
- Maximum head:** 33ft
- Suction lift:** 5ft
- Sound level:**  
Univolt - 21dB(A)  
Silent Plus - 19dB(A)
- Pump Dimensions:**  
L-6 1/2" x H-1 1/8" x W-1 1/8"
- Class:** II Appliance

#### TYPICAL PUMP LOCATIONS

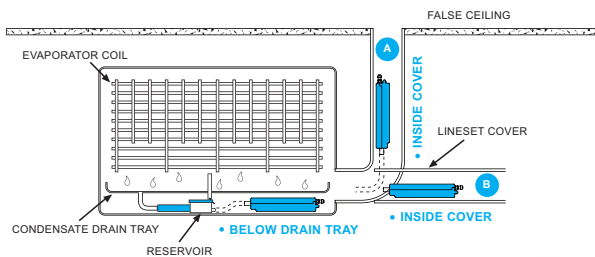

silent+

Aspen pre-filter available - see page 79

\*Potting is the process of epoxy filling a complete assembly for resistance to shock, vibration, moisture, chemical and promotes sound dampening. ASPEN® is a registered trademark of Aspen Oldco Limited Company UK

# Orange Series



## Installation flexibility, proven reliability

		Power Supply	Power Consumption	Ctn. Wt.	Qty.
<b>Code Universal Voltage Mini Kits</b>					
83909	(ASP-MO-UNI)	100-230 VAC	.17A 16W	2lbs	1
<b>Silent Plus Mini Kits</b>					
83911	(ASP-MO-115-SP)	115 VAC	.18A 16W	2lbs	1
83912	(ASP-MO-230-SP)	230 VAC	.11A 16W	2lbs	1
<b>Maxi Kits</b>					
83919	(ASP-MAXO-UNI)	100-240 VAC	.18A 21W	2lbs	1
<b>15' Extension Cable For Mini Kits</b>					
83891	(ASP-MOEXT)				

### FEATURES

- Self Priming
- Pump installs remotely above ceiling or inside lineset cover
- Pan mount and inline style reservoir included
- Modular terminals for fast connection
- Gravity Inlet
- Fully potted electronics\*
- 3A NC dry contacts rated @ 5A inductive at 230V AC

### SPECIFICATIONS

#### Duty Cycle:

Mini - non-continuous  
Maxi - 50% 5 mins on / 5 mins off

#### Capacity:

Mini - Up to 54,600 BTU/hr. @ 115v  
Up to 49,500 BTU/hr. @ 230v  
3.2 GPH @ zero head,  
1.6 GPH @ 33ft head  
Maxi - Up to 157,000 BTU/hr.  
8.9 GPH @ zero head,  
1.5 GPH @ 50ft head

#### Maximum head:

Mini - 33ft Maxi - 49ft

#### Suction lift: 5ft

#### Sound level:

Mini - 21dB(A) Maxi - 35dB(A)  
Silent Plus - 19dB(A)

#### Pump Dimensions:

Mini: L-4 $\frac{1}{4}$ " x W-1 $\frac{1}{2}$ " x H-2"  
Maxi: L-4 $\frac{7}{8}$ " x W-1 $\frac{3}{4}$ " x H-2 $\frac{5}{8}$ "

#### Class: II Appliance

### TYPICAL PUMP LOCATIONS

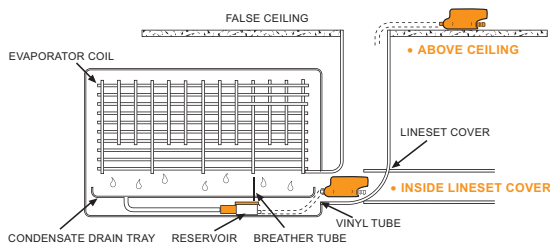

Aspen pre-filter available - see page 79

silent+

# ASPEN® MINI-SPLIT PUMP KITS

Continued

## Lime Series

Elbow design, completely reversible, duct included



### Pump Dimensions:

Mini: H-3 $\frac{1}{8}$ " x W-3 $\frac{3}{4}$ " x D-1 $\frac{5}{8}$ "

Maxi: H-3 $\frac{3}{8}$ " x W-3 $\frac{3}{4}$ " x D-1 $\frac{5}{8}$ "

### Lineset Casing Dimensions:

Mini/Maxi Elbow Casing:

H-5 $\frac{1}{4}$ " x W-5 $\frac{1}{4}$ " x D-2 $\frac{3}{4}$ "

Mini/Maxi Duct Casing:

H-31" x W-5 $\frac{1}{4}$ " x D-2 $\frac{3}{4}$ "

### TYPICAL PUMP LOCATIONS

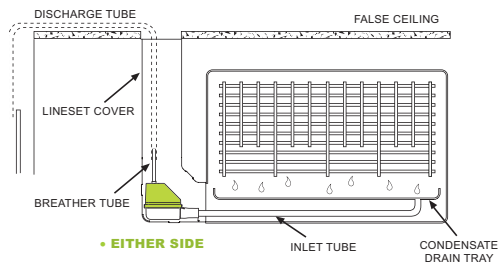

Code	Universal Voltage Mini Kits	Power Supply	Power Consumption	Ctn. Wt.	Qty.
83849	(ASP-ML-UNI) Slimline Ivory	100-230 VAC	.16A 16W	4 lbs	1
83859	(ASP-MLF-UNI) Fortress White	100-230 VAC	.16A 16W	4 lbs	1
Silent Plus Mini Kits					
83852	(ASP-ML-230-SP) Slimline Ivory	230 VAC	.10A 15W	4 lbs	1
Maxi Kits					
83831	(ASP-MAXLF-230) Fortress White	230 VAC	.10A 15W	4 lbs	1
OEM Maxi Kits					
83835	(ASP-MAXOEM-230) No Duct	230 VAC	.10A 15W	2 lbs	1
Code	OEM Mini Kits	Power Supply	Power Consumption	Ctn. Wt.	Qty.
83869	(ASP-MLOEM-UNI) No Duct	100-230 VAC	.16A 16W	2 lbs	1

### FEATURES

- Left or right install
- Easily accessed for filter cleaning
- Two lineset cover styles available - Slimline or Fortress
- 3A NC dry contacts rated @ 5A inductive at 230V AC
- Fully potted electronics\*

### SPECIFICATIONS

#### Duty Cycle:

Mini - non-continuous  
Maxi - 66% 10 mins on / 5 mins off

#### Capacity:

Mini - Up to 54,600 BTU/hr.  
2.9-3.2 GPH @ zero head,  
1.3-1.5 GPH @ 33ft head  
Maxi - Up to 157,000 BTU/hr.  
9.0 GPH @ zero head,  
2.9 GPH @ 49 head

#### Maximum head:

Mini - 33ft Maxi - 49ft

#### Sound level:

Mini - 25.5dB(A)  
Maxi - 35dB(A)  
Silent Plus - 21dB(A)

#### Class: II Appliance



Aspen pre-filter available - see page 79

\*Potting is the process of epoxy filling a complete assembly for resistance to shock, vibration, moisture, chemical and promotes sound dampening.

ASPEN® is a registered trademark of Aspen Oldco Limited Company UK



microV

Ultra-slim profile, fits inside evaporator or lineset cover



Code	Universal Voltage	Power Supply	Power Consumption	Ctn. Wt.	Qty.
83949	(ASP-MV-UNI)	100-250 V AC	.45A 16W	2lbs	1

**FEATURES**

- Compatible with all mini-split air conditioners brands/models
- Silent+, Univolt technology Plug and Play connection
- 3A NC dry contacts rated @ 5A inductive at 230V AC
- Fully Potted\*
- Self Priming

**SPECIFICATIONS**

- Duty Cycle:** continuous
- Capacity:** Up to 66,000 BTU/hr. 3.8 GPH @ zero head, 1.8 GPH @ 33ft head
- Maximum head:** 33ft
- Suction lift:** 6.6ft
- Sound level:** 19dB(A)
- Pump Dimensions:** H-1<sup>3</sup>/<sub>8</sub>" x W-4<sup>1</sup>/<sub>4</sub>" x D-1<sup>1</sup>/<sub>8</sub>"
- Class:** II Appliance

**TYPICAL PUMP LOCATIONS**

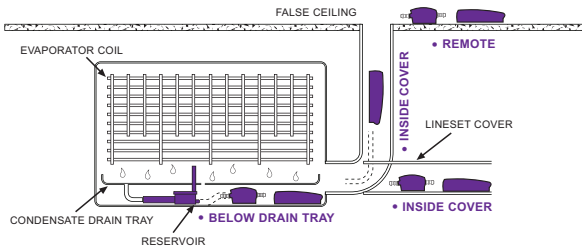

silent+

Aspen pre-filter available - see page 79



## ASPEN® MINI-SPLIT PUMP KITS

Continued

### White Series



Mounts directly below evaporator, quick installation

Code	Universal Voltage	Power Supply	Power Consumption	Ctn. Wt.	Qty.
83939	(ASP-MW-UNI)	100-250 VAC	.17A 16W	2lbs	1
Accessory					
83933	Ivory Cover			2lbs	1

#### FEATURES

- Surface mounts below evaporator, at either end
- Crisp white color and slim profile complement any evaporator. Additional colors available (contact RectorSeal®)
- Resilient mounting minimizes vibration & noise
- Cleanable replaceable plastic filter cartridge accepts water treatment tablet
- Accepts standard 5/8" drain hose from any mini-split
- Extra large reservoir capacity minimize pump operation
- All components clip apart for easy disassembly without tools
- Fully potted electronics\*
- No need to disturb evaporator to clean filter, reservoir clips out from front for easy removal and replacement
- 3A N/C dry contacts rated @ 5A inductive @ 230V AC

#### SPECIFICATIONS

- Duty Cycle:** Non-continuous
- Capacity:** Up to 54,000 BTU/hr.  
2.9 GPH @ zero head  
1.2 GPH @ 33ft head
- Maximum head:** 39ft
- Maximum Water Temp:** 104° F
- Suction Lift:** NA
- Sound level:** 21dB(A)
- Pump Dimensions:** L-7 1/8" x H-4 1/2" x W-2"
- Class:** II Appliance

#### TYPICAL PUMP LOCATIONS

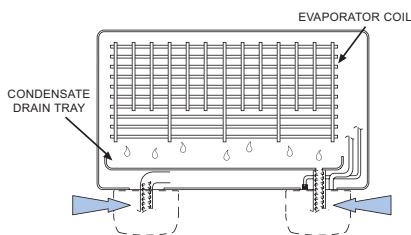

\*Potting is the process of epoxy filling a complete assembly for resistance to shock, vibration, moisture, chemical and promotes sound dampening. ASPEN® is a registered trademark of Aspen Oldco Limited Company UK

# Peristaltic



## Ideal for remote location applications

Code	Universal Sensor	Power Supply	Power Consumption	Ctn. Wt.	Qty.
83966	(ASP-PERI-UNI-230)	230 VAC	.20A 46W	6 lbs	1
Replacement Pump Head					
83892	(ASP-PERITUBE)				

### FEATURES

- Reliability - low maintenance
- Filterless operation. Pump evacuates wash from the evaporator coil during condensate production.
- Enables intermittent operation with a reservoir and float switch or continuous operation with the evaporator.
- Quick replacement pump head
- Self priming. Can run both wet and dry.
- 3 minute timer overrun protection
- Siphon proof
- Thermally protected pump
- Eliminates corrosion & clogging
- High level of lift allows remote placement - up to 10ft vertical or 40ft horizontal from condensate source
- Manual test switch
- Fire retardant housing
- Internal fuse
- Push in plug facilitates service without disconnecting wiring
- Wall bracket includes storage or spare pump head

### SPECIFICATIONS

- Duty Cycle:**  
100% Continuous
- Capacity:**  
Up to 30,000 BTU/hr.  
1.65 GPH @ 39ft head
- Maximum head:** 39ft
- Maximum Water Temp:** 104° F
- Suction Lift:** 10ft
- Sound level:** 47dB(A)
- Pump Dimensions:**  
L-5¼" x H-4½" x W-3"
- Class:** II Appliance

### TYPICAL PUMP LOCATIONS

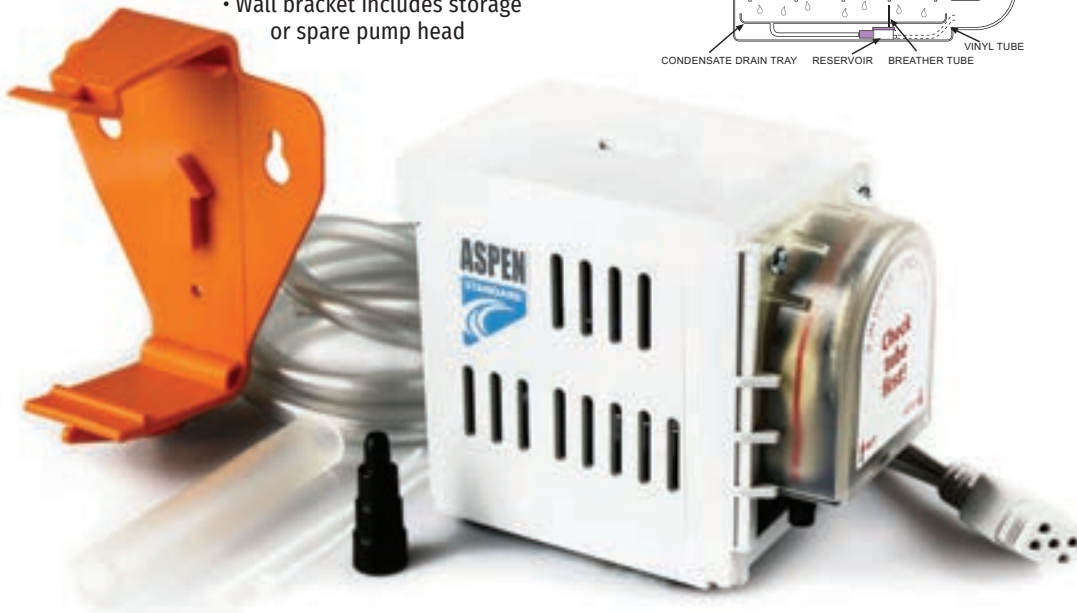
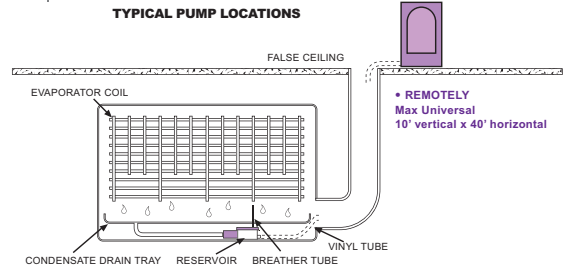

Aspen pre-filter available - see page 79

# ASPEN® MINI-SPLIT PUMP KITS

Continued

## Mini Tank

Versatile and powerful multi-functional condensate pump



Mounting Options:

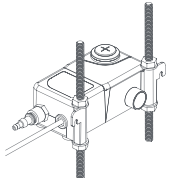
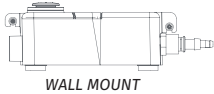
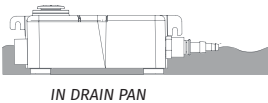
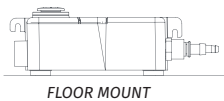

Code	Tank Pump Kit	Power Supply	Power Consumption	Ctn. Wt.	Qty.
83941	FP 1056/2	230 VAC	.15-.28A 21W	1.5 lbs	1

### FEATURES

- Ideal for ducted units, floor standing and chassis units, ceiling cassette units
- High performance piston technology
- Includes anti-siphon device.
- Great alternative to large and noisy traditional condensate pumps
- 4-installation options - can be wall mounted, floor mounted, in-pan or suspended on 1/4" / 3/8" rod.
- Accepts standard 5/8" drain hose from any mini-split
- Extra large reservoir capacity minimize pump operation
- Components clip apart for easy access to reservoir and filter
- Fully potted electronics\*
- No need to disturb evaporator to clean filter
- 3A N/C dry contacts rated @ 5A inductive @ 230V AC
- Thermal protection

### SPECIFICATIONS:

- Duty Cycle:**  
50% duty cycle  
5 mins on / 5 mins off
- Capacity:**  
Up to 157,000 BTU/hr.  
8.0 GPH @ zero head,  
1.6 GPH @ 49ft head
- Maximum head:** 49ft
- Maximum Water Temp:** 104° F
- Sound level:** 35dB(A)
- Pump Dimensions:**  
L-8½" x H-2⅝" x W-3½"



## Pump Selector Guide

	83809 (ASP-MA-UNI)	83812 (ASP-MA-230-SP)	83909 (ASP-MO-UNI)	83911 (ASP-MO-115-SP)	83912 (ASP-MO-230-SP)	83919 (ASP-MAXO-UNI)	83849 (ASP-ML-UNI)	83859 (ASP-MLF-UNI)	83852 (ASP-ML-230-SP)	83831 (ASP-MAXLF-230)	83835 (ASP-MAXOEM-230)	83869 (ASP-MLOEM-UNI)	83939 (ASP-MW-UNI)	83966 (ASP-PERI-UNI-230)	83949 (ASP-MV-UNI)	83941 MINI TANK PUMP
<b>Electrical</b>																
230V Model	•	•	•	•	•	•	•	•	•	•	•	•	•	•	•	•
115V Model				•												
Univolt Model	•		•	•	•	•	•	•	•	•	•	•	•	•	•	•
Overflow Switch	•	•	•	•	•	•	•	•	•	•	•	•	•	•	•	•
<b>Mounting</b>																
Surface Mount	•	•	•	•	•	•	•	•	•	•	•	•	•	•	•	•
Concealed in Evaporator	•	•	•	•	•	•	•	•	•	•	•	•	•	•	•	•
Concealed in Lineset Cover	•	•	•	•	•	•	•	•	•	•	•	•	•	•	•	•
Remote Pump Install (ideal for noise sensitive areas)	•	•	•	•	•	•	•	•	•	•	•	•	•	•	•	•
Easy Filter Access	•	•	•	•	•	•	•	•	•	•	•	•	•	•	•	•
Lineset Duct Kit included	•	•	•	•	•	•	•	•	•	•	•	•	•	•	•	•
<b>General</b>																
Inline Reservoir Included (5/8 inlet)	•	•	•	•	•	•	•	•	•	•	•	•	•	•	•	•
Drain Pan Mounted Reservoir Included (optional for ducted systems)	•	•	•	•	•	•	•	•	•	•	•	•	•	•	•	•
Integral Reservoir on Pump	•	•	•	•	•	•	•	•	•	•	•	•	•	•	•	•

For more detailed selection information see our Technical Bulletin "Selecting the Right Model Aspen® Pump for Your Mini-split Installation" on our web site.

Prior to installation, calculate condensate production of indoor evaporating coil to confirm suitability of condensate pump in application.

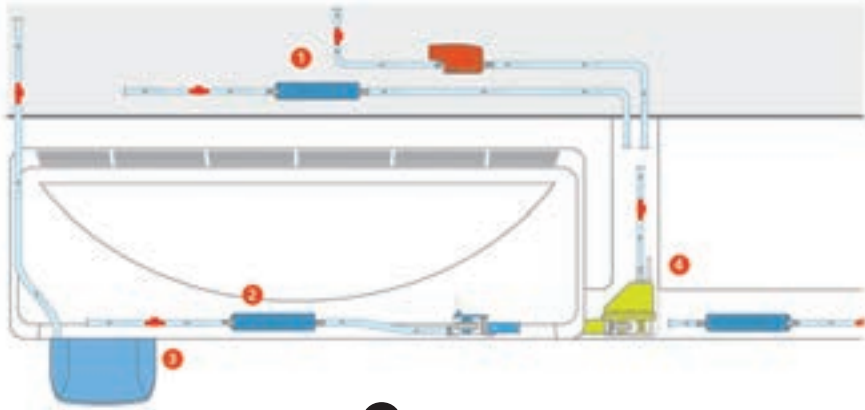

### Type 1 Installation

For optimum quietness, the solution is a remote mounted pump.

**PERISTALTIC, AQUA, ORANGE, microV, MINI TANK**

### Type 2 Installation - rear entry lineset

Lineset enters the evaporator from directly behind.

**WHITE** - Pump assembly mounts on wall surface below the evaporator (easy filter access).

**AQUA** - Both pump and reservoir mount inside of evaporator, below the drain pan.

**microV** - Both pump and reservoir mount inside of evaporator, below the drain pan.

### Type 4 Installation - exposed straight lineset

Lineset enters the evaporator from either side, extending horizontally to outside wall.

**AQUA, ORANGE or microV** - Pump mounts outside the evaporator hidden inside horizontal lineset cover. Reservoir mounts inside of evaporator, below the drain pan.

### Type 4 Installation - side entry lineset

Lineset enters the evaporator from either side, turns 90 degrees up into the ceiling and is completely concealed by lineset cover (included in kit).

**LIME** - Pump assembly mounts outside the evaporator, behind easy to remove elbow cover. Transparent reservoir clips off pump for easy filter access.



## MINI-SPLIT CONDENSATE DRAIN HOSE

### Condensate Drain Hose

Non-Insulated

Code	ID	Length	Ctn Qty	Ctn Wt
83001 (DH-14) STANDARD	1/2 in	164 ft	1	6 lbs.
83002 (DH-16) STANDARD	5/8 in	164 ft	1	7 lbs.
83003 (DH-16S) STANDARD	5/8 in	20 ft	5	6 lbs.
83004 (DHQ-16) UV RESISTANT	5/8 in	164 ft	1	6 lbs.
83005 (DSB-16) SMOOTH BORE	5/8 in	65 ft	1	2 lbs.



Non-Insulated

UV Resist

Smooth Bore



**Smooth Bore (DSB-16)**  
 Reduces resistance and maximizes condensate flow. Resists clogging.  
**UV Resistance (DHQ-16)**  
 Resists deterioration from Sunlight.

### Condensate Drain Hose

Insulated

Code	ID	Length	Ctn Qty	Ctn Wt
83011 (DSH-14)	1/2 in	65 ft	1	7 lbs.
83012 (DSH-20N)	3/4 in	65 ft	1	10 lbs.
83013 (DSH-25N)	1 in	65 ft	1	13 lbs.



Insulated



**Insulated**  
 Protects hose from sweating that can occur from cooler condensate and warmer ambient air.

## Fittings & Cable

For mini-split installation



### CONNECTOR FOR NON-INSULATED DRAIN HOSE

Code	ID	Ctn Qty	Ctn Wt
83028 (DHJ-14) Joins DH-14 hose to DH-14 hose	1/2 in	10	1 lb.
83029 (DHJ-16) Joins DH-16 hose to DH-16 hose	5/8 in	10	1 lb.



### PIPE ADAPTER

Code	ID	Ctn Qty	Ctn Wt
83031 (DSH-14C) INSULATED Joins DSH-14 insulated drain hose to A/C drain pipe	–	10	2 lbs.



### CONNECTOR FOR INSULATED DRAIN HOSE

Code	ID	Ctn Qty	Ctn Wt
83021 (DSH-14I) Joins DSH-14 hose to DSH-14 hose	1/2 in	10	2 lbs.
83023 (DSH-20-NI) Joins DSH-20 hose to DSH-20 hose	3/4 in	10	2 lbs.



### PIPE ADAPTER

Code	ID	Ctn Qty	Ctn Wt
83020 (DH-14-16V) Joins DSH-14 Hose to 3/4 PVC	3/4 in	10	2 lbs.
83024 (DSH-20-NV) Joins DSH-20 Hose to 3/4 PVC	3/4 in	10	2 lbs.



### VENTED DRAIN WYE\*

Code	ID	Ctn Qty	Ctn Wt
83022 (DY-16)	5/8 in	10	1 lbs.

\*Recommended to be used with EZT-180 Mini waterless in-line trap. EZT-180 can be found on page 21.



### WALL SLEEVE

Code	Size	Ctn Qty	Ctn Wt
83017 (NFP-75) WALL SLEEVE	3"x 5" - 7"	10	1 lb.



### NON-ADHESIVE WRAP

Code	Size	Ctn Qty	Ctn Wt
83016 (HN-75-I) UV RESISTANT NON-ADHESIVE WRAP	3" x 70'	4	1 lb.



### INTERCONNECT CABLE

Code	Length	Ctn Qty	Ctn Wt
87795 (CAB-14450) 4/C 14 GAUGE SHIELDED	50'	1	5 lbs.
87790 (CAB-144100) 4/C 14 GAUGE SHIELDED	100'	1	10 lbs.



## SAFE-T-SWITCH® OVERFLOW SWITCHES

The most reliable switch.

### Model SS1

Primary drains or auxiliary drain outlets

Code	Description	Qty.
97632	Model SS1	24
97631	Model SS1 (clear body)	24



#### FEATURES

- Condensate overflow switch
- Magnetic reed switch
- Install vertically or horizontally
- Connect to either red or yellow wire
- **NEW!** Includes directional cleanout tool to provide cleanout access.

#### APPLICATION

- Detects clogged A/C condensate drains and shuts off the system to prevent water damage to floors, walls and ceilings
- Can be installed horizontally or vertically, inline or on the primary pan's auxiliary drain outlet by using the included 3/4" adapter, bushing and cap
- Can be installed on a sloping line and does not need to be level or plumb.

US Patent No. 6,442,955



### Directional Cleanout Tool

Code	Description	Qty.
97629	Directional Cleanout Tool	24

#### FEATURES

- Simple, versatile, effective
- Works with Mighty Pump™ or standard shop vac

Cleanout access fitting

#### APPLICATION

- For directional cleanout of condensate drain line
- Fits perfectly with Safe-T-Switch SS1 and all 3/4" drain lines
- Can be left with the Safe-T-Switch or removed for future jobs.





## Model SS2

### Primary pan auxiliary outlet

Code	Description	Qty.
97637	Model SS2	24



#### FEATURES

- Condensate overflow switch
- Magnetic reed switch
- Connect to either red or yellow wire



#### APPLICATION

- Detects clogged A/C condensate drains and shuts off the system
- Using the 3/4" adapter the SS2 can be installed on the auxiliary outlet of the primary drain pan
- Easy access to the switch and the primary drain line for service

US Patent No. 6,442,955



## Model SS3

### Primary & auxiliary drain pans

Code	Description	Qty.
97647	Model SS3	24



#### FEATURES

- Condensate overflow switch
- Magnetic reed switch
- Connect to either red or yellow wire



#### APPLICATION

- Detects clogged A/C condensate drains and shuts off the system
- Steel mounting bracket clips firmly over the edge of most drain pans
- Slim profile can be installed on primary or auxiliary drain pans .

US Patent No. 6,698,215



## Model SS2AP

### Plenum rated

Code	Description	Qty.
97640	Model SS2AP	50



#### FEATURES

- Condensate overflow switch
- Magnetic reed switch
- Connect to either red or yellow wire



#### APPLICATION

- Detects clogged A/C condensate drains and shuts off the system
- Schedule 40 CPVC, plenum rated and listed to UL-2043
- Use 3/4" adapter to install on the auxiliary outlet of the primary drain pan.

US Patent No. 6,442,955



# SAFE-T-SWITCH® ELECTRONIC SWITCHES

## SS 103 E

### Dual sensors

Code	Description	Qty.
97692	SS 103 E	24



#### FEATURES

- Electronic probe sensor
- 5-wire design
- Onboard LED indicator
- 5 amp carrying capacity
- Either normally open or normally closed

**APPLICATION** • For primary drain line and auxiliary drain pan or auxiliary drain outlet and auxiliary drainpan • Can be installed horizontally or vertically or inline • Onboard LED indicates the condition of the unit at a glance

- No moving parts



## SS 500 EP

### Commercial rooftop downflow units

Code	Description	Qty.
97693	SS 500 EP	24



#### FEATURES

- Electronic probe sensor
- 5-wire design
- Onboard LED indicator
- Plenum rated wire
- 5 amp carrying capacity
- Either normally open or normally closed

#### APPLICATION

- Install on primary drain pan when plenum rating is needed
- Small size and slim profile great for use on commercial rooftop downflow units



## SS 610 E

### Mini-Split systems

Code	Description	Qty.
97622	SS 610 E	12



#### FEATURES

- Sensor connects to indoor units
- Onboard LED indicator can be mounted to side of unit
- Power supply - 15 to 250 volts AC, 15-100 volts DC
- Switching Capacity - 0 to 250 volts AC, 5A, 1259VA; 0 to 30 volts DC, 5A, 150W

#### APPLICATION

- Designed for mini-split systems • For installation directly on primary drain pan or clipped to coils above primary drain pan
- Multi-voltage
- No batteries required



US Patent No. 8,887,392

## SS 700 E

### Directly in the secondary drain pan

Code	Description	Qty.
97695	SS 700 E	24



#### FEATURES

- Multiple mounting angles
- Works in any position
- Universal puck works in all secondary drain pans
- Onboard LED indicator
- Stainless steel bracket
- Either normally open or normally closed

#### APPLICATION

- Designed to work in any position within a secondary drain pan, eliminating screws and clips • Multiple • Great for use in plastic overflow pans with round edges • Automatically resets when water drains or is removed from secondary pan





## EZ TRAP® 100 SERIES CLEAR TRAP™ KITS

Clear cleanable trap.

# EZ TRAP®

## Condensate Traps and Overflow Switches

Easy Maintenance & Overflow Protection

### SmartTrap™ (200 SERIES)

**1** adds a float switch that warns of blockage and shut down the A/C unit. Slip fit float switch removes easily for cleaning and inspection.

**2** Proven reliability and higher switching capacity with microswitch technology. (4A NO/NC)

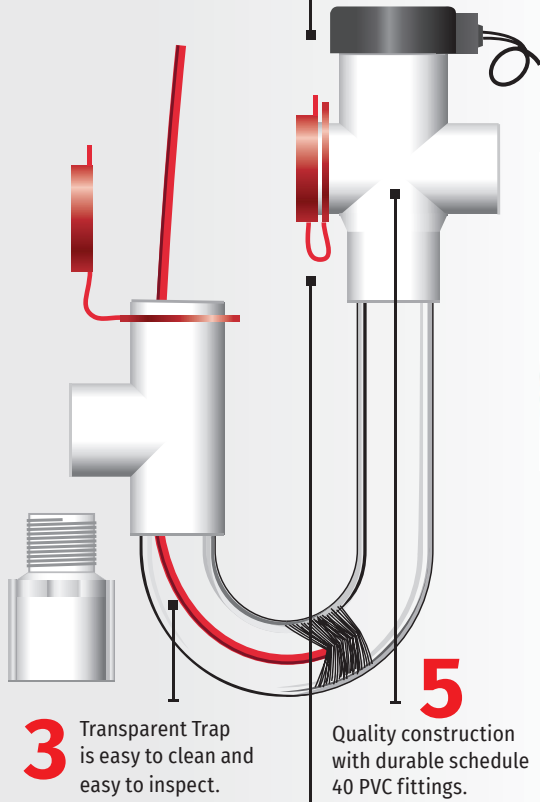

**3** Transparent Trap is easy to clean and easy to inspect.

**5** Quality construction with durable schedule 40 PVC fittings.

**4** Watertight red caps provide easy access to clean the trap and drain pan outlet.

**EZ TRAP®**

2 Year Warranty

Patent No. 5,069,042

RS # (ref. #) Size

83113 (EZT113) 3/4"



### Economy trap kit no/brush

Thinner walled trap for light duty applications. 10 per carton.

**Includes:** 3/4" trap, 3/4" cross, 3/4" tee, three 3/4" red caps, **1" drop.**

RS # (ref. #) Size

83114 (EZT113B) 3/4"



### Economy trap kit w/brush

Thinner walled trap for light duty applications. 10 per carton.

**Includes:** 3/4" trap, 3/4" cross, 3/4" tee, three 3/4" red caps, cleaning brush, **1" drop.**

RS # (ref. #) Size

83119 (EZT119) 1"



### High flow commercial trap kit

for use when a 1" dia. discharge is required. 10 per carton.

**Includes:** 1" standard trap, 1" cross, 1" tee, 1" x 3/4" reducer bushing, 3/4" black stub, two 1" red caps, 1" male adaptor, cleaning brush, **1" drop.**

RS # (ref. #)

83406 (EZT406)



### Standard Cleaning Brush

18" flexible rod. 25 per carton.

RS # (ref. #)

83405 (EZT405)

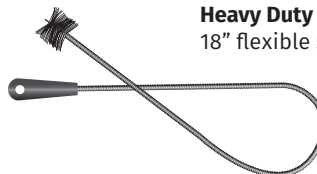

### Heavy Duty Cleaning Brush

18" flexible stainless rod. 10 per carton.

## 200 SERIES SMART TRAP™ KITS

Float switch overflow protection. Clear cleanable trap

RS #	(ref. #)	Size
83205	(EZT205)	3/4"



**Deep SmartTrap kit** for fluctuating static pressure found in systems with variable speed air handlers. 10 per carton. **Includes:** 3/4" Deep Standard Trap, 1" cross, 1" red cap, 1"x 3/4" bushing, 3/4" tee, 3/4" black stub, 3/4" male adapter, float switch assembly, 72" cable, cleaning brush, **3" drop**.

RS #	(ref. #)	Size
83207	(EZT207)	3/4"



**Side entry SmartTrap kit** for offset mounting on "A" coil applications on top of a vertical furnace. 10 per carton. **Includes:** 3/4" Standard Trap, 3/4" cross, two 3/4" red caps, 3/4" tee, 3/4" black stub, 3/4" male adapter, float switch assembly, 72" cable, cleaning brush, reducing tee, **1" drop**.

RS #	(ref. #)	Size
83210	(EZT210)	3/4"



**Standard SmartTrap kit** fits most applications requiring automatic shut down. 10 per carton. **Includes:** 3/4" Standard Trap, 3/4" cross, 3/4" red cap, 1"x 3/4" bushing, 3/4" tee, 3/4" black stub, 3/4" male adapter, float switch assembly, 72" cable, cleaning brush, **1" drop**.

RS #	(ref. #)	Size
83230	(EZT230)	3/4"



**Tamper resistant SmartTrap kit with threaded cleaning cap.** Fits most applications Includes clear u-bend for inspection, and access ports for easy cleaning. 10 per carton. **Includes:** 3/4" Standard Trap, 1" cross, 3/4" locking cap, 1"x 3/4" bushing, 3/4" tee, 3/4" black stub, 3/4" male adapter, float switch assembly, 72" cable, cleaning brush, **1" drop**.

## 220 SERIES OVERFLOW SWITCHES

Float switch overflow protection.

RS #	(ref. #)	Size
83224	(EZT224)	3/4"



**Compact overflow switch** with 3/4" male threaded inlet Thread into fitting on secondary drain pan. 10 per carton. **Includes:** 1"x 3/4" male threaded street ell, float switch assembly, 72" cable.

RS #	(ref. #)	Size
83225	(EZT225)	3/4"



**Inline universal primary/secondary overflow switch** 3/4" or 1" inlet, with 3/4" outlet. Install vertical or horizontal, inline or plugged. 10 per carton. **Includes:** 1"x 3/4"x 1" tee, 3/4" male adaptor, 3/4" plug, 1"x 3/4" bushing, float switch assembly, 72" cable.

RS #	(ref. #)	Size
83226	(EZT226)	3/4"



**Compact overflow switch with 3/4" female slip inlet** Two part design for use where obstructions prevent direct threading. 10 per carton. **Includes:** 1"x 3/4" slip female street ell, 3/4" male adaptor, float switch assembly, 72" cable.

RS #	(ref. #)	Size
83228	(EZT228)	3/4"



**Inline primary/secondary overflow switch** Same as 225 with clear extension tube for visual indication. 10 per carton. **Includes:** 1"x 3/4"x 1" tee, 3/4" male adaptor, 3/4" plug, 1"x 3/4" bushing, float switch assembly, extension tube, 72" cable.

# EZ TRAP® 100 SERIES WATERLESS KITS

Waterless freeze protection.



## UltraTrap™ Waterless Condensate Traps

For Negative & Positive Pressure Systems  
Up to .5" WG, Capacity 2.7 GPM

### UltraTrap™

**1** Unique patented design retains no water and needs no priming. Spring-assisted float eliminates standing water and freezing problems associated with conventional P traps. UltraTrap allows free flow of condensate while preventing reverse airflow.

**2** Captive twist-off locking ring.

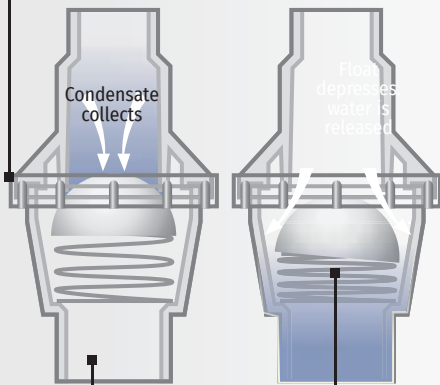

**3** Transparent trap allows for easy cleaning and inspection.

**4** Stainless steel spring.



2 Year Warranty

RS# (ref. #) Size

83150 (EZT150)

3/4" OR 1"



**UltraTrap waterless trap kit** eliminates standing water and freezing problems. Positive or negative pressure systems. 5 per carton.

**Includes:** 3/4" UltraTrap, 3/4" cross, two 3/4" red caps, 3/4" male adaptor, 3/4" coupler, cleaning brush.

RS# (ref. #) Size

83180 (EZT180)

5/8"



**Mini waterless in-line trap** sized for use in ductless mini-split\* applications. Use on any mini-split condensate drain line. Permits free condensate flow while blocking odors, noise and insects. Freeze resistant. Only 2-3/4" long. 10 per carton.

**Includes:** 5/8" MiniTrap, 9/16" adapter.

\*Per 2015 IMC 307.2.4.1 Commentary: All mini-splits shall require an inline check valve in the drain line or trap to prevent airflow from interfering with condensate flow and prevent the escape of air through the drain.

## 600 Combo kit

SERIES Clear Trap and Overflow Switch

RS# (ref. #) Size

83626 (EZT626)

3/4"

For coverage of the entire condensate drain system. 5 per carton.



**Compact overflow switch with 3/4" female slip inlet & economy trap kit w/brush**

Two part design for use where obstructions prevent direct threading.

**Includes:** 1" x 3/4" slip female street ell, 3/4" male adaptor, float switch assembly, 72" cable.

Thinner walled trap for light duty 3/4" blow molded trap, 3/4" cross, 3/4" tee, three 3/4" red caps, cleaning brush, 1" drop.



## AQUAGUARD® SENSORS

### AG-1100+

#### Magnetic Float Switch System for Metal Pans

Code	Description	Qty.
96100	Float Switch	30



#### FEATURES

- Easy, Drill-Free Installation
- Pull Up Test Knob
- Protective Cover
- UL 508

**APPLICATION** • The AG-1100+ is incredibly easy to install. It can be mounted to the drain pan in 10 seconds or less. Installation does not require any pre-drilling for screws. The AG-1100+ incorporates a protective cover to keep out insulation and debris that could prevent the float from rising.

- Normally Open 3rd Wire for Optional External Alarm, Digital Controller, or Energy Management System
- Residential and Commercial
- High Capacity 5 Amp, 24 Volt AC Magnetic Float Switch

US Patent 7,710,283



### AG-1200+

#### Magnetic Float Switch System for Metal & Plastic Pans

Code	Description	Qty.
96106	Float Switch	30



#### FEATURES

- Easy, Drill-Free Installation
- Pull Up Test Knob
- Protective Cover
- UL 508

**APPLICATION** • The AG-1200+ has all of the features of the 1100+ plus an innovative two-piece clamp design which allows it to be mounted to a metal secondary drain pan (without a lip) or a plastic secondary drain pan (with a lip) in 10 seconds or less, without screws or drilling. Protective cover keeps out insulation, pests and debris.

- Normally Open 3rd Wire for Optional External Alarm, Digital Controller, or Energy Management System
- Residential and Commercial
- High Capacity 5 Amp, 24Volt AC Magnetic Float Switch

US Patent 7,710,283



## AG-1250E

### Multipurpose Water Sensor

Code	Description	Qty.
96108	Water Sensor	30



#### FEATURES

- Either normally open or normally closed
- Solid state sensor with water detection LED
- NEW adjustable height mount
- 6 feet of control wire
- 5 amp capacity, 0-24 Vac/dc
- Can be used with communicating systems
- UL 508

**APPLICATION** • The AG-1250E multipurpose water sensor is mounted directly in a metal or plastic secondary pan, floor or wall. The AG-1250E is a high-amperage, solid state sensor with no moving parts to break down or become clogged. The low profile design makes it easy to install.

- Normally Open Wire for Optional External Alarm, Digital Controller or Energy Management
- Versatile mounting options allow positioning on the unit, in a secondary pan, floor or wall
- Clip on mounting base for easy cleaning and drying of sensor

US Patent 8,578,770



## AG-2550E

### Inline Water Sensor

Code	Description	Qty.
96110	Inline Water Sensor	10



#### FEATURES

- Removable cap
- Install horizontal or vertical
- Water detection LED light
- Bonus secondary sensor
- Either normally open or normally closed
- 6 feet of probe & sensor wire
- Elbow & straight coupling adapters included
- 5 amp capacity, 0-24 Vac/dc
- Can be used with communicating systems
- 2 Sensors for price of 1
- UL 508

**APPLICATION** • The AG-2550E electronic water sensor is designed for use on the primary drain line and is integrated with an access port for clearing and removing clog causing debris. The water sensor has no moving parts and the unique design of the insulated housing allows the application of chemicals to clean the drain without any worry of retrograde backflow into your HVAC unit.

- Electronic In-Line Water Sensor and Insulated Access Port for Primary Drain Lines
- Unobstructed 3/4 Inch Flow-Switch does not Impede Drainage
- Integrated Easy Access Port for Cleaning Out Drain Lines and Adding Chemicals.
- Bonus Secondary Sensor with Water Detection LED Light for secondary drain pans
- Normally Open Wire for Optional External Alarm, Digital Controller or Energy Management Systems.

US Patent 8,154,313 & 8,578,770



# AQUAGUARD® SENSORS

Continued

## AG-3125E

### Primary Pan Sensor

Code	Description	Qty.
96120	Primary Pan Sensor	30
96122	Primary Pan Sensors - 6pk	5



#### FEATURES

- Time delay
- Water detection LED
- Adhesive tape mounting
- 6 feet of wire
- Either normally open or normally closed
- 5 amp capacity, 0-24 Vac/dc
- Can be used with communicating systems
- UL 508

**APPLICATION** • The AG-3125E primary pan sensor is mounted directly in the auxiliary drain port of the primary pan. The AG-3125E is a high amperage (24VAC, 5Amp), solid state sensor with no moving parts to break down or become clogged. • Voltage rating: 24 vac, 5 amp • LED indicator light for easy troubleshooting • Compact waterproof design

US Patent 8,151,580; 8,154,313; 8,561,417; 8,578,770



## AG-3150E

### Primary Pan Sensor

Code	Description	Qty.
96124	Primary Pan Sensor	10



#### FEATURES

- Time delay
- Install horizontal or vertical
- Water detection LED light
- Bonus secondary sensor
- Compact waterproof design
- Either normally open or normally closed
- 5 amp capacity, 0-24 Vac/dc
- Can be used with communicating systems
- UL 508

**APPLICATION** • The AquaGuard AG-3150E primary pan sensor is mounted directly in the auxiliary drain port of the primary drain pan. The bonus secondary sensor can be installed either vertically or horizontally and features a water detection LED. • Redesigned Probe Sensor for Increased reliability • Two Sensors for the Price of One • 6 Feet of Both Probe & Sensor Wire • 5 Amp, 24 Volts AC Solid State Sensor with Water Detection LED Light • Normally Open Wire for Digital Controller or Energy Management Systems

US Patents 7,744,395; 8,151,580; 8,154,313; 8,561,417; 8,578,770





## AG-3175E

### Primary Pan Sensor (Plenum Rated)

Code	Description	Qty.
96126	Primary Pan Sensor	10



#### FEATURES

- Time delay
- Plenum-rated probe & wire
- Install horizontal or vertical
- Water detection LED light
- Bonus secondary sensor
- Compact waterproof design
- Either normally open or normally closed
- 5 amp capacity, 0-24 Vac/dc
- Can be used with communicating systems
- UL 508

**APPLICATION** • The AquaGuard AG-3175E's primary pan sensor is mounted directly in the auxiliary drain port of the primary drain pan. The bonus secondary sensor can be installed either vertically or horizontally and features a water detection LED.

- Redesigned probe sensor for increased reliability
- Two sensors for the price of one
- 6 Feet of both plenum rated probe & sensor wire
- 5 Amp, 24 Volts AC solid state sensor with water detection LED light
- Normally open wire for optional external alarm, digital controller or energy management systems

US Patents 7,744,395; 8,151,580; 8,154,313; 8,561,417; 8,578,770



## AG-2510

### AquaMate In-line Accessory Port

Code	Description	Qty.
96186	In-Line Port	10

#### FEATURES

- Allows easy access
- Install horizontal or vertical
- Prevents retrograde backflow
- Pre-insulated to prevent freezing or cracking

**APPLICATION** • The AG-2510 AquaMate In-Line maintenance and clean out port attaches directly to the primary or secondary drain line and allows easy access into the drain line for routine maintenance or in the event of a clog, which can be caused by dust, debris or insulation.



# AQUAGUARD® SENSORS

Continued

## AG-3180E

### Micro Pan Sensor (Plenum Rated)

Code	Description	Qty.
96128	Micro Pan Sensor	10



#### FEATURES

- Time Delay Up to 60 sec
- Plenum Rated Probe & Wire
- Micro pan sensor
- Water detection LED light
- Bonus Secondary Sensor
- Adjustable mounting clips
- Can be mounted with double sided tape or adjustable mounting clips
- UL 508

**APPLICATION** • The AquaGuard AG-3180E micro-electronic condensate sensor is mounted directly in the primary drain pan.

The bonus secondary sensor features water detection LED and easily installs in the metal or plastic secondary drain pan. Both sensors continuously monitor any condensate overflow in the primary and secondary drain pans and automatically shut off the system and activate an alarm if any overflow is detected.

- Ideal for commercial package units, metal/plastic secondary drain pans & primary pan with time delay
- Meets International Building Codes & Primary Pan Code Requirements
- 6 Feet of Both Plenum Rated Probe and Sensor Wire
- 5 Amp, 24 VAC Solid State Sensor
- Switch Can Be Normally Open or Normally Closed
- Normally Open Wire for Optional External Alarm, Digital Controller or Energy Management Systems



US Patent 8,578,770



## AG-4200E

### Electronic Condensate Management System

Code	Description	Qty.
96143	Primary Pan Sensor	1



#### FEATURES

- Either normally open or normally closed
- 5 amp, 24 volts AC solid state sensor with water detection LED light
- Adjustable height mount
- 6 feet of control wire
- UL 508

**APPLICATION** • Multipurpose Condensate Overflow Sensor that combines the proven water sensing technology of the AG-1250E with our industry leading Goliath and Titan drain pan line to deliver the ultimate condensate management system.

The AG-4200E is the complete condensate management system

for Goliath, Goliath Furnace, Goliath Value Series and Titan Drain Pans

- 24 VAC, 5 Amp • 6' of Standard Control Wire • Compact Waterproof Design
- Includes Vibration Isolators



US Patent 8,578,770; 8,317,169

## AG-4200M

### Magnetic Condensate Management System

Code	Description	Qty.
96142	Primary Pan Sensor	1



#### FEATURES

- Easy, Drill-Free Installation
- Pull Up Test Knob
- Water detection LED light
- Protective Cover
- UL 508

**APPLICATION** • Multipurpose condensate overflow sensor that combines the incredibly easy to install AG-1100+ with our industry leading Goliath and Titan drain pan line to deliver the ultimate condensate management

system. It can be mounted to the drain pan in 10 seconds or less. Installation does not require any pre-drilling for screws. The AG-1100+ incorporates a protective cover to keep out insulation and debris that could prevent the float from rising. The AG-4200M is the complete condensate management system for Goliath, Goliath Furnace, Goliath Value series and Titan Drain pans.

- 3/4" PVC threaded male pipe adapter • Normally Open 3rd Wire for Optional External Alarm, Digital Controller, or Energy Management System • Residential and Commercial • High Capacity 5 Amp, 24Volt AC Magnetic Float Switch
- Includes Vibration Isolators

US Patent 8,578,770; 8,317,169



# AQUAGUARD® SENSORS

Continued

## AG-4250E

### Primary and Secondary Pan Condensate Sensor

Code	Description	Qty.
96148	Condensate Management System	1



#### FEATURES

- Two sensors
- Time delay up to 60 sec
- Smart sensor technology
- 1/4 inch trigger depth
- Water detection LED light
- Wire for alarm
- Either normally open or normally closed
- UL 508

**APPLICATION** • We've combined the proven water sensing technology of the AG-3150E with our industry leading drain pans to deliver the ultimate condensate management system. Providing the security of TWO sensors and the durability of our drain pans. The AG-4250E is the complete condensate management system for Goliath, Goliath Furnace, Goliath Value, and Titan Flexible Series Secondary Drain Pans.

- 2 Sensors - Primary and Secondary Pans
- 24 VAC, 5 Amp
- Smart Sensor Technology (Patent Pending)
- 6' of Standard Control Wire
- Compact Waterproof Design
- Includes Vibration Isolators

US Patent 8,578,770; 8,317,169

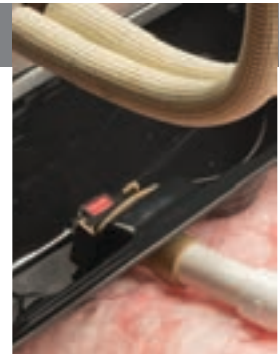

## AG-9100

### External Audible and Visual Remote Alarm

Code	Description	Qty.
96180	Ext. Audio/Visual Alarm	10

#### FEATURES

- No battery required
- Bright white LED alarm
- 103db Audible Alert
- 12 Inches of Lead Wire
- 12-24 VAC / 6-32 VDC circuit
- Audio silence switch

**APPLICATION** • The ONLY multipurpose remote alarm approved for use with AquaGuard condensate management systems. The AG-9100 Audible & Visual Remote Alarm is connected directly to AquaGuard Condensate Management System. When activated, the AG-9100 produces an audible and visual signal. Can be Conveniently Mounted to a Wall, Ceiling, or Directly to a Hot Water Tank or HVAC/R Unit with Two Screws or Included Adhesive Pad Over 250 Feet Away from a Condensate Overflow Switch

- For Use With • AG-1100+ • AG-1200+ • AG-1250E • AG-2550E  
 • AG-3150E • AG-3175E • AG-3180E  
 • AG-4200



# AG-9150E

## Multipurpose Water Sensor & Alarm

Code	Description	Qty.
96190	Multipurpose Water Sensor & Alarm	10

### FEATURES

- Versatile Mounting Options
- Water detection LED
- 6 Feet of Control Wire
- Up to 250 Ft. away from condensate switch
- AG-1250E is UL 508

**APPLICATION** • The AquaGuard AG-9150E is the ultimate condensate management system for any residential or commercial application. The AG-9150E features our award winning AG-1250E Multipurpose Water Sensor combined with our AG-9100 External Audible and Visual Remote Alarm. For metal or plastic secondary pan, floors, walls and basement installations.

- External Audible & Visual Remote Alarm with Five Bright White LED Lights
- 103 Decibel Audible Alert that can be mounted over 250 Feet Away
- 5 Amp, 24 Volts AC Solid State Sensor • Switch Can Be Normally Open or Normally Closed with Automatic Reset • Compact Waterproof Design

US Patent 8,578,770



# AG-9300

## Electronic Condensate Drain Sensors

Code	Description	Qty.
96192	Universal Drain Sensor for Ductless Mini-Split Systems	10
96194	Drain Sensor for Mitsubishi Ductless Mini-Split Systems	10
96196	Drain Sensor for LG Ductless Mini-Split Systems	10



### FEATURES

- Quick and Easy Installation
- Low Battery Audible Alert
- Meets International Building Codes
- UL 508

**APPLICATION** • Each system continuously monitors any condensate overflow in the primary drain pan of any ductless mini-split system, and automatically shuts off the system and activates an alarm if any overflow is detected. • Universal Model is Compatible with All Major Manufacturer's Ductless Mini-Split Systems Currently on the Market

- Additional Models Available with Exclusive Wire Harness Connectors for Mitsubishi, and LG • Long Life Lithium Battery Included (Lasts Up To the Life of the Ductless Mini-Split Unit) • Up to 20 Second Make/Break Delay with Automatic Reset

US Patent 9,038,405





## GOLIATH® CONDENSATE PANS AND RISERS

Goliath®

### Secondary Drain Pans

Code	Pan Size	Outer (Max) Dimension			Inside (Drip Area) Dimension		
		Length	Width	Depth	Length	Width	Depth
96200	26x56"	56.625"	26.5"	2.75"	51.0"	19.5"	2.0"
96202	28x57"	57.25"	28.375"	5.25"	51.75"	21.5"	2.0"
96204	28x69"	69.125"	28.25"	4.25"	66.5"	26.0"	2.0"
96206	30x50"	50.50"	30.25"	4.00"	45.25"	22.75"	2.1"
96208	30x62"	63.00"	30.375"	4.25"	56.875"	22.75"	2.1"
96210	30x66"	66.50"	30.25"	4.00"	64.00"	22.75"	2.1"

#### FEATURES

- Hangable
- Extreme temperature durability
- High tensile strength
- Crack/split/leak/rust resistant
- Self extinguishing



**APPLICATION** • Goliath Series Secondary Drain Pans are the strongest, most rugged HVAC secondary drain pans on the market today • Made With Pride from our own patented blend of advanced polymer DexElar® material, Goliath Series Secondary Drain Pans are engineered with superior one piece structural strength to produce a nearly indestructible drain pan with rolled edges and no seams • Each pan is strong enough to hang using only one pair of steel support struts, ensuring a quick-and-easy professional installation

- Features a network of built-in risers, which are compatible with a wide variety of sizes of HVAC units and eliminate the need to shop around for additional risers or mounting blocks. Some Goliath pans have lower risers when space is restricted • Risers run the length of pan for better strength when hanging • Each pan has specially designed indentations for placement of hanging brackets

- Goliath Series Secondary Drain Pans are compatible with our AG-4200 Condensate Management System water sensor and drain adapter as well as AG-GFR Vibration Isolators to quiet any noisy HVAC unit.

US Patent 7,900,795

*All pans meet or exceed all international building codes and come with a 10 Year Limited Warranty.*

# Goliath®

## Value Series Secondary Drain Pans

Code	Pan Size	Outer (Max) Dimension			Inside (Drip Area) Dimension		
		Length	Width	Depth	Length	Width	Depth
96214	30x50"	50.50"	30.25"	4.00"	45.25"	22.75"	2.1"
96216	30x62"	63.00"	30.375"	4.25"	56.875"	22.75"	2.1"
96218	30x66"	66.50"	30.25"	4.00"	64.00"	22.75"	2.1"

### FEATURES

- Extreme temperature durability
- High tensile strength
- Crack/split/leak/rust resistant
- Self extinguishing



*Goliath Value Series Non-Hangable Secondary Drain Pans are to be used only for fixed placement HVAC installations and must be supported by a solid surface and are not to be hung in any application.*

**APPLICATION** • Goliath Value Series Secondary Drain Pans are the affordable solution for fixed placement, solid surface applications when hanging a secondary drain pan and HVAC unit is not necessary. They are Made with Pride from our patented advanced polymer DexElar® material and feature a network of built-in risers, which are compatible with a wide variety of sizes of HVAC units • Superior strength, durability and versatility when compared to other HVAC secondary drain pans made of traditional ABS plastics. • Will not crack, split, or rust like a metal secondary drain pan • Can support 40% more weight than a traditional ABS plastic pan • Extreme temperature durability -20°F (-28°C) to 260°F (126.7°C) with a higher melting point and self extinguishing characteristics not found in competitors' secondary drain pans • DexElar® material is a safer material of choice than ABS plastic • Are compatible with our AG-4200 Condensate Management System water sensor and drain adapter as well as AG-GFR Vibration Isolators to quiet any noisy HVAC unit.

US Patent 7,900,795

*All pans meet or exceed all international building codes and come with a 5 Year Limited Warranty.*



Goliath & Titan Series are made of DexElar® advanced polymer.

Titan™ Secondary Drain Pans Flexible Series

Code	Pan Size	Outer (Max) Dimension			Inside (Drip Area) Dimension		
		Length	Width	Depth	Length	Width	Depth
96230	24x24"	24.00"	24.00"	2.25"	20.00"	20.50"	2.25"
96232	26x26"	26.00"	26.00"	2.25"	22.00"	22.50"	2.25"
96234	30x30"	30.00"	30.00"	2.25"	26.00"	26.50"	2.25"
96236	32x32"	32.00"	32.00"	2.25"	28.00"	28.50"	2.25"
96238	30x50"	50.50"	30.25"	2.50"	45.00"	22.75"	2.50"
96240	30x62"	63.00"	30.375"	2.50"	56.875"	22.75"	2.50"

**FEATURES**

- Extreme temperature durability
- High tensile strength
- Crack/split/leak/rust resistant
- Self extinguishing



**APPLICATION** • Used when space requirements are tight, the Titan Flexible Series Secondary Drain Pans are more flexible and durable than fabricated metal or plastic pans

• Created from our patented blend of advanced polymer DexElar® material will not rust, crack, split or leak like a traditional fabricated metal secondary drain pan. DexElar® material provides extreme temperature durability (-40°F to 260°F), high tensile strength and is self extinguishing • Titan pans are manufactured with rolled edges and no seams for superior one-piece structural strength and flexibility • They are also specifically designed and engineered to be completely compatible with our Goliath Furnace Series Furnace Risers to create a complete and professional HVAC installation • Made with Pride, Titan Flexible Series Secondary Drain Pans are compatible with our AG-4200 Condensate Management System water sensor and drain adapter.

\* Hangable when properly configured with approved steel supports and pressure treated 4" x 4"s.

All Titan Flexible Series Secondary Drain Pans meet or exceed all international building codes and come with a 3 Year Limited Warranty.



# GOLIATH® FURNACE CONDENSATE PANS

## Goliath® Furnace

### Secondary Drain Pans Furnace Series

Code	Pan Size	Outer (Max) Dimension			Inside (Drip Area) Dimension		
		Length	Width	Depth	Length	Width	Depth
96220*	30x36"	37.50"	30.50"	3.00"	30.75"	23.00"	2.375"
96222	34x64"	64.125"	34.125"	7.50"	59.00"	26.75"	2.1"
96224	34x79"	79.00"	33.75"	7.50"	73.50"	26.50"	2.1"

#### FEATURES

- Extreme temperature durability
- High tensile strength
- Crack/split/leak/rust resistant
- Self extinguishing



All pans meet or exceed all international building codes and come with a 10 Year Limited Warranty.

**APPLICATION** • Goliath Furnace Series Secondary Drain Pans offer all the same benefits and features of our Goliath Series Secondary Drain Pans and are specifically designed for the unique clearance needs of furnace installations and piping requirements • With 7" of clearance, Goliath Furnace pans offer the necessary clearances for any piping that needs to run below a furnace unit – especially with condensing furnace installations. • Made with Pride from our own patented blend of advanced polymer DexElar® material. They are engineered with superior one-piece structural strength to produce a nearly indestructible furnace pan with rolled edges and no seams. Each pan provides extreme temperature durability (-40°F to 260°F), high tensile strength, crack/split/leak/rust resistance, and are self extinguishing. • Goliath Furnace Series Secondary Drain Pans are compatible with our AG-4200 Condensate Management System water sensor and drain adapter as well as 10 AG-GFR Vibration Isolators to quiet the operation of any noisy furnace unit.

\*The Goliath Furnace 30" x 36" x 3.00" pan is designed exclusively for vertical, up flow applications.



Goliath & Titan Series are made of DexElar® advanced polymer.

# Goliath® Furnace

## Riser Kits

Code	Model	Outer (Max) Dimension		
		Length	Width	Height
96254	GFR 28x6	28.50"	7.50"	6.00"
96250	GFR 23x4	22.50"	5.75"	3.625"
96252	GFR 23x7	22.50"	5.75"	6.50"

**FEATURES**

- Constructed of DexElar®, the same durable material as Goliath and Titan HVAC secondary drain pans.
- Will not rust or crack and provide 10x the strength as metal risers.
- Compatible with our Titan secondary drain pans, metal pans or can be used as a standalone.
- Available vibration isolators quiet noisy furnace units.

**APPLICATION** • Goliath Furnace Risers (GFR) are the perfect solution for any furnace installation. GFRs raise furnaces providing the necessary clearance to accommodate piping and p-traps. Available in three sizes, GFR 28x6, GFR 23x4 and GFR 23x7 to accommodate a variety of furnace installation needs. Installation is quick and easy, the GFRs are made to fit either lengthwise or width wise in our Titan pans or fabricated metal pans. DexElar® material is 10X stronger than competing metal risers.

US Patent 8,220,768



*All Goliath Furnace Risers meet or exceed all international building codes and come with a 3 Year Limited Warranty.*



Goliath & Titan Series are made of DexElar® advanced polymer.

## CONDENSATE DRAIN LINE CLEANERS

### Actabs™

#### Drain line biocide

Code	Description	Qty.
68102	EE - 3 tab pouch	50
68108	6 tablet pouch	72
68104	JR - 200 tab bottle	12
68107	DMSS - 200 tab bottle	12

Actabs™ EE	Systems from 1 to 5 tons	EPA Reg. no. 51219-7
Actabs™	Systems from 6 to 15 tons	EPA Reg. no. 51219-7
Actabs™ JR	All systems monthly application	EPA Reg. no. 51219-7
Actabs™ DMSS	Ductless Mini-Split Systems	EPA Reg. no. 51219-7

**APPLICATION** • EPA registered biocide eliminates or prevents most blockages in air conditioning and refrigeration drain lines due to build up of bacterial slime, rust, scale, sludge, airborne dust, silt and other solids

- Lasts up to 3 months. Recommended for • Drain pan
- Computer rooms
- Ductless Mini-Split Systems



### Hydrex™ A/C Tabs

#### A/C drain pan & drain line treatment

Code	Description	Qty.
68115	200 tablet bottle	12

#### FEATURES

- Easily dispensed
- Long lasting

**APPLICATION** • Prevents drain line and pan blockage in air conditioners, humidifiers and refrigerators due to build up of sludge and slime • 2 tablets per one ton of air conditioning controls odor and sludge for up to 3 months Recommended for • Drain pan



### Easy Klear™

#### Clean-out valve

Code	Description	Qty.
97585	¾" line	12

#### FEATURES

- Easy upstream or downstream access to drain line

**APPLICATION** • Three-way clean-out valve for A/C and refrigeration condensate drain lines • Removable cap allows access for shop-vac cleaning • ¼" opening allows access to blow out clogs using CO<sub>2</sub> or nitrogen charges. Recommended for • Condensate drain line



### Nu Line®

#### A/C condensate drain cleaner

Code	Description	Qty.
97685	8 oz.	24
97690	32 oz.	12

#### FEATURES

- Easily dispensed
- Long lasting
- Enzyme based
- Environmentally friendly

**APPLICATION** • Helps prevent A/C drain line clogs and water leaks by preventing accumulation of slime and keeping drain lines open • Use every three months to help prevent mold growth Recommended for • Drain line • Drain pan



# MIGHTY PUMP™ DRAIN LINE MAINTENANCE

## Mighty Pump™

Quickly & completely clear blockage

Code	Description	Qty.
97795	Mighty Pump™	4
97796	Replacement Hoses 2 per bag	6

### FEATURES

- No nitrogen tank or gas cartridges needed
- 2-way flow w/o backflow
- Lightweight, heavy-duty molded PVC
- Easy clean up
- High volume, low pressure

**APPLICATION** • Hand-operated pump that can be used to vacuum or push-out a clogged drain line from inside or outside the home or building • Generates enough pressure to clear slime, mold and dirt plugs  
Recommended for

- Drain Line • A/C condensate pans
- Secondary overflow pans
- Water heater pans • Tubs & toilets

Includes • Pump body • Flexible hoses • Spring check valves  
• 3/4" adapter • Spare O-rings



# Compressor Maintenance

Kickstart®

Acid-Away®

Acid-Away® for POE

Acid-Detector™

Acid-Detector™ for POE

Oil-ID™

Turbo-Kleen™

AC Leak Freeze®



REFRIGERANT LEAK SEALANT

## Polymer-free leak sealants to

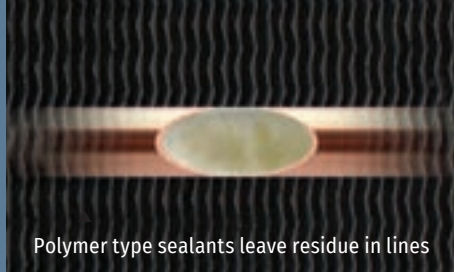

Polymer type sealants leave residue in lines



Leak Freeze is polymer free

- Polymer-free, non-clogging.
- Permanently seals refrigerant leaks.
- Non-flammable • Non-Toxic
- OEM approved.

**New!** AC Leak Freeze PRO.  
Single use injector  
infuses sealant into the system using  
a standard HVAC manifold.





safely extend the life of A/C & refrigerant systems.



AC Leak Freeze

AC Leak Freeze PRO

POLYMER TYPE SEALANT VS AC LEAK FREEZE

**Polymer type sealants**

form a suspended polymer component that clog breaches within the lines to stop leaks. Polymers could also clog compressors, cap tubes, TXV valves and recovery equipment.

Polymer component ► residue remains inside the A/C system.



**AC Leak Freeze**

polymer-free formula safely stops leaks permanently. Keeps A/C lines and internal components clear.

AC Leak Freeze ► remains clear and leaves no residue inside the system.



THREE POLYMER-FREE SEALANT FORMULAS

**AC Leak Freeze Appliance R**

For small appliance and refrigeration systems

**AC Leak Freeze**

For A/C and refrigeration systems

**AC Leak Freeze Magic Frost**

With enhancer for A/C and refrigeration systems



# AC LEAK FREEZE® REFRIGERANT SEALANT

## AC Leak Freeze®

Leak sealant & system enhancer

Code	AC Leak Freeze R - for appliance	Qty.
45301	.5oz	12
45302	.5oz w/1/4" adapter	12

Leak sealant for appliance and refrigeration systems

Code	AC Leak Freeze	Qty.
45311	1.5oz	12
45312	1.5oz w/1/4" adapter	12

Leak sealant for A/C and refrigeration systems

Code	AC Leak Freeze with Magic Frost	Qty.
45321	1.5oz	12
45322	1.5oz w/1/4" adapter	12

Leak sealant and system enhancer for A/C and refrigeration systems



### FEATURES

- Polymer free
- Safe for system
- OEM approved
- Easy to use
- POP blister pack

Code	Adapter Kits	Qty.
45344	1/4" adapter only	5
45345	5/16" adapter only	5

**APPLICATION** • Permanently seal gas leaks in A/C and refrigeration systems • For use in copper and aluminum coils • Polymer-free: non-clogging to compressors, recovery units, schrader valves, cap tubes, TXV valves, micro channels, evacuation equipment and gauges. Recommended for • Sealing small, hard-to-find micro leaks • Revitalizing A/C & refrigeration systems • Enhancing system performance • Reducing compressor noise • Extend compressor life.



◀ 1/4" and 5/16" Adapters also sold separately.



# AC Leak Freeze<sup>®</sup> PRO

Single use leak sealant & system enhancer

Code	AC Leak Freeze	Qty.
45315	1.46 oz PRO	12

Leak sealant for A/C and refrigeration systems

Code	AC Leak Freeze with Magic Frost	Qty.
45325	1.46 oz PRO w/ Magic Frost	12

Leak sealant and system enhancer for A/C and refrigeration systems



### FEATURES

- Single use - disposable
- Polymer-free
- Safe for system
- OEM approved
- Ready to use
- Non-flammable
- Non-toxic

**APPLICATION** • Permanently seal gas leaks in A/C and refrigeration systems • For use in copper and aluminum coils • Polymer free: non-clogging to compressors, recovery units, schrader valves, cap tubes, TXV valves, micro channels, evacuation equipment and gauges • Compatible with all refrigerants. Recommended for • Sealing small, hard-to-find micro leaks • Revitalizing A/C & refrigeration systems • Enhancing system performance • Reducing compressor noise • Extend compressor life.

U. S. Patent Pending

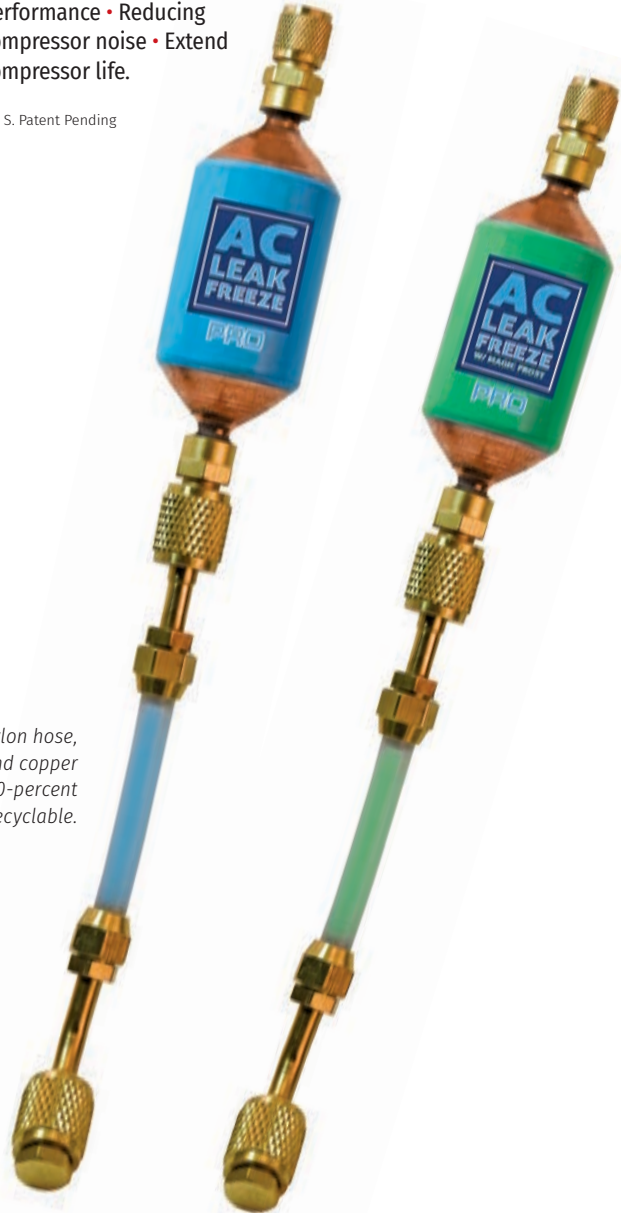

Nylon hose, brass fittings and copper reservoir are all 100-percent recyclable.



COMPRESSOR ACID NEUTRALIZERS

## Revitalize compressors.



### Restore pH balance and A/C performance.

**Acid-Away®** quickly and safely neutralizes harmful A/C acids - the primary cause of compressor burnout. Acid-Away® provides a unique approach to solving the problem of acid buildup in A/C and refrigeration systems that operate using mineral oil or alkylbenzene type refrigerants. It prevents compressor burnouts by neutralizing acid molecules, unlike other products which coagulate to be caught in the filter drier.

**Acid-Away® for POE.** For systems with polyol ester lubricants, use Acid-Away® for POE provides a unique approach to solving the problem of acid build up in A/C and refrigeration systems that operate using polyol ester lubricants. Recommended by compressor manufacturers and proven to neutralize acid after burnouts.



# Acid-Away®

## Compressor burnout acid neutralizer

Code	Description	Qty.
45004	4 oz.	12

### FEATURES

- Stays active in the system to prevent any future acid
- Great for preventive maintenance
- Safe for system components
- Tested to ANSI/ASHRAE standards 86-1983 & 97-1989
- Approved & recommended by OEM's
- More effective than claimed neutralizers or scavengers

**APPLICATION** • Chemical treatment for A/C and refrigeration systems that have experienced a burnout or operating systems that are showing a buildup in acid content • Protects from future burnouts • Neutralizes acid molecules, unlike other products which merely coagulate to be caught in the filter drier  
**Recommended for** • Specifically formulated for both hermetic or semi-hermetic compressors that operate with standard CFC or HCFC refrigerants using mineral oil or alkybenzene type refrigeration oils



# Acid-Away® FOR POE

## Compressor burnout acid neutralizer for POE oils

Code	Description	Qty.
45009	4 oz.	12

### FEATURES

- Removes residual acid
- Compatible with Polyol Ester lubricants
- Great for preventative maintenance
- Tested to ANSI/ASHRAE standards 86-1983 & 97-1989
- Approved & recommended by OEM's

**APPLICATION** • Prevents compressor burnouts by removing the acid buildup that can occur in Polyol Ester refrigeration oils used in A/C and refrigeration systems • Neutralizes acid molecules, unlike other products which merely coagulate to be caught in the filter drier • Specifically formulated for compressors that operate with Polyol Ester oils & is safe for use in all oils





## KICKSTART® ORIGINAL 2-WIRE HARD START DEVICE

The only OEM tested & approved device.

# Kickstart®

### Potential relay & start capacitor



Code	Description	Qty.
96506	KS-1	20
96503	TO-5	20



#### FEATURES

- 2-wire design for easy installation
- 3-year warranty
- Extend the life of compressors
- OEM tested & approved
- Blister packed

**APPLICATION** • 2-wire starting device that uses a mechanical potential relay & start capacitor • Assists compressors in starting under very adverse conditions such as low voltage or high head pressures, extending the life of compressors by providing the correct torque to bring them up to full speed more quickly and efficiently

Recommended for • Single phase 208V, 230V, and 265V A/C, refrigeration and heat pump compressors

- KS-1 handles 3.5 - 5.0 ton
- TO-5 handles 1.0 - 3.0 ton





## ACID-DETECTOR™ & OIL-ID™

Field test kits to detect acid & determine oil types.

### Acid-Detector™

Test kit for alkybenzene & mineral oil

Code	Description	Qty.
45002	Kit	12

#### FEATURES

- Fast acting

**APPLICATION** • Test kit designed for use in the field to detect acid in air conditioning and refrigeration oils • Quickly detects the smallest trace of acids  
Recommended for  
• Mineral Oil • Alkylbenzene type refrigeration oil



### Acid-Detector™ FOR POE

Test kit for POE oils

Code	Description	Qty.
45006	Kit	12

#### FEATURES

- Fast acting

**APPLICATION** • Test kit designed for use in the field to detect acid in Polyol Ester type oil • Quickly detects unacceptable amounts of acid  
Recommended for • POE air conditioning and refrigeration oil



### Oil-ID™

Kit for identifying oil type

Code	Description	Qty.
45001	Kit	12

#### FEATURES

- Cost effective
- Quick & easy to use

**APPLICATION** • Field test kit quickly and easily identifies the type of refrigeration oil used in HVAC-R systems  
• This inexpensive product will tell you within seconds, if the oil being used is a Polyol Ester (POE) oil or not  
Recommended for  
• All types of oil





## A/C SYSTEM MAINTENANCE

### Turbo-Kleen™

Chemically cleans & mechanically scrubs linesets

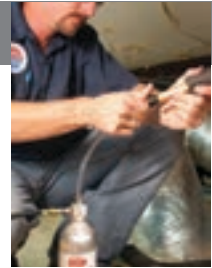

Code	Description	Qty.
82500	Flush Kit	6
82400	1 pt. refill	12
82450	1 gal. refill	4

#### FEATURES

- Unique combination of chemical cleaning and scrubbing
- Stays active during the entire cleaning process
- Low toxicity
- Cost effective, reusable system; only buy refills for future jobs

**APPLICATION** • Quick and less expensive way to completely clean residual oil and contaminants from A/C line sets • Scrubbing action cleans more completely than chemicals alone  
 Recommended for • Retrofits • Refrigerant conversions • Compressor change-outs

#### Kit Includes

- Injector nozzle & canister
- Flushing tool
- Plastic connecting line
- 1 pt. of chemical solution

U. S. Patent No. 8,298,345; 8,734,589



# Airtec Diffusers

Airtec® Classic

Airtec® Retro

Airtec® Tuffbox

# AIRTEC™

ONE PIECE AIR DIFFUSERS

## Our patented 73 second



- Patented one piece grille, damper box.
- Virtually air tight.
- Lightening fast installation.

Virtually air tight butterfly damper  
Rubber gasket delivers superior seal  
when closed.



Stepped Collar for  
multiple duct sizes ▶

Collar tabs easily tear away  
unnneeded sections ▶

Mounting Clip accomodate  
thicknesses up to 1¼"

Damper Handle  
allows smooth, easy turning  
adjustment from below  
for fully open to tightly  
closed position ▶

High Grade Polymer Grille  
resists breakage, scratching,  
yellowing and fading.

USA ★



# diffuser install is the quickest in the trade.



CHOOSE CLASSIC OR RETRO STYLE



## Airtec® Classic GRILLE DAMPER BOX

**Think fast Work smart.®** Our one piece design is virtually air tight, eliminating the need for tedious mastic and external sealers. That cuts attic time. Diffuser installation is no longer a two man job. Labor estimates will be more competitive and you can pocket the profit. You won't want to go back to a metal diffuser ever again.

**Strong, Versatile, Quiet.** Airtec Classic is molded with professional grade polymers for long lasting durability. Choose from five grille styles to deliver the optimum air flow and movement pattern for any room. Stepped collar tears off easily to enlarge duct size to maximize job site flexibility. Virtually air-tight construction ensures efficient and quiet air delivery. Two sizes available.

U. S. Patent No. 6,557,826



## Airtec® Retro GRILLE DAMPER BOX

**Retro style. Same innovation.** Something unexpectedly beautiful for your discriminating customer. Retro diffusers simulate the look of traditional cast iron, to add a sense of warmth missing in contemporary diffusers.

**For Premium Installations.** Distinguish yourself from your competition with Airtec Retro reproduction antique styled air diffusers. Your discerning customer can have the look and feel of a reproduction cast iron grille without the high cost and weight. Simulated cast iron texturing is scratch and rust resistant. Authentic handle turns easily for full range of air flow adjustment. Airtec Retro offers the same advanced technology and labor saving installation time as the standard Airtec diffuser line. Available in black and white. Two sizes available.

U. S. Patent No. 6,557,826

# AIRTEC® DIFFUSER AIR FLOW SPECIFICATIONS



2-way    3-way    4-way    Round    Return/exhaust    Antique

Order code (reference code)

**81912 (MV2) • 81942 (GRD2) • 81832 (GR2)** (8x8") Ak=.33

CFM	PRESSURE LOSS	THROW*	FACE VELOCITY**
55	.006 WG	4.9 ft	164 ft/min
75	.009 WG	6.7 ft	229 ft/min
90	.014 WG	8.0 ft	264 ft/min
110	.021 WG	9.8 ft	330 ft/min
125	.027 WG	11.1 ft	375 ft/min
150	.039 WG	13.4 ft	451 ft/min
175	.053 WG	15.6 ft	533 ft/min
200	.069 WG	17.8 ft	604 ft/min
250	.108 WG	22.3 ft	757 ft/min
300	.156 WG	26.7 ft	909 ft/min
350	.212 WG	31.2 ft	1060 ft/min



Order code (reference code)

**81902 (MV2S) • 81822 (GR2S)** (6x6") Ak=.17

CFM	PRESSURE LOSS	THROW*	FACE VELOCITY**
55	.028 WG	4.5 ft	308 ft/min
75	.054 WG	6.0 ft	421 ft/min
90	.102 WG	7.1 ft	592 ft/min
110	.145 WG	8.9 ft	663 ft/min
125	.181 WG	10.3 ft	785 ft/min
150	.245 WG	11.5 ft	903 ft/min
175	.325 WG	12.6 ft	1045 ft/min
200	.430 WG	14.0 ft	1155 ft/min

Order code (reference code)

**81913 (MV3) • 81943 (GRD3) • 81833 (GR3)** (8x8") Ak=.29

CFM	PRESSURE LOSS	THROW*	FACE VELOCITY**
55	.008 WG	5.0 ft	188 ft/min
75	.014 WG	6.8 ft	255 ft/min
90	.020 WG	8.1 ft	310 ft/min
110	.030 WG	9.9 ft	370 ft/min
125	.038 WG	11.3 ft	445 ft/min
150	.054 WG	13.5 ft	517 ft/min
175	.073 WG	15.8 ft	602 ft/min
200	.095 WG	18.0 ft	689 ft/min
250	.148 WG	22.5 ft	862 ft/min
300	.213 WG	27.0 ft	1034 ft/min
350	.289 WG	31.5 ft	1206 ft/min



Order code (reference code)

**81903 (MV3S) • 81823 (GR3S)** (6x6") Ak=.17

CFM	PRESSURE LOSS	THROW*	FACE VELOCITY**
55	.056 WG	5.3 ft	344 ft/min
75	.075 WG	7.2 ft	426 ft/min
90	.130 WG	8.8 ft	570 ft/min
110	.171 WG	10.2 ft	661 ft/min
125	.230 WG	11.1 ft	785 ft/min
150	.290 WG	11.5 ft	880 ft/min
175	.445 WG	12.1 ft	994 ft/min
200	.545 WG	12.8 ft	1182 ft/min

Throw measurements are equal in all 3 directions +/-5%

Order code (reference code)

**81914 (MV4) • 81944 (GRD4) • 81834 (GR4)** (8x8") Ak=.30

CFM	PRESSURE LOSS	THROW*	FACE VELOCITY**
55	.007 WG	3.9 ft	183 ft/min
75	.011 WG	5.3 ft	247 ft/min
90	.017 WG	6.4 ft	293 ft/min
110	.024 WG	7.8 ft	359 ft/min
125	.030 WG	8.9 ft	410 ft/min
150	.043 WG	10.6 ft	505 ft/min
175	.057 WG	12.4 ft	562 ft/min
200	.073 WG	14.2 ft	640 ft/min
250	.114 WG	17.7 ft	833 ft/min
300	.164 WG	21.3 ft	1000 ft/min
350	.223 WG	24.8 ft	1166 ft/min



Order code (reference code)

**81904 (MV4S) • 81824 (GR4S)** (6x6") Ak=.20

CFM	PRESSURE LOSS	THROW*	FACE VELOCITY**
55	.050 WG	4.5 ft	330 ft/min
75	.085 WG	6.3 ft	361 ft/min
90	.117 WG	7.1 ft	440 ft/min
110	.160 WG	8.2 ft	527 ft/min
125	.200 WG	9.1 ft	605 ft/min
150	.290 WG	10.2 ft	750 ft/min
175	.395 WG	10.9 ft	875 ft/min
200	.490 WG	11.5 ft	962 ft/min

Order code (reference code)

**81911 (MV360) • 81941 (GRD360) • 81831 (GR360)** (8x8") Ak=.33

CFM	PRESSURE LOSS	THROW*	FACE VELOCITY**
55	.002 WG	3.0 ft	161 ft/min
75	.003 WG	3.6 ft	223 ft/min
90	.004 WG	3.8 ft	269 ft/min
110	.005 WG	4.0 ft	328 ft/min
125	.006 WG	5.0 ft	381 ft/min
150	.010 WG	5.5 ft	449 ft/min
175	.015 WG	6.5 ft	527 ft/min
200	.021 WG	7.0 ft	612 ft/min
250	.029 WG	8.0 ft	755 ft/min
300	.038 WG	9.0 ft	904 ft/min
350	.045 WG	10.0 ft	1055 ft/min



Order code (reference code)

**81901 (MV360S) • 81821 (GR360S)** (6x6") Ak=.17

CFM	PRESSURE LOSS	THROW*	FACE VELOCITY**
55	.006 WG	0.8 ft	214 ft/min
75	.009 WG	1.5 ft	284 ft/min
90	.014 WG	2.2 ft	347 ft/min
110	.018 WG	2.3 ft	415 ft/min
125	.025 WG	3.2 ft	437 ft/min
150	.036 WG	4.4 ft	544 ft/min
175	.045 WG	5.5 ft	614 ft/min
200	.060 WG	6.4 ft	699 ft/min

\*All throw measurements are made from the center of the grille to a terminal velocity of 50 feet per minute. Direction determined by grille profile.

\*\*Noise level of any diffuser is directly related to face velocity. As a general rule face velocity should be under 800 FPM for residential applications. The MV diffuser with its one piece molded design, outperforms comparable diffusers causing less turbulence and noise.

Order code (reference code)

**81915 (MVE) • 81945 (GRDE) • 81835 (GRE)** (8x8") Ak=.37

CFM	PRESSURE LOSS	THROW*	FACE VELOCITY**
55	.0005 WG	0.8 ft	92 ft/min
75	.0008 WG	2.1 ft	151 ft/min
90	.0014 WG	3.4 ft	207 ft/min
110	.0017 WG	5.6 ft	255 ft/min
125	.0020 WG	7.8 ft	350 ft/min
150	.0030 WG	9.7 ft	445 ft/min
175	.0050 WG.	11.4 ft	545 ft/min
200	.0080 WG	12.8 ft	700 ft/min
250	.0200 WG	14.1 ft	910 ft/min
300	.0250 WG	14.8 ft	1044 ft/min
350	.0300 WG	15.4 ft	1187 ft/min



Order code (reference code)

**81905( MVES) • 81825 (GRES)** (6x6") Ak=.31

CFM	PRESSURE LOSS	THROW*	FACE VELOCITY**
55	.0008 WG	1.2 ft	146 ft/min
75	.0018 WG	4.2 ft	230 ft/min
90	.0035 WG	6.2 ft	285 ft/min
110	.0043 WG	7.3 ft	338 ft/min
125	.0054 WG	8.7 ft	434 ft/min
150	.0085 WG	9.8 ft	545 ft/min
175	.0100 WG.	11.0 ft	645 ft/min
200	.0110 WG	12.4 ft	685 ft/min

Order code (reference code)

**81916 (MXE)** (8x8") Ak=.37

CFM	PRESSURE LOSS	THROW*	FACE VELOCITY**
55	.0005 WG	0.8 ft	92 ft/min
75	.0008 WG	2.1 ft	151 ft/min
90	.0014 WG	3.4 ft	207 ft/min
110	.0017 WG	5.6 ft	255 ft/min
125	.0020 WG	7.8 ft	350 ft/min
150	.0030 WG	9.7 ft	445 ft/min
175	.0050 WG.	11.4 ft	545 ft/min
200	.0080 WG	12.8 ft	700 ft/min
250	.0200 WG	14.1 ft	910 ft/min
300	.0250 WG	14.8 ft	1044 ft/min
350	.0300 WG	15.4 ft	1187 ft/min



Order code (reference code)

**81906 (MXES)** (6x6") Ak=.31

CFM	PRESSURE LOSS	THROW*	FACE VELOCITY**
55	.0008 WG	1.2 ft	146 ft/min
75	.0018 WG	4.2 ft	230 ft/min
90	.0035 WG	6.2 ft	285 ft/min
110	.0043 WG	7.3 ft	338 ft/min
125	.0054 WG	8.7 ft	434 ft/min
150	.0085 WG	9.8 ft	545 ft/min
175	.0100 WG.	11.0 ft	645 ft/min
200	.0110 WG	12.4 ft	685 ft/min

Order code (reference code)

**81909 (MVAW) • 81949 (GRDAW) • 81839 (GRAW)** (8x8") Ak=.26

CFM	PRESSURE LOSS	THROW*	FACE VELOCITY**
55	.0007 WG	4.0 ft	175 ft/min
75	.0009 WG	6.8 ft	269 ft/min
90	.0021 WG	8.2 ft	383 ft/min
110	.0055 WG	9.9 ft	436 ft/min
125	.0064 WG	11.3 ft	472 ft/min
150	.0085 WG	12.9 ft	593 ft/min
175	.0105 WG.	14.3 ft	693 ft/min
200	.0160 WG	15.3 ft	841 ft/min
250	.0230 WG	16.0 ft	1031 ft/min
300	.0391 WG	17.2 ft	1201 ft/min
350	.0552 WG	17.9 ft	1315 ft/min



Order code (reference code)

**81919 (MVASW) • 81829 (GRASW)** (6x6") Ak=.20

CFM	PRESSURE LOSS	THROW*	FACE VELOCITY**
55	.0085 WG	2.1 ft	277 ft/min
75	.0185 WG	5.0 ft	373 ft/min
90	.0240 WG	7.9 ft	445 ft/min
110	.0375 WG	10.9 ft	550 ft/min
125	.0520 WG	13.3 ft	650 ft/min
150	.0730 WG	14.9 ft	771 ft/min
175	.1010 WG.	16.3 ft	899 ft/min
200	.1200 WG	17.5 ft	988 ft/min

Order code (reference code)

**81918 (MVAB) • 81948 (GRDAB) • 81838 (GRAB)** (8x8") Ak=.26

CFM	PRESSURE LOSS	THROW*	FACE VELOCITY**
55	.0007 WG	4.0 ft	175 ft/min
75	.0009 WG	6.8 ft	269 ft/min
90	.0021 WG	8.2 ft	383 ft/min
110	.0055 WG	9.9 ft	436 ft/min
125	.0064 WG	11.3 ft	472 ft/min
150	.0085 WG	12.9 ft	593 ft/min
175	.0105 WG.	14.3 ft	693 ft/min
200	.0160 WG	15.3 ft	841 ft/min
250	.0230 WG	16.0 ft	1031 ft/min
300	.0391 WG	17.2 ft	1201 ft/min
350	.0552 WG	17.9 ft	1315 ft/min



Order code (reference code)

**81908 (MVASB) • 81828 (GRASB)** (6x6") Ak=.20

CFM	PRESSURE LOSS	THROW*	FACE VELOCITY**
55	.0085 WG	2.1 ft	277 ft/min
75	.0185 WG	5.0 ft	373 ft/min
90	.0240 WG	7.9 ft	445 ft/min
110	.0375 WG	10.9 ft	550 ft/min
125	.0520 WG	13.3 ft	650 ft/min
150	.0730 WG	14.9 ft	771 ft/min
175	.1010 WG.	16.3 ft	899 ft/min
200	.1200 WG	17.5 ft	988 ft/min

Note: Supply diameter has no appreciable effect on characteristics or airflow specifications, but should be consistent with the desired airflow of the particular outlet and application.  
Instruments used in testing: • Shortridge Instruments Flowhood Series 8400 • Shortridge Instruments Air data Multimeter • Davis LCA-6000 Rotating Vane Anemometer

# AIRTEC® CLASSIC/RETRO ORDERING INFORMATION

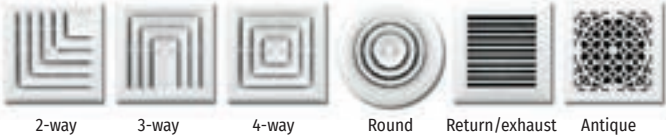

2-way    3-way    4-way    Round    Return/exhaust    Antique

Note: Stepped Collar accommodates:  
6", 7", 8" ducting (MV)    4", 5", 6" ducting (MVS)

## Airtec Classic standard 8x8" diffuser assembly

RS # (ref. #)	DESCRIPTION	CTN QTY	CTN WT
81912 (MV2)	2-way grille/damper/box	4	9 lbs.
81913 (MV3)	3-way grille/damper/box	4	9 lbs.
81914 (MV4)	4-way grille/damper/box	4	9 lbs.
81911 (MV360)	Round grille/damper/box	4	9 lbs.
81915 (MVE)	Return/exhaust grille/damper/box	4	9 lbs.
81916 (MXE)	Return/exhaust grille/box (no damper)	4	9 lbs.

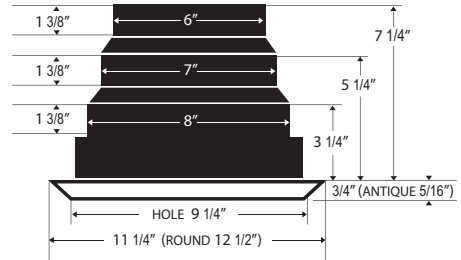

## Airtec Retro standard 8x8" diffuser assembly

RS # (ref. #)	DESCRIPTION	CTN QTY	CTN WT
81909 (MVAW)	Retro White grille/damper/box	4	9 lbs.
81918 (MVAB)	Retro Black grille/damper/box	4	9 lbs.

## Airtec Classic small 6x6" diffuser assembly

RS # (ref. #)	DESCRIPTION	CTN QTY	CTN WT
81902 (MV2S)	2-way grille/damper/box	8	10.5 lbs.
81903 (MV3S)	3-way grille/damper/box	8	10.5 lbs.
81904 (MV4S)	4-way grille/damper/box	8	10.5 lbs.
81901 (MV360S)	Round grille/damper/box	6	7.5 lbs.
81905 (MVES)	Return/exhaust grille/damper/box	8	10.5 lbs.
81906 (MXES)	Return/exhaust grille/box (no damper)	8	10.5 lbs.

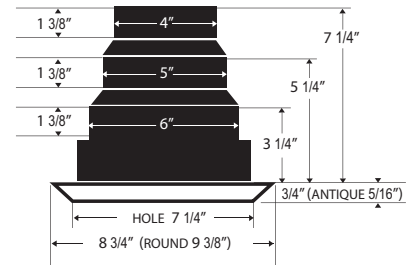

## Airtec Retro small 6x6" diffuser assembly

RS # (ref. #)	DESCRIPTION	CTN QTY	CTN WT
81919 (MVASW)	Retro White grille/damper/box	8	10.5 lbs.
81908 (MVASB)	Retro Black grille/damper/box	8	10.5 lbs.

## Airtec Grille/Damper limited clearance

RS # (ref. #)	DESCRIPTION	CTN QTY	CTN WT
81942 (GRD2)	2-way grille/damper	12	15.8 lbs.
81943 (GRD3)	3-way grille/damper	12	15.8 lbs.
81944 (GRD4)	4-way grille/damper	12	15.8 lbs.
81941 (GRD360)	Round grille/damper	6	7.7 lbs.
81945 (GRDE)	Return/exhaust grille/damper	12	15.8 lbs.
81949 (GRDAW)	Retro grille/damper (white)	12	15.8 lbs.
81948 (GRDAB)	Retro grille/damper (black)	12	15.8 lbs.

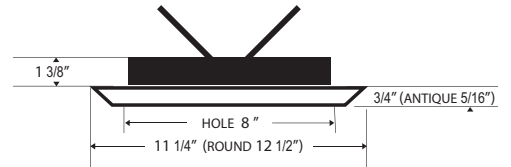

## Airtec Grille standard limited clearance

RS # (ref. #)	DESCRIPTION	CTN QTY	CTN WT
81832 (GR2)	2-way grille	10	6 lbs.
81833 (GR3)	3-way grille	10	6 lbs.
81834 (GR4)	4-way grille	25	6 lbs.
81831 (GR360)	Round grille	15	6 lbs.
81835 (GRE)	Return/exhaust grille	25	6 lbs.
81839 (GRAW)	Retro grille (white)	25	8 lbs.
81838 (GRAB)	Retro grille (black)	10	8 lbs.

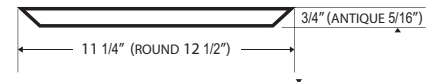

## Airtec Grille small limited clearance

RS # (ref. #)	DESCRIPTION	CTN QTY	CTN WT
81822 (GR2S)	2-way grille small	10	2 lbs.
81823 (GR3S)	3-way grille small	10	2 lbs.
81824 (GR4S)	4-way grille small	10	2 lbs.
81821 (GR360S)	Round grille small	10	4 lbs.
81825 (GRES)	Return/exhaust grille small	10	2 lbs.
81829 (GRASW)	Retro grille small (white)	10	5 lbs.
81828 (GRASB)	Retro grille small (black)	10	5 lbs.

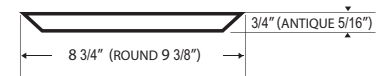



## AIRTEC® ACCESSORIES

### GRD Limited Clearance Diffusers

#### Grille with damper

**Model GRD** grille/damper combination for low clearance side or top entry applications. Same construction as Airtec diffusers but with no boot. Standard 8" size only. Available in all five grille styles.

See page 52 for ordering information.

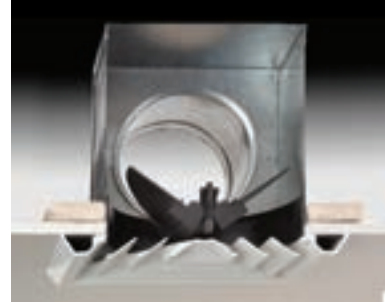

### GR Classic/Retro Grilles

#### Grille only

**Model GR** grille only. All styles and sizes of both Airtec Classic and Airtec Retro grilles are available. Does not include boot or damper.

See page 52 for ordering information.

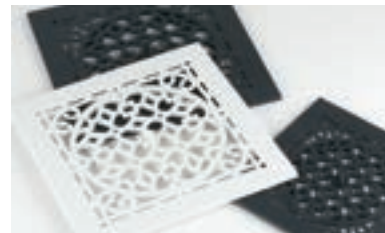

### RCF Ceiling Support Flanges

#### Rough in flanges

RS # (ref. #)	Description	L	W	H	CTN QTY	CTN WT
81965 (RCF16)	16"O/C - 9 <sup>1</sup> / <sub>4</sub> " hole	16"	12"	3/8"	50	37 lbs.
81964 (RCF24)	24"O/C - 9 <sup>1</sup> / <sub>4</sub> " hole	23 <sup>5</sup> / <sub>8</sub> "	12"	3/8"	25	38 lbs.
81955 (RCF16S)	16"O/C - 7" hole	16"	12"	3/8"	50	48 lbs.
81954 (RCF24S)	24"O/C - 7" hole	23 <sup>5</sup> / <sub>8</sub> "	12"	3/8"	25	39 lbs.

**Model RCF** designed for new construction. Our RCF flanges can be fastened to rough framing. It has a 3/8" lip that drops below the ceiling, requiring dry wall installers to cut the hole for you. RCF flanges are available for both 16" and 24" on center framing.



### DCF Drop Ceiling Flanges

#### Flange only

RS # (ref. #)	Description	L	W	H	CTN QTY	CTN WT
81963 (DCF)	24"O/C - 9 <sup>1</sup> / <sub>4</sub> " hole	23 <sup>5</sup> / <sub>8</sub> "	12"	2"	25	45 lbs.
81953 (DCFS)	24"O/C - 7" hole	23 <sup>5</sup> / <sub>8</sub> "	12"	2"	25	48 lbs.

**Model DCF** will increase strength and performance for lay in type ceiling applications by transferring weight onto the T-bars. This prevents tiles from sagging over time.





## AIRTEC® TUFFBOX AIR DIFFUSERS

### Airtec® TuffBox

Quick rough-in polymer register box for HVAC systems

Code	Description	CTN QTY	CTN WT
81966 (MHS)	6x6" Register Box 4,5,6" collars	16	15 lbs.
81968 (MH)	8x8" Register Box 6,7,8" collars	10	12.2 lbs.
81970 (MHL)	10x10" Register Box 8,9,10" collars	8	12 lbs.



Our TuffBox is a heavy, one piece durable polymer shell. Molded design is virtually air-tight to deliver 100% of the air flow passing through it.

Each TuffBox utilizes innovative stepped design to accommodate three duct sizes. Quick breakaway collars allow on-site adjustment, and labor savings. Each collar is  $1\frac{3}{8}$ " and beaded to hold flexible duct in place while strap is secured.  $\frac{5}{8}$ " standoffs provide correct depth to accommodate strapping or furring used with drywall. Secure using screw holes provided or simply screw anywhere through the inside into framing. Flange is flexible to conform to drywall backing virtually eliminating leakage between grille and box.

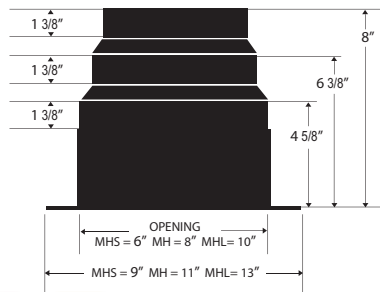

- Adaptable.
- Strong & Silent.
- No measuring.
- No guesswork.

# Lineset Protection

Fortress® Lineset Ducting

Slimduct® Lineset Ducting

**FORTRESS**<sup>®</sup>

LINESET COVER SYSTEM

**SLIMDUCT**<sup>®</sup>

LINESET COVER SYSTEM

Architectural grade polymer



- Professional quality.
- Quick assembly.
- Professional appearance.



Fortress



Slimduct



Both Fortress and Slimduct are now available in convenient kit form. Kit includes duct and fittings for typical mini-split installation.



## lineset ducting. Simple, rugged protection.



CHOOSE FORTRESS OR SLIMDUCT QUALITY



### Fortress® SATIN FINISH

**Moderate price point.** For mini-splits, high velocity and conventional split air conditioning systems.

**Protects** lineset, wiring and drain hose from weather, vandalism, pet and pest damage.

**Snap together ducting** easily accessed for repairs or replacement of the lineset.

**UV and weather resistant.** Will remain attractive and provide protection for many years.

**Stylish.** Compliments any residential or commercial building. Paintable. Brush, spray or roller to match or compliment custom colors.\*

**Two sizes.** Duct & fittings are available in both LD92 (3½"), LD122 (4½")

**Four color options** white, ivory, brown, gray

**8ft duct lengths.** 6 lengths per box

**17 fittings.** Assures complete flexibility of installation

**1 year warranty.**



### Slimduct® GLOSS FINISH

**Heavy duty grade.** For mini-splits, high velocity and conventional ducted air conditioning systems. Protects lineset, wiring and drain hose from weather, vandalism, pet and pest damage.

**Snap together ducting** easily accessed for repairs or replacement of the lineset.

**UV, weather and fire resistant.** Temperature range from -4°F to 140°F. Will remain attractive and provide protection for many years.

**Stylish.** Compliments any residential or commercial building.

**Three sizes.** Duct & fittings are available in SD77 (2¾"), SD100 (3¾"), SD140 (5½")

**Three color options.** white, ivory, brown

**78 in duct lengths.** 5 lengths per box

**15 fittings.** Assures complete flexibility of installation

**1 year warranty.**



















\*Follow paint manufacturers recommendations for vinyl products. NOTE: Dark colors fade in sunlight sooner than lighter colors.

# FORTRESS® LINESET COVER ORDERING INFORMATION

**Longer 8ft ducting** minimizes joints and reduces waste.

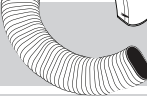
**Paintable.** Brush, spray or roller to match or compliment custom colors. Follow paint manufacturers recommendations for vinyl products.



	MODEL	SIZE	DESCRIPTION	L	W	H
	LD92	3 1/2	Ducting	96"	3 5/8"	2 5/8"
	LD122	4 1/2	Ducting	96"	4 5/8"	3 1/4"
	LJ92	3 1/2	Coupler	2 5/8"	3 7/8"	2 3/4"
	LJ122	4 1/2	Coupler	2 5/8"	4 7/8"	3 1/2"
	LW92	3 1/2	Wall Inlet	9"	4 3/8"	3 1/8"
	LW122	4 1/2	Wall Inlet	9 3/4"	5 3/8"	4"
	LEN92	3 1/2	End Fitting	4 1/4"	3 7/8"	2 3/4"
	LEN122	4 1/2	End Fitting	4 1/4"	4 7/8"	3 1/2"
	LK92	3 1/2	90° Flat Ell	5 3/4"	5 3/4"	2 3/4"
	LK122	4 1/2	90° Flat Ell	6 1/4"	6 1/2"	3 1/2"
<i>Above fittings now also available in LDK Kit pack (shown right)</i>						
	LP92	3 1/2	Soffit Inlet	3 1/2"	6"	4 7/8"
	LP122	4 1/2	Soffit Inlet	3 1/2"	7"	5 1/2"
	LKF92	3 1/2	45° Flat Ell	4 7/8"	4 7/8"	2 3/4"
	LKF122	4 1/2	45° Flat Ell	6 1/2"	6 1/2"	3 1/2"
	LCI92	3 1/2	90° Inside Vertical Ell	5 1/4"	5 1/4"	2 3/4"
	LCI122	4 1/2	90° Inside Vertical Ell	5 1/4"	5 1/4"	3 1/2"
	LCO92	3 1/2	90° Outside Vertical Ell	4 1/2"	4 1/2"	2 3/4"
	LCO122	4 1/2	90° Outside Vertical Ell	5 1/4"	5 1/4"	3 1/2"
	LCFI92	3 1/2	45° Inside Vertical Ell	4 3/4"	3 7/8"	2 3/4"
	LCFI122	4 1/2	45° Inside Vertical Ell	6 1/4"	4 7/8"	3 1/2"
	LCFO92	3 1/2	45° Outside Vertical Ell	4 5/8"	3 7/8"	2 3/4"
	LCFO122	4 1/2	45° Outside Vertical Ell	5 1/4"	4 7/8"	3 1/2"
	LT92	3 1/2	Tee	7 3/4"	5 3/4"	2 3/4"
	LT122	4 1/2	Tee	7 3/4"	6 1/2"	3 1/2"
	LDR12292	3 1/2 - 4 1/2	Reducer	3"	4 7/8"	3 7/8"
	LKS92	3 1/2	90° Sweep Ell	13"	13"	2 3/4"
	LKS122	4 1/2	90° Sweep Ell	14"	14"	3 1/2"
	LF92	3 1/2	Flexible Ell	40"	3 1/2"	2 1/2"
	LF122	4 1/2	Flexible Ell	40"	4 1/2"	3 1/4"
	LFJ92	3 1/2	Flexible Adaptor	3 1/8"	3 7/8"	2 3/4"
	LFJ122	4 1/2	Flexible Adaptor	3 1/8"	4 7/8"	3 1/2"
	LWF92	3 1/2	Wall Flange	5"	6"	2 1/8"
	LWF122	4 1/2	Wall Flange	6 1/2"	7 3/4"	2 5/8"
	LDC	-	Twistlock Lineset Duct Clip	-	-	-

<b>WHITE</b>		<b>IVORY</b>		<b>BROWN</b>		<b>GRAY</b>	
Order code / Ref No	Qty	Order code / Ref No	Qty	Order code / Ref No	Qty	Order code / Ref No	Qty
84004 (LD92W)	6	84024 (LD92I)	6	84064 (LD92B)	6	84044 (LD92G)	6
84104 (LD122W)	6	84124 (LD122I)	6	84164 (LD122B)	6	84144 (LD122G)	6
84010 (LJ92W)	6	84030 (LJ92I)	6	84270 (LJ92B)	1	84250 (LJ92G)	1
84110 (LJ122W)	6	84130 (LJ122I)	6	84370 (LJ122B)	1	84350 (LJ122G)	1
84016 (LW92W)	6	84036 (LW92I)	6	84276 (LW92B)	1	84256 (LW92G)	1
84116 (LW122W)	6	84136 (LW122I)	6	84376 (LW122B)	1	84356 (LW122G)	1
84007 (LEN92W)	6	84027 (LEN92I)	6	84267 (LEN92B)	1	84247 (LEN92G)	1
84107 (LEN122W)	6	84127 (LEN122I)	6	84367 (LEN122B)	1	84347 (LEN122G)	1
84011 (LK92W)	6	84031 (LK92I)	6	84271 (LK92B)	1	84251 (LK92G)	1
84111 (LK122W)	6	84131 (LK122I)	6	84371 (LK122B)	1	84351 (LK122G)	1
84014 (LP92W)	6	84034 (LP92I)	6	84274 (LP92B)	1	84254 (LP92G)	1
84114 (LP122W)	6	84134 (LP122I)	6	84374 (LP122B)	1	84354 (LP122G)	1
84012 (LKF92W)	6	84032 (LKF92I)	6	84272 (LKF92B)	1	84252 (LKF92G)	1
84112 (LKF122W)	6	84132 (LKF122I)	6	84372 (LKF122B)	1	84352 (LKF122G)	1
84002 (LCI92W)	6	84022 (LCI92I)	6	84262 (LCI92B)	1	84242 (LCI92G)	1
84102 (LCI122W)	6	84122 (LCI122I)	6	84362 (LCI122B)	1	84342 (LCI122G)	1
84003 (LCO92W)	6	84023 (LCO92I)	6	84263 (LCO92B)	1	84243 (LCO92G)	1
84103 (LCO122W)	6	84123 (LCO122I)	6	84363 (LCO122B)	1	84343 (LCO122G)	1
84000 (LCFI92W)	6	84020 (LCFI92I)	6	84260 (LCFI92B)	1	84240 (LCFI92G)	1
84100 (LCFI122W)	6	84120 (LCFI122I)	6	84360 (LCFI122B)	1	84340 (LCFI122G)	1
84001 (LCFO92W)	6	84021 (LCFO92I)	6	84261 (LCFO92B)	1	84241 (LCFO92G)	1
84101 (LCFO122W)	6	84121 (LCFO122I)	6	84361 (LCFO122B)	1	84341 (LCFO122G)	1
84015 (LT92W)	6	84035 (LT92I)	6	84275 (LT92B)	1	84255 (LT92G)	1
84115 (LT122W)	6	84135 (LT122I)	6	84375 (LT122B)	1	84355 (LT122G)	1
84106 (LDR12292W)	6	84126 (LDR12292I)	6	84366 (LDR12292B)	1	84346 (LDR12292G)	1
84013 (LKS92W)	6	84033 (LKS92I)	6	84273 (LKS92B)	1	84253 (LKS92G)	1
84113 (LKS122W)	6	84133 (LKS122I)	6	84373 (LKS122B)	1	84353 (LKS122G)	1
84008 (LF92W)	6	84028 (LF92I)	6	84268 (LF92B)	1	84248 (LF92G)	1
84108 (LF122W)	6	84128 (LF122I)	6	84368 (LF122B)	1	84348 (LF122G)	1
84009 (LFJ92W)	6	84029 (LFJ92I)	6	84269 (LFJ92B)	1	84249 (LFJ92G)	1
84109 (LFJ122W)	6	84129 (LFJ122I)	6	84369 (LFJ122B)	1	84349 (LFJ122G)	1
84017 (LWF92W)	6	84037 (LWF92I)	6	84277 (LWF92B)	1	84257 (LWF92G)	1
84117 (LWF122W)	6	84137 (LWF122I)	6	84377 (LWF122B)	1	84357 (LWF122G)	1
<b>84099 (LDC) (12 pk 50 bags)</b>							

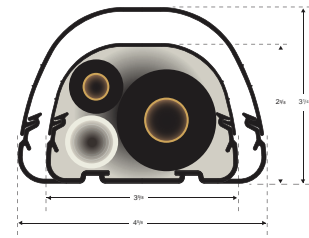

### Technical Information

**Weather resistant PVC,**  
UV stabilized & fire resistant.  
Tested to over 2,000 hours.  
**Temperature Range**  
-4° F to 140° F



### 12' Wall Duct Kit

Kit includes 12' of duct and all essential fittings to hide and protect the lineset for a typical A/C installation. Available in white, ivory, gray and brown

### LDK Kit includes:

- LD - Ducting 4' Long (3)
- LJ - Couplers (2)
- LW - Wall Inlet (1)
- LEN - End Fitting (1)
- LK- 90° Flat Ell (1)

### Fortress Kits:

- 84045 LDK92G - Gray 3 1/2
- 84145 LDK122G - Gray 4 1/2
- 84065 LDK92B - Brown 3 1/2
- 84165 LDK122B - Brown 4 1/2
- 84005 LDK92W - White 3 1/2
- 84105 LDK122W - White 4 1/2
- 84025 LDK92I - Ivory 3 1/2
- 84125 LDK122I - Ivory 4 1/2



*Ducting and fittings packaged 6 per box helps minimize inventory*

# SLIMDUCT® LINESET COVER ORDERING INFORMATION

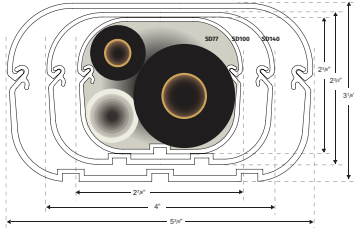

**Technical Information**  
**Weather resistant PVC,**  
 UV stabilized & fire resistant.  
 Tested to over 2,000 hours.  
**Temperature Range**  
 -4° F to 140° F



















**NEW!**  
**13' Wall Duct Kit**  
 Kit includes 13' of duct and all essential fittings to hide and protect the lineset for a typical A/C installation. Available in white only.

**SDK Kit includes:**  
 SD - Ducting 39' Long (4)  
 SJ - Couplers (2)  
 SW - Wall Inlet (1)  
 SEN - End Fitting (1)  
 SK- 90° Flat Ell (1)

**Slimduct Kits:**  
 85005 SDK77W - 2 3/4" White kit  
 85105 SDK100W - 3 3/4" White kit

*Duct is packaged  
 5 per box.  
 Fittings are packed  
 5 or 10 per box.*

Description	L	W	H	RS# (ref. #) White	RS# (ref. #) Ivory	RS# (ref. #) Brown
 SD Slimduct 78" L - 77	78"	2 7/8"	2 3/8"	85004 (SD-77-W)	85024 (SD-77-I)	85064 (SD-77-B)
SD Slimduct 78" L - 100	78"	4"	2 3/4"	85104 (SD-100-W)	85124 (SD-100-I)	85164 (SD-100-B)
SD Slimduct 78" L - 140	78"	5 3/8"	3 1/4"	85204 (SD-140-W)	85224 (SD-140-I)	85264 (SD-140-B)
 SJ coupler 77	2"	3 3/8"	2 5/8"	86010 (SJ-77-W)	86030 (SJ-77-I)	85370 (SJ-77-B)
SJ coupler 100	2 1/2"	4 1/4"	3"	86110 (SJ-100-W)	86130 (SJ-100-I)	85470 (SJ-100-B)
SJ coupler 140	3 1/2"	5 3/4"	3 3/8"	86210 (SJ-140-W)	86230 (SJ-140-I)	85570 (SJ-140-B)
 SW wall inlet 77	8"	4 3/8"	3"	86016 (SW-77-W)	86036 (SW-77-I)	85376 (SW-77-B)
SW wall inlet 100	8 3/4"	5"	3 3/8"	86116 (SW-100-W)	86136 (SW-100-I)	85476 (SW-100-B)
SW wall inlet 140	11"	6 1/2"	3 3/8"	85216 (SW-140-W)	85236 (SW-140-I)	85576 (SW-140-B)
 SP soffit inlet 77	5 1/8"	4 3/8"	5 1/8"	85014 (SP-77-W)	85034 (SP-77-I)	85374 (SP-77-B)
SP soffit inlet 100	5 3/8"	5 3/8"	5 3/8"	86114 (SP-100-W)	86134 (SP-100-I)	85474 (SP-100-B)
SP soffit inlet 140	5 3/4"	6 7/8"	5 3/4"	85214 (SP-140-W)	85234 (SP-140-I)	85574 (SP-140-B)
 SEN end fitting 77	1 3/4"	3 3/4"	2 5/8"	86007 (SE/SEN-77-W)	86027 (SE/SEN-77-I)	85367 (SE/SEN-77-B)
SEN end fitting 100	4 1/2"	4 1/4"	3"	86107 (SEN-100-W)	86127 (SEN-100-I)	85467 (SEN-100-B)
SEN end fitting 140	6"	5 3/4"	3 3/8"	86207 (SEN-140-W)	86227 (SEN-140-I)	85567 (SEN-140-B)
 SK 90° flat ELL 77	5"	2 5/8"	5"	86011 (SK-77-W)	86031 (SK-77-I)	85371 (SK-77-B)
SK 90° flat ELL 100	6"	3"	6"	86111 (SK-100-W)	86131 (SK-100-I)	85471 (SK-100-B)
SK 90° flat ELL 140	7 1/2"	3 3/8"	7 1/2"	85211 (SK-140-W)	85231 (SK-140-I)	85571 (SK-140-B)
 SKF 45° flat ELL 77	4 1/2"	3 1/4"	2 5/8"	85012 (SKF-77-W)	85032 (SKF-77-I)	85372 (SKF-77-B)
SKF 45° flat ELL 100	5 1/4"	4 1/4"	3"	86112 (SKF-100-W)	86132 (SKF-100-I)	85472 (SKF-100-B)
SKF 45° flat ELL 140	6 1/4"	5 3/4"	3 3/8"	85212 (SKF-140-W)	85232 (SKF-140-I)	85572 (SKF-140-B)
 SC 90° vertical ELL 77	4"	3 1/4"	4"	86002 (SC-77-W)	86022 (SC-77-I)	85362 (SC-77-B)
SC 90° vertical ELL 100	4 5/8"	4 1/4"	4 5/8"	86102 (SC-100-W)	86122 (SC-100-I)	85462 (SC-100-B)
SC 90° vertical ELL 140	5"	5 3/4"	5"	85202 (SC-140-W)	85222 (SC-140-I)	85562 (SC-140-B)
 SCF 45° vertical ELL 77	4 1/8"	3 1/4"	2 5/8"	85000 (SCF-77-W)	85020 (SCF-77-I)	85360 (SCF-77-B)
SCF 45° vertical ELL 100	4 3/8"	4 3/8"	3"	86100 (SCF-100-W)	86120 (SCF-100-I)	85460 (SCF-100-B)
SCF 45° vertical ELL 140	4 5/8"	5 3/8"	3 3/8"	85200 (SCF-140-W)	85220 (SCF-140-I)	85560 (SCF-140-B)
 ST TEE 77	6 1/2"	4 7/8"	2 5/8"	86015 (ST-77-W)	86035 (ST-77-I)	85375 (ST-77-B)
ST TEE 100	7 7/8"	6"	3"	86115 (ST-100-W)	86135 (ST-100-I)	85475 (ST-100-B)
ST TEE 140	9 7/8"	7 7/8"	3"	85215 (ST-140-W)	85235 (ST-140-I)	85575 (ST-140-B)
 SDR reducer 100-77	2 1/2"	4 1/4"	3"	85106 (SDR-100-77-W)	85126 (SDR-100-77-I)	85466 (SDR-100-77-B)
SDR reducer 140-100	4"	5 3/4"	3 3/8"	86206 (SDR-140-100-W)	86226 (SDR-140-100-I)	85566 (SDR-140-100-B)
 SIF 2" fixed offset 77	7 1/8"	3 3/4"	3 1/4"	86018 (SIF-77-W)	86038 (SIF-77-I)	85378 (SIF-77-B)
SIF 2" fixed offset 100	7 1/8"	4 1/4"	4 1/4"	86118 (SIF-100-W)	86138 (SIF-100-I)	85478 (SIF-100-B)
 SN 2.75" Twist ELL 77	5 1/2"	5 1/2"	3 1/8"	85080 (SN-77-W)	85085 (SN-77-I)	85395 (SN-77-B)
 SF flex ELL 20" L-77-500	19 1/2"	3"	2 1/2"	85008 (SF-77-500-W)	85028 (SF-77-500-I)	85368 (SF-77-500-B)
SF flex ELL 31" L-100-800	31 1/2"	4"	2 3/4"	86108 (SF-100-800-W)	86128 (SF-100-800-I)	85468 (SF-100-800-B)
SF flex ELL 31" L-140-800	31 1/2"	5 3/4"	3 3/8"	85208 (SF-140-800-W)	85228 (SF-140-800-I)	85568 (SF-140-800-B)
 SFJ flex adaptor 77	1 3/8"	3 1/4"	3 1/4"	85009 (SFJ-77-W)	85029 (SFJ-77-I)	85369 (SFJ-77-B)
SFJ flex adaptor 100	1 1/2"	4 1/4"	4 1/4"	85109 (SFJ-100-W)	85129 (SFJ-100-I)	85469 (SFJ-100-B)
 SFS saddle for flex ELL 77	1 3/8"	3 1/4"	2 1/2"	86001 (SFS-77)	-	-
SFS saddle for flex ELL 100	1 1/2"	3 1/4"	3"	86101 (SFS-100)	-	-
SFS saddle for flex ELL 140	1 1/2"	4 1/4"	3"	86201 (SFS-140)	-	-
 SL strap kit for line sets	-	-	-	86299 (SL-300)	-	-

(stainless steel)

# Locking Refrigerant Caps

Novent® R410 Caps

Novent® R22 Caps

Novent® Universal Caps

# NOVENT®

LOCKING REFRIGERANT CAPS

## Meet IMC® IRC® code

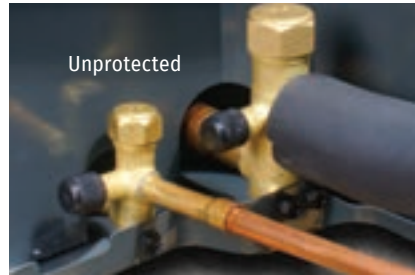

- Protect children.
- Protect homeowners from liability.
- Protect refrigerant levels and A/C system efficiency.
- Simple screw-on application.



**Inhalant Abuse.** Breathing in vapor or gases to reach a high or altered state of mind, commonly called "Huffing, Sniffing, Bagging

or Dusting". Inhalants are legal and found in everyday products like glue, paint and the refrigerant gas (Freon) in your A/C unit.

Over 2.6 million children, aged 12-17 use inhalant each year to get high. Special tools are required to

apply and remove the caps, making it difficult for non-professionals to access the refrigerant.

**Proven, instant protection.** Novent® protects lineset refrigerant gas against intoxication by inhalation of toxic refrigerant gas. Special tools are required to apply and remove the caps, making it difficult to access the refrigerant. They are code compliant, proven to reduce venting, energy loss, and provide protection from serious injury or homeowner liability.

**Insist on code compliant caps.** Effective February 2009 the International Mechanical Code and International Residential Code require that all outdoor access ports on AC Refrigerant circuits be fitted with locking-type caps to make tamper resistant. Novent® locking AC refrigerant caps are the proven code compliant solution in the marketplace.





## NOVENT® LOCKING REFRIGERANT CAPS

Dual protection. Simple key style installation.

### Novent® Silver

Any gas, 1/4" thread, key

Code	Description	Qty.
86692 (NS-UNI)	2 cap blister	20
86691 (NS-UNI)	10 cap blister	10
86693 (NS-UNI)	50 cap box	1
86694 (NS-UNI)	100 pack	1

#### FEATURES

- Resists crushing & removal without key
- Corrosion resistant anodized aluminum
- Integral neoprene O-ring resists oils & sealants
- Torque limiter prevents overtightening

**APPLICATION** • Seals standard Schrader service valves on all central A/C units and mini-splits to help prevent refrigerant leakage

- Protects from serious injury or death resulting from the inhalation of dangerous gases

1/4" Thread **Silver** (any gas)

Patent No. 6,612,455



### Novent® Pink

R410, 1/4" thread & Euro 5/16" thread, key

Code	Description	Qty.
86682 (NP-R410)	2 cap blister 1/4"	20
86681 (NP-R410)	10 cap blister 1/4"	10
86683 (NP-R410)	50 cap box 1/4"	1
86684 (NP-R410)	100 pack 1/4"	1
86672 (NPE-R410)	2 cap blister 5/16"	20
86671 (NPE-R410)	10 cap blister 5/16"	10
86673 (NPE-R410)	50 cap box 5/16"	1

#### FEATURES

- Resists crushing & removal without key
- Corrosion resistant anodized aluminum
- Integral neoprene O-ring resists oils & sealants
- Torque limiter prevents overtightening

**APPLICATION** • Seals standard Schrader service valves on all central A/C units and mini-splits to help prevent refrigerant leakage

- Protects from serious injury or death resulting from the inhalation of dangerous gases

1/4" Thread **Pink** (R410 gas)

5/16" Thread **Pink** (R410 gas)

Patent No. 6,612,455



### Novent® Green

R22, 1/4" thread, key

Code	Description	Qty.
86662 (NG-R22)	2 cap blister	20
86661 (NG-R22)	10 cap blister	10
86663 (NG-R22)	50 cap box	1
86664 (NG-R22)	100 pack	1

#### FEATURES

- Resists crushing & removal without key
- Corrosion resistant anodized aluminum
- Integral neoprene O-ring resists oils & sealants
- Torque limiter prevents overtightening

**APPLICATION** • Seals standard Schrader service valves on all central A/C units and mini-splits to help prevent refrigerant leakage

- Protects from serious injury or death resulting from the inhalation of dangerous gases

1/4" Thread **Green** (R22 gas)

Patent No. 6,612,455



# NOVENT® LOCKING REFRIGERANT CAPS

Continued

## Novent® Starter Pack

### Caps & keys

Code	Description	Qty.
86668 (NG-STARTPACK)	(3) R22, (3) R410 caps (1) Multikey	10
86680 (NP-STARTPACK)	(6) R410 caps (1) Multikey	10
86690 (NG-STARTPACK)	(6) Uni caps (1) Multikey	10

#### FEATURES

- Resists crushing & removal without key
- Corrosion resistant anodized aluminum
- Integral neoprene O-ring resists oils & sealants
- Torque limiter prevents overtightening

**APPLICATION** • Seals standard Schrader service valves on all central A/C units and mini-splits to help prevent refrigerant leakage • Protects from serious injury or death resulting from the inhalation of dangerous gases Recommended for • All types of refrigerants; Color coded caps and embossed ID prevent refrigerant gas mixing

1/4" Thread **Silver**  
(any gas)

1/4" Thread **Pink**  
(R410 gas)

1/4" Thread **Green**  
(R22 gas)



Patent No. 6,612,455

## Novent® Keys

### Special installer and removal key for Novent Caps

Code	Description	Qty.
86698 (NVMULTIKEY)	Multikey blister	20
86688 (NP-R410SDT)	Pink screwdriver	20
86660 (NG-R22-SDT)	Uni & green screwdriver	20

#### FEATURES

- Selection of installation tools available
- Corrosion resistant



**APPLICATION** • Patented Novent Caps are precision machined from high grade brass surrounded by a protective aluminum shroud and can only be installed and removed with a special tool. Recommended for • All types of Novent refrigerants

Patent No. 6,612,455





# Mounting & Installation

Big Foot® Mounting

Fast Fix Stands

Frame Supports

Universal Brackets

Risers

NoKink™

Mighty Bracket™

Paircoil

Aspen® Xtra



EQUIPMENT MOUNTING

# The industry standard for



- Quick setup & Leveling
- Rugged equipment support
- Modular flexibility

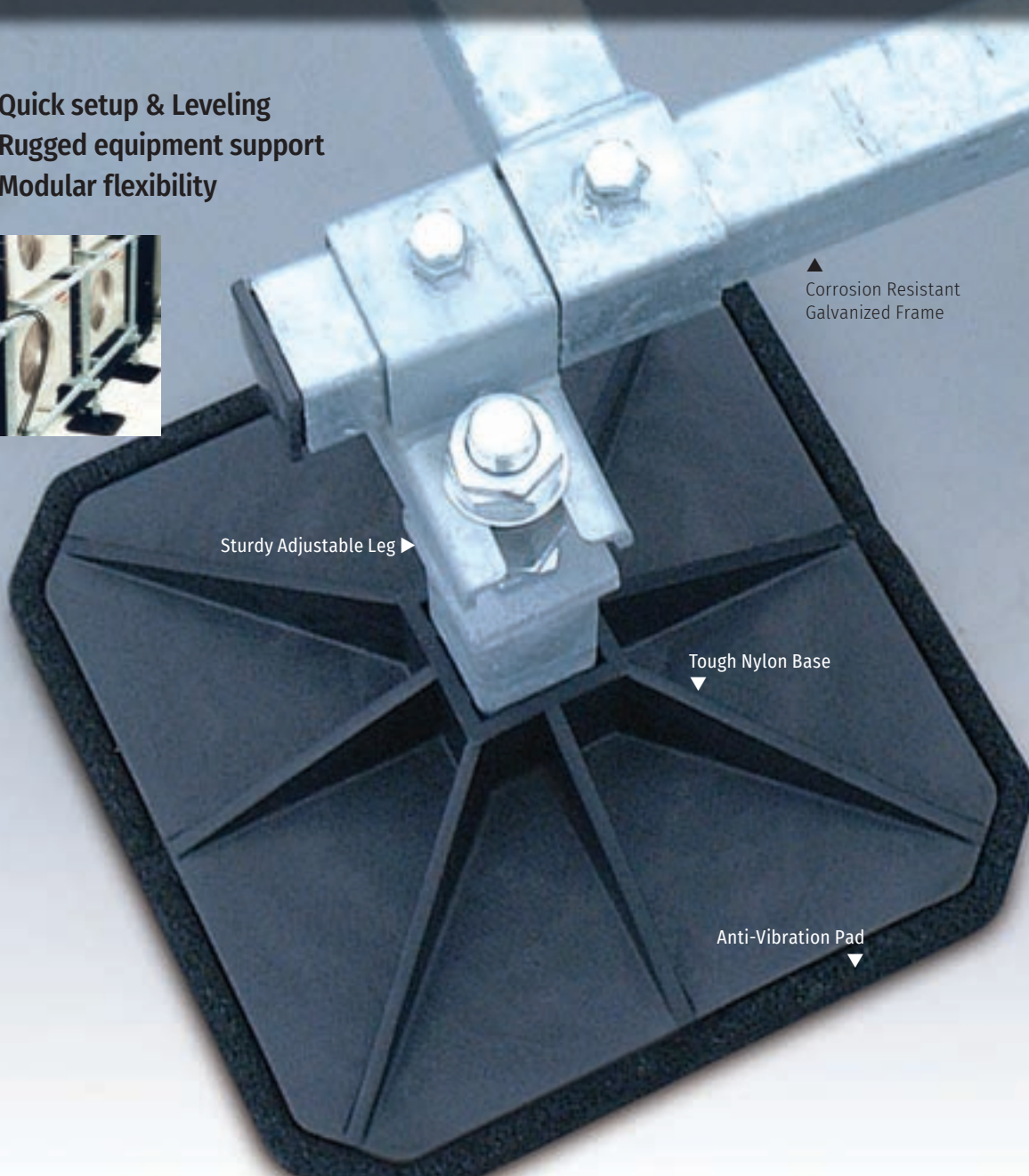

▲ Corrosion Resistant Galvanized Frame

▶ Sturdy Adjustable Leg

▼ Tough Nylon Base

▼ Anti-Vibration Pad

Big Foot is a registered trademark of Aspen Pumps Limited Company UK | Big Foot Systems is a registered trademark of Aspen Pumps Limited Company UK

# free standing flat roof equipment mounting.



## THE ADVANTAGES OF BIG FOOT FRAMEWORKS

**The industry standard.** Big Foot Systems set the industry standard for free standing flat roof equipment mounting of air conditioning, refrigeration and other associated services.

**Rugged stance.** There are no limits to what can be supported with a Big Foot System. Mounting is strong, secure, flexible, vibration absorbing, and leak proof. Installation is quick, clean, practical and aesthetically pleasing.

**Modular flexibility.** The system is modular and completely flexible. Custom designs offer the ability to change any part of the design of the frame at any time to increase or reduce weight loading.

**Removable legs.** Big Foot system legs can be removed individually. Costly removal of equipment is unnecessary when re-roofing or resurfacing. Optimum weight distribution. The Big Foot base is designed to transfer weight beyond the center stress point.

**Optimum strength and longevity.**

The Big Foot base is made of glass filled Nylon with UV protection. Frameworks are hot dip galvanized for all weather protection.

**Quiet durability.** An independent anti-vibration mat is provided for each foot.

**Quick on-site leveling.** The legs allow for vertical height adjustment to permit easy leveling. An extended leg set option is available for stepped roof applications.

**Reduced risk of roof leaks.** The Big Foot System does not penetrate the waterproof membrane, eliminating difficult flashing around concrete structures. The roofing system warranty is never compromised.

**Architecturally friendly.** Big Foot clean contemporary framework suspends roofing equipment above the roof surface, allowing for a simpler, more flexible roof design.

**Custom Frameworks**

For larger, more complex projects, Big Foot offers a custom frame design service. With a plan of your roof and dimensions/weights of the equipment, we can specify standard Big Foot system framework to support up to 10 tons.

Contact RectorSeal 1-800-231-3345

EXTENDED LEG SET OPTION

Code	Description	Qty.
87816	Ext. leg set -12" foot (2)	2
87817	Ext. leg set -18" foot (2)	2



Extended Leg set provides 32" of step adjustment.

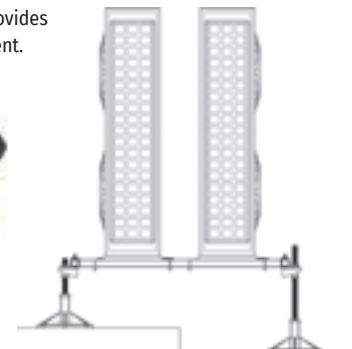



## BIG FOOT SYSTEMS® VRF CONDENSER FRAMEWORKS

Prefabricated flat roof support for larger multiple VRF condenser application.

Non-penetrative. 59" wide.

### VRF Condenser Frameworks



### VRF Frameworks

### Specialty Frames for VRF Condensers

Code	Model	Description	VRF Dim.	Frame Dim.	Support wt.	Frame wt.	Qty.
87721	(VRF1000)	4 pad framework	37" x 30"	39" x 59"	1,056 lbs	108 lbs	1
87621	(VRF1500)	4 pad framework	49" x 30"	59" x 59"	1,056 lbs	117 lbs	1
87722	(VRF2000)	6 pad framework	69" x 30"	78" x 59"	1,584 lbs	155 lbs	1
87723	(VRF2500)	6 pad framework	73" x 30"	98" x 59"	1,584 lbs	161 lbs	1
87724	(VRF3000)	8 pad framework	104" x 30"	118" x 59"	2,112 lbs	194 lbs	1
87622	(VRF3500)	8 pad framework	100" x 30"	118" x 59"	2,112 lbs	194 lbs	1
87725	(VRF4000)	8 pad framework	117" x 30"	137" x 59"	2,112 lbs	216 lbs	1
87623	(VRF4500)	8 pad framework	120" x 30"	137" x 59"	2,112 lbs	216 lbs	1
87624	(VRF5000)	10 pad framework	117" x 30"	157" x 59"	2,640 lbs	279 lbs	1
87625	(VRF5500)	10 pad framework	145" x 30"	157" x 59"	2,640 lbs	157 lbs	1
87726	(VRF6000)	10 pad framework	142" x 30"	157" x 59"	2,640 lbs	279 lbs	1
87627	(VRF6500)	10 pad framework	165" x 30"	177" x 59"	2,640 lbs	293 lbs	1
87628	(VRF7000)	12 pad framework	174" x 30"	196" x 59"	3,168 lbs	334 lbs	1
87629	(VRF7500)	12 pad framework	207" x 30"	216" x 59"	3,168 lbs	372 lbs	1

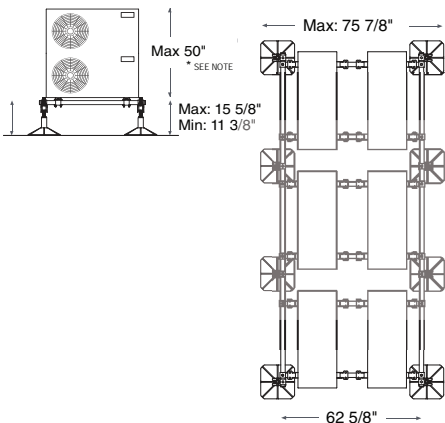



## BIG FOOT SYSTEMS® HD CUBE & HD BEAM

Heavy duty non penetrative support for chillers, AHUs, packaged plant, generators, pipes and steel.

### Heavy Duty Cube

### Specialty Frames for VRF Condensers

Code	Model	Description	Support wt. lbs	L	W	H	Ft Size	Frame wt. lbs	Qty.
87650*	(RHC-200-450)	HD Cube 200 kit 18"	2,646	44.5"	44.5"	13"	18"	137	1
87651*	(RHC-200-600)	HD Cube 200 kit 24"	4,409	51"	51"	13"	24"	159	1
87652*	(RHC-600-450)	HD Cube 600 kit 18"	2,646	44.5"	44.5"	23"	18"	165	1
87653*	(RHC-600-600)	HD Cube 600 kit 24"	4,409	51"	51"	23"	24"	181	1
87654*	(RHC-800-450)	HD Cube 800 kit 18"	2,646	44.5"	44.5"	35"	18"	177	1
87655*	(RHC-800-600)	HD Cube 800 kit 24"	4,409	51"	51"	35"	24"	192	1
87657*	(RHC-Adjuster)	Cube adjuster	4,409	9.75"	6"	-	-	6.6	1





## BIG FOOT® FAST FIX STAND RANGE

Simple, strong and sturdy ground mount support system.

# Mini-split & VRF/VRV condenser stands

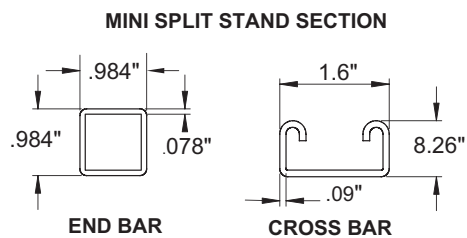
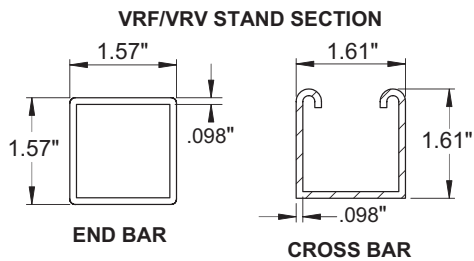

**The Fast Fix Stand Range** is a versatile ground mount support system split into two ranges, mini-splits and VRF/VRV condensing units. Available in a variety of sizes, with optional Extender Kits, the Stand Range is designed to support units both individually and in multiples. With adjustability of cross bar positions, anti-vibration mounts for mini-splits and clamp kits for the VRF/VRV units, these frames can support a wide variety of units, are cost-effective and quick to assemble. • Rugged ASTM-A36 galvanized steel corrosion resistant support. • More corrosion resistant than competitor stands. • Pre-boxed – quick assembly.

- Base extensions allow unlimited mounting possibilities.
- Compatible with all leading mini-split condensing units

Available in a variety of sizes with extender kits.

## Fast Fix Stands

### Mini-split Stand Range - 2 skus cover all mini-splits

Code	Description	Load lbs.	Wt. lbs.	Qty.
87630	B5551 Mini-split stand kit	385	49	1
87632	B5555 Riser - 4 pk.	-	3	1

Code	Description	Load lbs.	Wt. lbs.	Qty.
87631	B5554 Extender	385	42	1
87633	B5562 Riser - 2 pk.	-	2	1

**STAND RISER**

**STAND EXTENDER**



#### B5551 SYSTEM COMPONENTS

- (4) 8 in.(200mm) Footings. (2) End Bar. (2) Cross Bar
- (4) Unit Clamp/Fixing Kit.



## Fast Fix Stands

### VRF/VRV Stand Range - 6 skus cover all VRF/VRV units

Code	Description	Load lbs.	Wt. lbs.	Qty.
87634	B5556 VRF 990 stand kit	1,323	77	1
87636	B5557 VRF 1290 stand kit	1,102	84	1
87638	B5558 VRF 1450 stand kit	882	90	1

Code	Description	Load lbs.	Wt. lbs.	Qty.
87635	B5559 VRF 990E Extender	1,323	55	1
87637	B5560 VRF 1290E Extender	1,102	62	1
87639	B5561 VRF 1450E Extender	882	68	1

**VRF/VRV STAND EXTENDER**



#### 990/1290/450 SYSTEM COMPONENTS

- (4) 8 in.(200mm) Footings. (2) End Bar. (2) Cross Bar
- (4) Unit Clamp/Fixing Kit.





## BIG FOOT SYSTEMS® FRAME SUPPORTS

### Multi Foot

Frame support ideal for smaller systems

Code	Description	Qty.
87711 (RSP16)	16" Multi Foot	1
87712 (RSP24)	24" Multi Foot	2

**FEATURES**

- Strong and Lightweight
- Weather resistant PVC
- Linear track holds 1/2" hex head bolts
- Two 7/8" long bolts included

Max load capacity:  
RSP16 - 572 lbs.  
RSP24 - 1045 lbs.

87711  
H = 3 3/4"  
W = 7"  
L = 15 3/4"

87712  
H = 3 3/4"  
W = 8 3/4"  
L = 24"



### H-Frame

Accepts standard 5/8" strut, optimum support

Code	Description	Qty.
87713 (RSPD12)	H-Frame Kit w/ 12" Square	1
87714 (RSPD18)	H-Frame Kit w/ 18" Square	1
87715 (RSPD24)	H-Frame Kit w/ 24" Square	1

(each kit contains 2 feet)

**FEATURES**

- Ideal rooftop support of equipment and systems
- Weather resistant
- Recycled crumb rubber pad
- Accepts one 5/8" strut (not included)
- Build custom frames and supports

Max load capacity:  
RSPD12 - 661 lbs.  
RSPD18 - 1100 lbs.  
RSPD24 - 1100 lbs.

87713 H = 3 1/2" W = 13" L = 13"	87714 H = 4 1/4" W = 19" L = 19"	87715 H = 4 3/4" W = 25 1/4" L = 25 1/4"
---	---	---



3 kit sizes available







## POLYMER & RUBBER RISERS

### Polymer Risers

Simple lightweight raised mounting support

Code	Description	Qty.
87761 (PR-351N-I)	14" Polymer Riser	20
87762 (PR-351N-M)	18" Polymer Riser	20
87763 (PR-351N-L)	39" Polymer Riser	4
87765 (PRC-351N)	End Caps	1 Pair

#### FEATURES

- Ideal for piping, duct runs, cable trays and condensers
  - Weather resistant PVC
  - Linear track holds 3/8" hex head bolts
  - Two 7/8" long bolts included
- Max load capacity: PR-351N-I - 308 lbs.  
PR-351N-M - 397 lbs. PR-351N-L - 880 lbs.

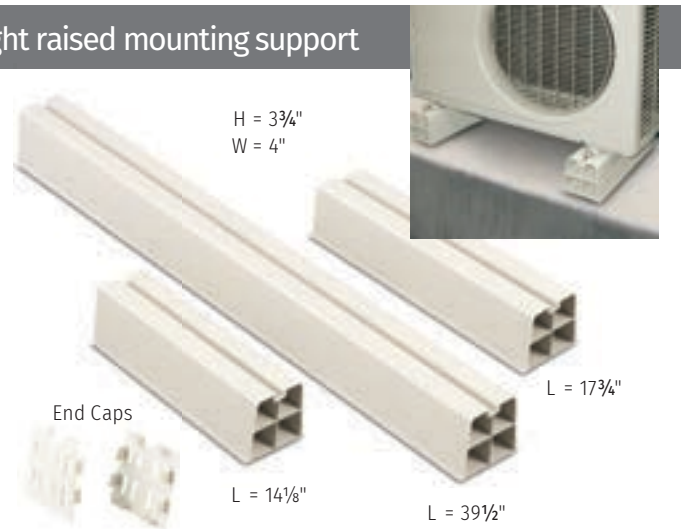

### Fix-It-Foot

Additional vibration isolation and stability

Code	Description	Qty.
87771 (RMB10)	Fix-It-Foot 10"	1
87773 (RMB16)	Fix-It-Foot 16"	1
87775 (RMB24)	Fix-It-Foot 24"	1
87776 (RMB40)	Fix-It-Foot 40"	1

#### FEATURES

- Ideal for rooftop support of equipment & systems
  - Weather resistant
  - Recycled crumb rubber pad
  - Recessed underside permits solid stance
  - Aluminum track permits the use of standard strut hardware (not included)
- Max load capacity: RMB10 - 356 lbs. RMB16 - 572 lbs.  
RMB24 - 1045 lbs. RMB40 - 1420 lbs.



### Fix-It-Foot Low

Low profile rubber riser

Code	Description	Qty.
87772 (RMB10L)	Fix-It-Foot Low 10"	1
87774 (RMB16L)	Fix-It-Foot Low 16"	1

#### FEATURES

- Ideal for rooftop support of equipment & systems
  - Weather resistant
  - Recycled crumb rubber pad
  - Recessed underside permits stability
  - Aluminum track permits the use of standard strut hardware (not included)
- Max load capacity: RMB10L - 356 lbs. RMB16L - 572 lbs.

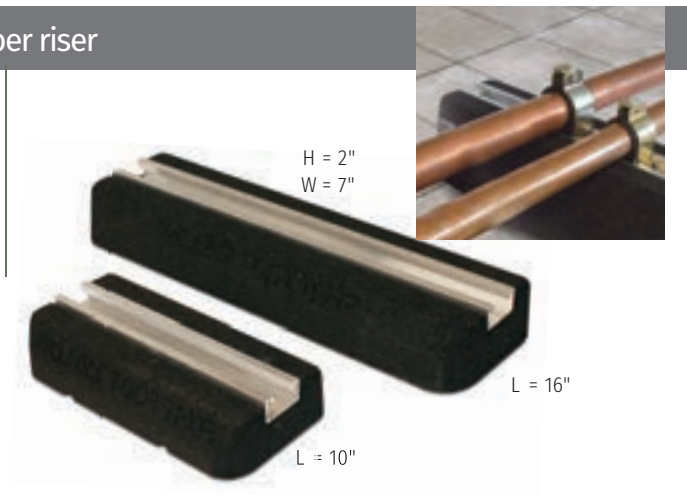



## UNIVERSAL BRACKETS

### Wall Bracket

Sliding cross bar provides exceptional width range

Code	Description	Qty.
87733 (WBB300)	Wall Bracket - powdercoat	1
87734 (WBB300SS)	Wall Bracket - stainless steel	1
87735 (WBB500)	Wall Bracket - powdercoat	1

#### FEATURES

- Strong secure support
  - Stainless steel or powdercoat finish
  - Includes level for convenience
- Min/Max mounting width: 9¾" - 31"  
 Min/Max mounting depth: 10½½" - 16"  
 Max load capacity: WBB300 - 300 lbs.  
 WBB300SS - 300 lbs. WBB500 - 500 lbs.



Shown in Stainless

### Wall Bracket

Extra integral cross bracing provides ultimate stability

Code	Description	Qty.
87732 (PCKJ30)	Wall Bracket	1

#### FEATURES

- Extra stability
  - Galvanized finish
- Min/Max mounting width: 15¾" - 35¼"  
 Min/Max mounting depth: 9¾" - 15"  
 Max load capacity: 330 lbs.

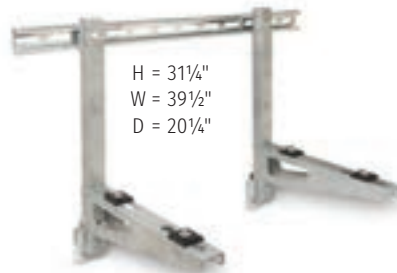

### Wall Bracket

Hurricane rated wind resistant support

Code	Description	Qty.
87740 (WBB500HR)	Wall Bracket	1

#### FEATURES

- Ultimate stability
  - Galvanized finish
  - State of Florida approved - FL18362
- Min/Max mounting width: 9¾" - 31"  
 Min/Max mounting depth: 10½" - 16"  
 Max load capacity: 500 lbs.



**Miami-Dade County, Florida**  
 NOA No. 15-0820.06, Expiration  
 date 10/6/21

### Under Window Bracket

Ideal for in window mounted A/C support

Code	Description	Qty.
87731 (CBZG)	Under Window Bracket	1

#### FEATURES

- Strong secure support • Galvanized finish
- Min/Max mounting width: 11¾" - 27½"  
 Min/Max mounting depth: 6¼" - 13"  
 Max load capacity: 176 lbs.



H = 11¼"  
 W = 29½"  
 D = 16¾"

## Slab Stand

Raises equipment up above flat surface

Code	Description	Qty.
87743 (CNG)	Slab Stand - powdercoat	1
87746 (PCNG63)	Slab Stand - galvanized	1

### FEATURES

- Anti-slip rubber feet
- Galvanized or powdercoat finish

Min/Max mounting width:

87743 - 11<sup>3</sup>/<sub>4</sub>" - 27<sup>1</sup>/<sub>2</sub>" 87746 - 15<sup>3</sup>/<sub>4</sub>" - 39<sup>3</sup>/<sub>4</sub>"

Min/Max mounting depth:

87743 - 6<sup>1</sup>/<sub>4</sub>" - 13<sup>1</sup>/<sub>4</sub>" 87746 - 11<sup>3</sup>/<sub>4</sub>" - 17"

Max weight capacity:

87743 - 176 lbs. 87746 - 440 lbs.

Individually adjustable legs for uneven surfaces



## Slope Stand

Provides level mounting surface on sloped roofs

Code	Description	Qty.
87745 (WRB250)	Wall Bracket	1

### FEATURES

- Levels slopes up to 45° or 12" pitch
- Powdercoat finish

Min/Max mounting width: 6" - 35"

Min/Max mounting depth: 10" - 19"

Max load capacity: 250 lbs.

Includes level



## Duplex Stand

Securely mounts two condenser units

Code	Description	Qty.
87744 (CWGL)	Duplex Stand	1

### FEATURES

- Sturdy support
- Powdercoat finish
- Anti-slip rubber feet

Min/Max mounting width: CWGL - 15<sup>3</sup>/<sub>4</sub>" - 31<sup>1</sup>/<sub>2</sub>"

Min/Max mounting depth: CWGL - 7<sup>7</sup>/<sub>8</sub>" - 15"

Max load capacity: CWGL - 176 x 2 lbs.



87744  
H = 36<sup>1</sup>/<sub>4</sub>"  
W = 17"  
D = 36"



## DUCTLESS A/C INSTALLATION ACCESSORIES

### RectorSeal® NoKink™

#### Flexible mini-split refrigerant line connector

Code	Description	Qty.
66731	1/4" x 3' flex hose	4
66733	3/8" x 3' flex hose	4
66737	1/2" x 3' flex hose	4
66735	5/8" x 3' flex hose	4
66732	3/4" x 3' flex hose	4
66734	7/8" x 3' flex hose	4
68231	1/4" x 6' flex hose	4
68233	3/8" x 6' flex hose	4
68235	5/8" x 6' flex hose	4
68237	1/2" x 6' flex hose	4



#### FEATURES

- Eliminates kinking of refrigerant line
- Stainless steel internal piping and jacketing
- 3" copper stubs allow for easy flaring and quick connections

**APPLICATION** • Corrugated 300 series stainless steel flexible piping, protected with woven stainless steel jacketing, connects evaporator units to linesets quickly and easily • Eliminate kinks and refrigerant leaks • Allows for ease of future maintenance • UL listed for R410A

**Specifications**  
 36" and 72" overall length  
 3" copper stub length  
 10 sizes available

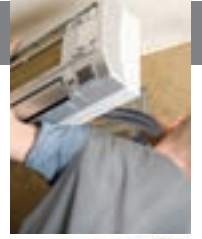

### RectorSeal® Paircoil

#### Pre-insulated and paired linesets

Code	Description	Qty.
87781	1/4" liquid line w/ 3/8" insulation & 3/8" suction line w/ 3/8" insulation	1
87782	1/4" liquid line w/ 3/8" insulation & 1/2" suction line w/ 3/8" insulation	1

#### FEATURES

- 50' rolls can be freely cut
- Tough, coated insulation will not tear
- Length markings every 2 feet for accurate cutting
- Meets ASTM B280 standard

**APPLICATION** • For air conditioning & refrigeration installations using R410A, R22, etc. • Saves time and labor on mini-split installs & retrofits

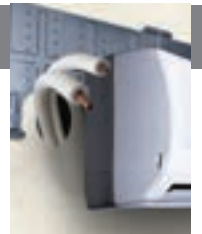

# Mighty Bracket™

## Mini-split installation support tool

Code	Description	Qty.
97705	Mini-split support tool	4

### FEATURES

- Allows single person installation
- Simple clip on support
- Does not damage walls.
- Use on most brands of mini-splits
- Folds for easy storage
- Includes tote bag

US Patent No. 9,772,113



**APPLICATION** • Hook onto mini-split mounting plate to hold mini-split unit securely in place while installing refrigerant lines, condensate line and electrical hookup.

**USER INSTRUCTIONS** 1. Attach Mounting Hooks of Mighty Bracket to the mini-split mounting plate tabs. (If no tabs are present on the mounting plate, Mighty Bracket hooks can be attached by screws threaded into the wall stud.) 2. Place Foot Supports flat against the wall. (If necessary to avoid potential wall scratching, place clean towel or cardboard between support foot and wall surface) 3. Position Level Adjustment Pins to make Support Arm of the brackets horizontal. 4. Position lift Gates at the end of Support Arms to make sure the unit cannot slide off. 5. Place protective Sleeve Socks over Gates to avoid scratching the unit. 6. Set unit securely onto the top of the Support Arms. 7. Connect refrigerant lines using RectorSeal® NoKink™.\* 8. Connect condensate drain piping and electrical wiring. 9. Carefully lift and place the indoor unit onto top tabs of mounting plate. 10. While ensuring unit does not fall, carefully remove Mighty Bracket and installation is complete.

\* When paired with RectorSeal® NoKink™ Mighty Bracket™ allows simple installation without damaging or kinking copper refrigerant lines.

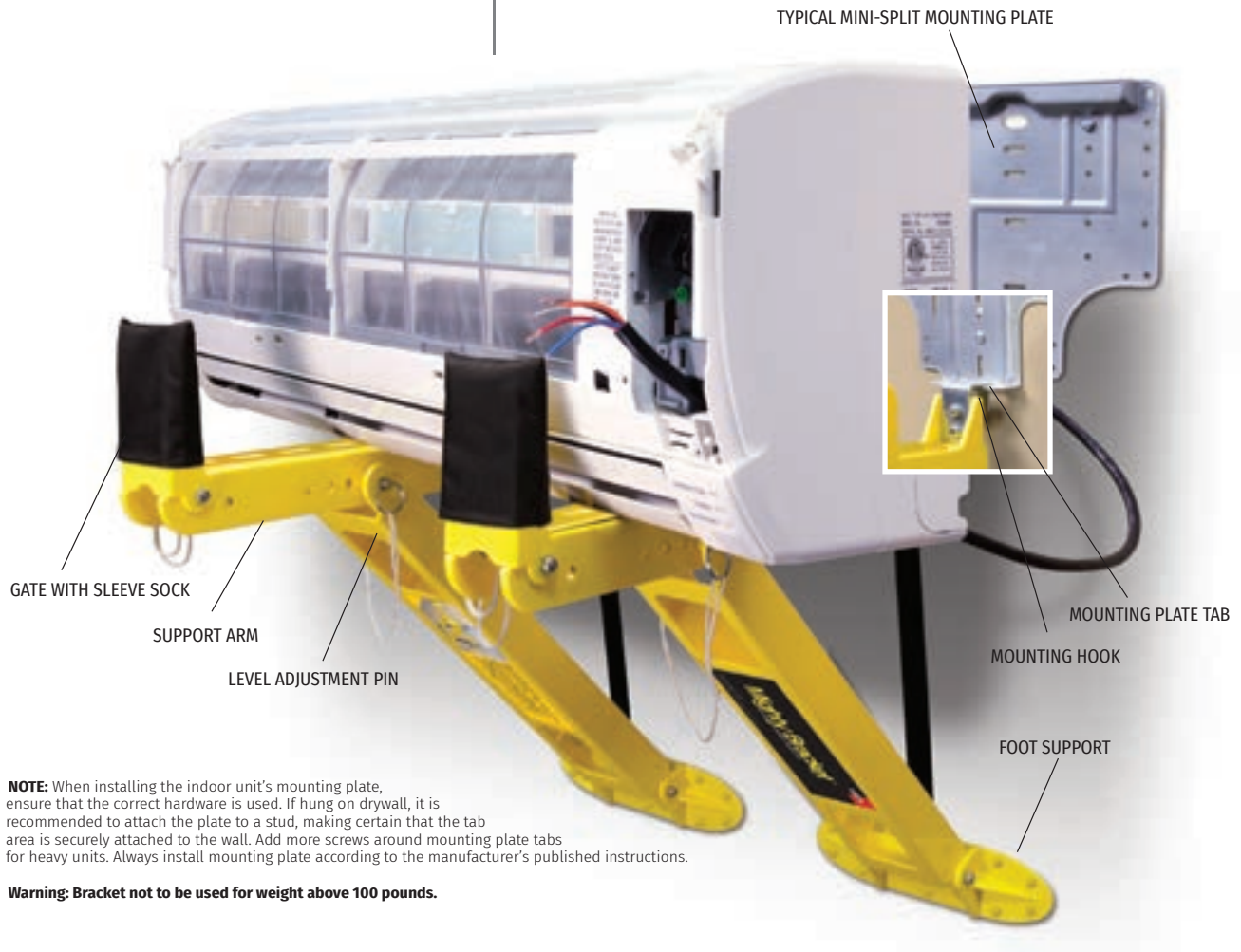

**NOTE:** When installing the indoor unit's mounting plate, ensure that the correct hardware is used. If hung on drywall, it is recommended to attach the plate to a stud, making certain that the tab area is securely attached to the wall. Add more screws around mounting plate tabs for heavy units. Always install mounting plate according to the manufacturer's published instructions.

**Warning:** Bracket not to be used for weight above 100 pounds.

# Aspen® Xtra

**FEATURES**

Keep a ready stock of accessories on-hand with our Xtra Tool Box,

- Connectors
- Adapters
- Check valves

Ductless A/C installation accessory tool box.

ACCESSORY TOOL BOX			
Code	Model	Description	Qty.
83999	AX00051/R	12 section fitting and accessory box (18"x14"x3")	1

ACCESSORY TOOL BOX CONTENTS LISTING			
Code	Model	Description	Qty.

*Mini Pump Rubber Adapter/Connector*

83970	FP2001	5/8" mini pump to 3/4" ducted drain (16mm-20mm)	2
83971	FP2002	5/8" mini pump to 1" ducted drain (16mm-25mm)	2
83972	FP2003	5/8" mini pump to 1-1/4" ducted drain (16mm-32mm)	2

*Mini Pump 90° Long Arm Bend Connector*

83973	FP2006	1/2" to 5/8" (12mm-16mm) long arm	2
-------	--------	-----------------------------------	---

*Pipe to Pipe Rubber Connector/Adapter*

83977	FP2042	3/4" PVC to 5/8" (20mm-16mm)	2
83978	FP2044	3/4" PVC to 1" (20mm-25mm)	2
83979	FP2046	3/4" PVC to 1-1/4" (20mm-32mm)	2

*Hose to Hose Connectors*

83984	FP2024	1/4" "T" connectors (6mm)	3
83985	FP2028	1/4" elbow connectors (6mm)	4
83986	FP2622	1/4" straight connectors (6mm)	3
83987	FP2030	3/8" "T" connectors (10mm)	3
83988	FP2032	3/8" elbow connectors (10mm)	3
83989	FP2624	3/8" straight connectors (10mm)	3

*Tube Adapter/Fitting*

83990	FP2038	3/8" or 1/4" (10mm/6mm) self sealing soil pipe connector	2
-------	--------	--	---

*Check Valves*

83982	FP2628	1/4" Non Return Valves (6mm)	2
83983	FP2630	3/8" Non Return Valves (10mm)	2





Code	Model	Description	Units/Bag	Bags/Carton
------	-------	-------------	-----------	-------------



**Rubber adapter**  
Connects a ducted unit to a Mini Pump Reservoir.

83970	FP2001	5/8" mini pump to 3/4" ducted drain (16mm-19mm)	3	10
83971	FP2002	5/8" mini pump to 1" ducted drain (16mm-25mm)	3	10
83972	FP2003	5/8" mini pump to 1-1/4" ducted drain (16mm-32mm)	3	10



**90° Long Arm Bend**  
Connects a Wall Mount to Mini Pump Reservoir.

83973	FP2006	1/2" to 5/8" (12mm-16mm) long arm	3	10
-------	--------	-----------------------------------	---	----



**Rubber Adapter**  
Connects a Cassette Unit Condensate Drain Pipe to a Tank Pump.

83974	FP2011	5/8" cassette unit outlet to 3/4" hose (16mm-19mm)	3	10
83975	FP2012	1" cassette unit outlet to 3/4" hose (25mm-19mm)	3	10
83976	FP2013	1-1/4" cassette unit outlet to 3/4" hose (32mm-19mm)	3	10

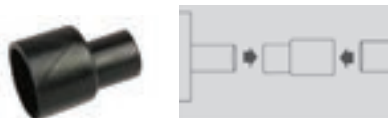

**Pipe to Pipe Rubber Connector/Adapter**  
Connect 3/4" PVC Overflow Pipe to Waste Pipe.

83977	FP2042	3/4" PVC to 5/8" (19mm-16mm)	3	10
83978	FP2044	3/4" PVC to 1" (19mm-25mm)	3	10
83979	FP2046	3/4" PVC to 1-1/4" (19mm-32mm)	3	10



**Tube Connector Fitting and Straight Reducer**  
In-line junction for mismatched tubing.

83980	FP2020	3/8" to 1/4" straight reducer (10mm to 6mm)	5	10
83981	FP2632	5/8" to 1/4" reducing connector (16mm-6mm)	5	10



**Hose to Hose Connector**  
In-line junction for matched size tubing.

83984	FP2024	1/4" "T" connectors (6mm)	5	10
83985	FP2028	1/4" elbow connectors (6mm)	5	10
83986	FP2622	1/4" straight connectors (6mm)	5	10
83987	FP2030	3/8" "T" connectors (10mm)	5	10
83988	FP2032	3/8" elbow connectors (10mm)	5	10
83989	FP2624	3/8" straight connectors (10mm)	5	10



**Mini Pump Pre-Filter**  
Protects mini pump from condensate debris.

83893	FP2040	5/8" Pre-filter for Aspen Mini Pumps	3	10
-------	--------	--------------------------------------	---	----

# ASPEN *Xtra* ACCESSORIES

Code	Model	Description	Units/Bag	Bags/Carton
------	-------	-------------	-----------	-------------



### Check Valve Connector/Fitting - Prevents back-flow of condensate.

83982	FP2628	1/4" Non Return Valves (6mm)	Qty 5	Qty 10
83983	FP2630	3/8" Non Return Valves (10mm)	Qty 5	Qty 10

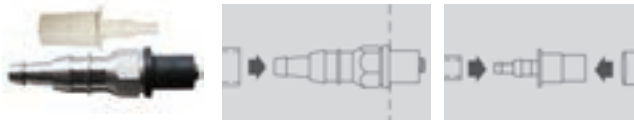

### Tube Adapter - Connects discharge condensate to waste/soil pipe

83991	FP2040	3/4" to 3/8" or 1/4" (20mm-10mm or 6mm)	Qty 3	Qty 10
83990	FP2038	3/8" or 1/4" self sealing soil pipe connector (10mm/6mm)	Qty 3	Qty 10

# ASPEN *Xtra* PIPE SUPPORTS

All pipe supports are multi-packed in transparent Point-of-Purchase ready poly bags.



Code	Model	Description	Units/Bag	Bags/Carton
------	-------	-------------	-----------	-------------



### Pipe Ties - Wide & Rugged. Perfect for multiple insulated linesets.

83998	B6414	T400 white 15-3/4" long by 3/4" wide	Qty 10	Qty 10
-------	-------	--------------------------------------	--------	--------



### Metal Pipe Hanger - Designed for supporting lineset pairs.

83992	B6492	Fits 3/8" liquid & 5/8" gas pipes (incl. insulation)	Qty 10	Qty 10
83993	B6494	Fits 5/8" liquid & 1-1/8" gas pipes (incl. insulation)	Qty 10	Qty 10



### Grip Locks - Versatile. Mounts to any surface. Ideal for insulated linesets.

83996	B6188	Fits 1/2" liquid & 7/8" gas pipe (incl. insulation)	Qty 10	Qty 10
83997	B6189	Fits 5/8" liquid & 1-1/8" gas pipe (incl. insulation)	Qty 10	Qty 10

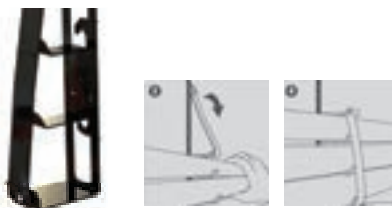

### Three Pipe Clip - Supports VRV / VRF systems insulated linesets.

83994	B6362	For pipe groups 1/2", 3/4", 1-1/8", to 5/8", 1", 1-1/8"	Qty 5	Qty 10
83995	B6364	For pipe groups 7/8", 1-1/8", 1-3/8" to 3/4", 1-3/8", 1-5/8"	Qty 5	Qty 10



# Pipe Joining

Rectorseal® Thread Sealants

Rectorseal® Solvent Cements

Nokorode® Soldering Flux



## RECTORSEAL® THREAD SEALANTS

The finest thread sealants in the industry formulated by our highly-skilled chemists

### RectorSeal® No. 5®

Multi-purpose pipe thread sealant

Code	Description	Qty.
25790	1-¾ oz.	24
25631	¼ pt.	24
25551	½ pt.	24
25431	1 pt.	12
25300	1 qt.	12
25271	1 gal.	4
25191	5 gal.	1
25112	55 gal.	1



FILE NO. 1282



LISTED  
PIPE JOINT  
COMPOUND  
MH12259

- FEATURES**
- Soft set / Slow drying
  - Lead free
  - Smooth application
  - 2 year shelf life
  - Certified to NSF/ANSI 61-G & 372

**APPLICATION** • Lubricates and protects threaded pipe and fittings  
 • Can be pressurized immediately up to 100 psi for piping up to 2" diameter • Ideal for a wide variety of fluids and gases including potable water

Recommended for • Galvanized Steel • Iron • Brass  
 • Copper • Aluminum • Stainless Steel • Polyethylene  
 • RTRP • PVC



Also available in 55 gal. container

### No. 5® Sub-Zero

Low temperature, low odor pipe thread sealant

Code	Description	Qty.
27731	¼ pt.	24
27651	½ pt.	24
27541	1 pt.	12
27460	1 qt.	12
27371	1 gal.	4
27111	5 gal.	1



FILE NO. 1282

- FEATURES**
- Low temperature application -35°F
  - All weather formula
  - Lead free
  - 2 year shelf life

**APPLICATION** • Odorless, non-staining, low temperature application • Brushable to -35°F • Can be pressurized immediately  
 Recommended for • Galvanized Steel • Iron • Brass • Copper  
 • Aluminum • Stainless Steel • Polyethylene • RTRP • PVC



See ordering chart for container sizes available.

## RectorSeal® T plus 2®

### PTFE enriched pipe thread sealant

Code	Description	Qty.
23710	1-3/4 oz.	24
23631	1/4 pt.	24
23551	1/2 pt.	24
23431	1 pt.	12
23391	1 qt.	12
23271	1 gal.	4
23191	5 gal.	1
23112	55 gal.	1



FILE NO. 1282



- FEATURES**
- Non-setting
  - Lead free
  - 2 year shelf life
  - Certified to NSF/ANSI 61-G & 372

- APPLICATION** • Contains PTFE and synthetic fibers for superior performance
- Can be pressurized immediately following application
- Recommended for
- Galvanized Steel
  - Iron • Brass • Copper
  - Aluminum
  - Stainless Steel
  - Polyethylene • RTRP
  - PVC • CPVC • ABS



Also available in 55 gal. container

## RectorSeal® Tru-Blu™

### Vibration resistant pipe thread sealant

Code	Description	Qty.
31780	1-3/4 oz.	24
31631	1/4 pt.	24
31551	1/2 pt.	24
31431	1 pt.	12
31300	1 qt.	12



FILE NO. 1282

- FEATURES**
- Fast drying / Flexible set
  - Contains PTFE
  - Lead free
  - 2 year shelf life
  - Certified to NSF/ANSI 61-G & 372

- APPLICATION** • For high vibration environments such as refrigeration and industrial applications
- Designed for sealing vibration prone NPT connections
- Recommended for
- Galvanized Steel • Iron • Brass
  - Copper • Aluminum • Stainless Steel
  - PVC • Polyethylene
  - Reinforced fiberglass



## RectorSeal® No. 7

### Corrosive chemical pipe thread sealant

Code	Description	Qty.
17432	1 pt.	4

- FEATURES**
- Soft Set
  - Lead free
  - 2 year shelf life
  - Complies with AMS-S-7916 & TT-S-1732

- APPLICATION** • Slow drying sealant for use with lines carrying corrosive chemicals: diluted acids, caustics and other chemical solutions
- Recommended for
- Galvanized Steel • Iron
  - Brass • Copper • Aluminum • Stainless Steel



\*FBC™ System Compatible™ indicates that this product has been tested, and is monitored on an ongoing basis, to assure its chemical compatibility with FlowGuard Gold®, BlazeMaster® and Corzan® pipe and fittings.

\*\*FBC™, FlowGuard Gold®, BlazeMaster® and Corzan® are licensed trademarks of The Lubrizol Corporation.



## RECTORSEAL® SOLVENT CEMENTS

### Jim™ PR-1L

○ Purple - Low-VOC hi-etch primer

Code	Description	Qty.
55910	¼ pt.	24
55912	½ pt.	24
55914	1 pt.	12
55918	1 qt.	12
55920	1 gal.	4



pw-G-dwv



FILE NO. 4585

#### FEATURES

- Fast acting
- Superior bonding
- LEED compliant
- 2 year shelf life
- Low-VOC
- Meets ASTM F656 specs

**APPLICATION** • Prepares surfaces for superior bonding strength • For use on PVC and CPVC pipe, tubing and socket-type fittings in both schedule 40 and schedule 80

Recommended for

- Potable water
- Pressure pipe • Gas
- Conduit • Sewers
- DWV systems



### Gene™ 404L

○ Clear - regular body PVC solvent cement

Code	Description	Qty.
55901	¼ pt.	24
55902	½ pt.	24
55904	1 pt.	12
55906	1 qt.	12
55908	1 gal.	4



pw-G-dwv-sw



FILE NO. 1796

#### FEATURES

- Fast setting formula
- LEED compliant
- NSF approved for potable water
- 2 year shelf life
- Exceeds ASTM D2564 specs

**APPLICATION** • Polyvinyl chloride (PVC) solvent cement used for joining PVC pipe and socket-type fittings which meet Class 12454 as

defined in ASTM specification

D1784 • ABS to PVC

non-pressured transition

joints • Schedule 40 up

to 2" pressure; up to

4" non-pressure pipe (DWV)

Recommended for

- Potable water
- Pressure pipe • Gas
- Conduit • Sewers
- DWV systems



## Hot™ 203L

● Blue - medium body PVC solvent cement

Code	Description	Qty.
55988	¼ pt.	24
55989	½ pt.	24
55990	1 pt.	12
55993	1 qt.	12
55994	1 gal.	4



pw-G-dwv-sw



FILE NO. 1796

### FEATURES

- Fast drying
- Excellent in cold weather
- LEED compliant
- 2 year shelf life
- Meets ASTM D2564 specs

**APPLICATION** • Polyvinyl chloride (PVC) solvent cement joins both rigid and flexible PVC pipe and socket-type fittings which meet Class 12454 as defined in ASTM specifications D1784 • For all rigid PVC classes up to 6" schedule 40 and 1-¼" schedule 80

Recommended for

- Irrigation • Pools • Spas
- Potable water • Pressure pipe
- Gas • Conduit • Sewers
- DWV systems
- Flexible PVC hose



## Arctic™ 616L

○ Clear - medium body PVC solvent cement

Code	Description	Qty.
55919	1 pt.	12
55948	1 qt.	12
55953	1 gal.	4



pw-G-dwv-sw



FILE NO. 1796

### FEATURES

- Formulated for use in cold weather
- LEED compliant
- NSF approved for potable water
- 2 year shelf life
- Exceeds ASTM D2564 specs

**APPLICATION** • Premium polyvinyl chloride (PVC) solvent cement used for joining PVC pipe and socket-type fittings which meet Class 12454 as defined in ASTM specification D1784

• Pipe up to 6" schedule 40; 1-¼" schedule 80

• Remains stable from 0°F to 120°F

Recommended for

- Potable water
- Pressure pipe
- Gas • Conduit
- Sewers
- DWV systems





## RECTORSEAL® SOLDERING

### Nokorode® Regular

Code	Description	Qty.
14000	1.7 oz.	48
14010	4 oz.	24
14020	8 oz. tool box	24
14030	1 lb.	12



#### FEATURES

- Lead Free
- Cleans & fluxes all at one time
- Safe for potable water systems
- Certified to NSF/ANSI 61-G & 372
- Meets O-F-506 Type 1A & A-A-51145, MIL-F-4995-2 specs

### Multi-purpose paste flux

**APPLICATION** • All purpose, soft soldering paste flux with a special oil base that protects the solder against corrosive attack

- Non-aggressive formula. Ideal for copper and brass fittings

Recommended for

- All solder alloys including 95/5 and lead free



### Rectorshield™

Code	Description	Qty.
83554	11 oz. tube	24

#### FEATURES

- Biodegradable
- Odorless

### Heat absorption paste

**APPLICATION** • A heat absorption paste to help prevent damage to sensitive controls, valves, plastic faucet parts, equipment and other soldered connections

- Reduces heat transfer by absorbing thermal energy from heat and flames

Recommended for

- Copper
- Other types of metal pipe



### Open Mesh Sandcloth

Code	Description	Qty.
61760	5 yd.	50
61759	10 yd.	50
61758	25 yd.	20

#### FEATURES

- Reuseable
- 100% waterproof
- Tear-resistant nylon backing

### Reuseable waterproof abrasion

**APPLICATION** • A premium abrasive, waterproof material with top quality performance

- If the material becomes loaded with fillings, simply rinse in water and tap out.

Recommended for

- Copper



# Firestopping & Sealants

Metacaulk® Intumescent Sealants

Metacaulk® Elastomeric Sealants

RectorSeal® Silicone Sealants



## METACAULK® FIRESTOPPING SOLUTIONS

Full line of sealants meet all firestopping applications

### Metacaulk® 1000

Intumescent, water-based firestop sealant

Code	Description	Qty.
66640	10.3 oz. cartridge	12
66303	30 oz. cartridge	12
66312	20.2 oz. sausage pack	12
66305	1 gal. pail	4
66307	2 gal. pail	1
66309	5 gal. pail	1

**APPLICATION** • Will prevent the spread of fire through joint openings and through-penetrations • No dilution or mixing required  
 • Can be used in areas with some movement • Use in fire-rated gypsum wallboard partitions, concrete walls or floors, wood floors and concrete or corrugated steel deck floor/ceiling assemblies  
 Recommended for • Metal • Insulated pipes  
 • Fiberglass & plastic pipes • Wall construction joints  
 • Power & telephone cables



#### FEATURES

- UL Classified systems up to 4 hrs
- Highly intumescent
- Excellent freeze-thaw
- For interior use - paintable
- VOC compliant
- STC rating 62
- Meets ASTM E 814, UL 1479 & UL 2079 standards

See ordering chart for container sizes available



FBC® "System Compatible" indicates that this product has been tested, and is monitored on an ongoing basis, to assure its chemical compatibility with FlowGuard Gold®, BlazeMaster® and Corzan® pipe and fittings.

FBC®, FlowGuard Gold®, BlazeMaster® and Corzan® are licensed trademarks of The Lubrizol Corporation.



## Metacaulk® MC 150+

### General purpose firestop sealant

Code	Description	Qty.
66648	10.3 oz. cartridge	12
66383	30 oz. cartridge	12
66385	20.2 oz. sausage pack	12
66389	5 gal. pail	1



#### FEATURES

- Water-based - VOC compliant
- STC rating 51
- Freeze-thaw
- Use for most common applications

**APPLICATION** • One component, general purpose fire-rated sealant and smoke seal for construction joints and through-penetrations on both horizontal and vertical surfaces

- Non-sag caulking grade sealant that is easy to apply as well as to retrofit
- Suitable for dynamic movement
- Recommended for
  - Metal
  - Insulated pipes
  - Fiberglass and plastic pipes
  - Wall construction joints
  - Power and telephone cables



## Metacaulk® 350i

### Elastomeric seal firestop sealant

Code	Description	Qty.
66616	10.3 oz. cartridge	12
66611	20.2 oz. sausage pack	12
66613	5 gal.	1



#### FEATURES

- Sound rated
- Excellent freeze-thaw
- STC rating 53

**APPLICATION** • One component, general purpose sealant and smoke seal

- Intumescent, water-based, non-sag caulking grade sealant that is easy to apply and great for retrofits
- Suitable for dynamic movement
- Recommended for
  - Metal
  - Insulated
  - Fiberglass & plastic pipes
  - Wall construction joints
  - Power & telephone cables



## Metacaulk® 835+

### Elastomeric, silicone firestop sealant

Code	Description	Qty.
66645	10.15 oz. cartridge	12
66019	5 gal. pail	1
66300	20.2 oz. sausage pack caulk grade	12
66301	20.2 oz. sausage pack self leveling	12



#### FEATURES

- Exterior / Interior use
- Water resistant
- STC rating 55

**APPLICATION** • Used in areas under constant vibration or movement • Resistant to chemical exposure  
Recommended for • PVC pipe on closed (pressure) systems  
• EMT • Insulated and uninsulated steel pipe • Construction and control joints • Interior expansion joints



*Also available in Sausage pack and 5 gal. pail*



## RECTORSEAL® CAULKS & SEALANTS

### RectorSeal® RS 136

#### Fireblock / smoke seal caulk

Code	Description	Qty.
66408	10.3 oz. cartridge	12



#### FEATURES

- Easy application
- Interior applications only
- Water clean-up

- APPLICATION** • General purpose, residential acoustical fireblock  
 Recommended for • Electrical • Plumbing • Plastic pipe  
 • Telephone communication systems penetrations



### RectorSeal® Silicone Sealant

#### General purpose

Code	Description	Qty.
57505	10.3 oz. tube - white	12
57506	10.3 oz. tube - clear	12

#### FEATURES

- Remains flexible
- Vibration resistant
- Indoor/outdoor

- APPLICATION** • Ideal for general sealing • Dries to touch in 30 minutes and fully cures in 24 hours  
 Recommended for • Around electrical panels • Windows • Doors • Pipes/vents  
 • Corner joints • Aluminum siding  
 • Other interior/exterior building materials



### RectorSeal® Hi-Temp™

#### 100% RTV silicone caulk

Code	Description	Qty.
57500	10.1 oz. cartridge	24

#### FEATURES

- One component
- USDA specs for use in federally inspected meat and poultry plants
- F.D.A. reg #21 CFR 177.2600
- TT-S-001543A (COM-NBS) Class A
- TT-S00230C (COM-NBS) Class AA
- MIL-A-46106B Amend 3, Type 1
- Canadian 19-GP-9MA, Type 1

- APPLICATION** • Cures to a strong durable resilient rubber. Service Temperature -85 to +500 F. Vibration resistant.  
 Recommended for • Glass • Clean metal  
 • Most types of non-oily wood  
 • Vulcanized silicone rubber • Silicone resins  
 • Natural and synthetic fiber • Ceramic  
 • Paper • Many painted and plastic surfaces



# A/C Chemicals

Coil Cleaners

Leak Locators

Cleaners & Treatments

Evaporative Cooler Treatments

Cooling Tower Treatments



## COIL CLEANERS

### K.O. Dirt Blaster™

Dirt and grease stripper

Code	Description	Qty.
88438	20 oz. aerosol	12

#### FEATURES

- Dissolves grease quickly
- Quick drying
- Pressure washes small condenser coils without a water rinse
- Non-flammable
- No CFC's



#### APPLICATION

- Quickly dissolves grease
  - Non-conductive so will not short out electrical equipment
  - Effective on restaurant grease and other greasy surfaces
- Recommended for
- Refrigeration coils • Oil burner surfaces
  - Machine parts • Switches
  - Relays • Circuit breakers • Motors
  - Electrical components

### Clean-N-Safe™

Condenser & evaporator coil cleaner

Code	Description	Qty.
83780	20 oz. aerosol	12

#### FEATURES

- Deep cleaning foam
- Non-acid
- Reduces energy cost
- Environmentally friendly
- Biodegradable



#### APPLICATION

- Effectively cleans and removes soils
  - Foam powers off dirt and build-up without chemically attacking (corrode) coils, surrounding metal, other HVAC equipment components or adjacent roofing materials
- Recommended for
- Air conditioning • Refrigeration
  - Heat pump coils

## Renewz™

### Foaming non-acid coil cleaner

Code	Description	Qty.
82644	1 gal.	4
82646	5 gal.	1
82650	55 gal.	1

#### FEATURES

- High foaming
- Brightener

**APPLICATION** • Leaves aluminum bright, shiny and clean in less than 5 minutes

- Loosens material in hard-to-reach places

Recommended for

- Air-cooled condenser coils • Aluminum
- Cooking grease • Electronic air filters



## Coil-Rite™

### Evaporator coil cleaner

Code	Description	Qty.
82612	1 gal.	4
82614	5 gal.	1
82618	55 gal.	1

#### FEATURES

- Non-acid
- Non-flammable

**APPLICATION** • Self-rinsing cleaner and degreaser • Lifts grime and oil from normally inaccessible places

Recommended for

- Evaporator coils • Air conditioning and air handling equipment • Electronic & permanent air filters



## Foam-A-Coil™

### Foaming condenser & evaporator coil cleaner

Code	Description	Qty.
82632	1 gal.	4
82634	5 gal.	1
82638	55 gal.	1
82640	12 oz. aerosol	12

#### FEATURES

- Non-acid
- Non-flammable

**APPLICATION** • Foaming biodegradable cleaner and degreaser • Lifts grime and oil from normally inaccessible places

Recommended for

- Evaporator and condenser coils
- Air conditioning and air handling equipment
- Electronic & permanent air filters



## COIL CLEANERS

Continued

### Desolv™

#### Mini-split Evaporator Coil and Blower Fan Cleaner.

Code	Description	Qty.
82565	Desolv Solution (1 gallon)	6
82561	Desolv Aerosol (16 oz.)	12

#### FEATURES

- Safe to Use
- Concentrated
- Will Not Corrode Parts
- Completely Biodegradable



**APPLICATION** • Powers off dirt and build up from air conditioning, refrigeration and heat pump coils safely and effectively. • Reduces energy cost by increasing the efficiency of the A/C system.



Straw in up position:  
Normal spray force.  
Straw in down position:  
Strong spray force.

### Desolv™ Cleaning Kit

#### Mini-split Evaporator Coil Cleaning Kit

Code	Description	Qty.
82560	Desolv Kit with 2 Single Use Funnel Bags	1
82562	Desolv Single Use Funnel Bags	10

#### KIT CONTENTS

- Desolv Cleaning Solution (1 gal.)
- C-Band Frame Assembly
- Single Use Funnel Bags (2)
- Drain Pail (5 gal)
- Installation Instructions

**APPLICATION** • Use to deep clean the indoor evaporator of mini-split A/C units that are located in areas where wall and floor protection are necessary. Kit is reusable. • Desolv Solution and Funnel Bags are also sold separately.



The funnel bags are for single use only.

Product Licensed Under  
U.S. Patent #6863116



## CLEANERS & TREATMENTS

### Ice Machine Cleaner

#### Food Grade & Nickel-Safe

Code	Description	Qty.
88312	16 oz.	12
88314	1 gal.	4

#### FEATURES

- Assures clean, fresh-tasting ice
- Safe for nickel-plated surfaces
- Meets Manitowoc Spec GES-6

**APPLICATION** • Removes scale, muck and slime which can cause bad taste and foul odors

- Food-grade acid cleaner opens constricted water lines

Recommended for

- Metal & plastic surfaces



### Liquid Descalit™

#### Scale Remover

Code	Description	Qty.
80902	1 gal.	4

#### FEATURES

- Anti-foaming
- Color changing strength indicator

**APPLICATION** • An economical scale and lime dissolver with patented corrosion inhibitors

Recommended for

- Heavily-scaled equipment
- Cooling towers • Condensers
- Water heaters



## COOLING TOWER & EVAPORATIVE COOLER TREATMENTS

### CTT™-Tablets

#### Feeder tablets

Code	Description	Qty.
68036	300 tablet pail	1

#### FEATURES

- 100% active, non-acidic
- Controls foaming
- For systems up to 400 tons

**APPLICATION** • Prevents hard water mineral scale formation and both ferrous and non-ferrous corrosion

- Suspends mud, dirt and silt which can clog condenser tubes and spray nozzles

Recommended for

- Works in many popular feeders



### Refresh™ Tablets

#### Evaporative Cooler Treatments

Code	Description	Qty.
68114	4 tablet tube	12
68112	275 tablet pail	1

#### FEATURES

- Self-metering
- Reduces break-downs
- EPA Reg. no. 51219-7

**APPLICATION** • Eliminates growths and odors in evaporative coolers, humidifiers & air conditioners

- Improves efficiency and reduces costs

Recommended for

- Reservoirs • Drain pans





## LEAK LOCATORS

Detect gas leaks in pipes or tank systems.

### Better Bubble™

#### Gas leak locator

Code	Description	Qty.
65554	8 oz. - dauber top	12
65432	32 oz. - trigger spray	12
65273	1 gal.	4



#### FEATURES

- Fast acting
- Long lasting
- Easy to see bubbles
- Continuous bubbling

**APPLICATION** • Thick formula pinpoints the smallest natural gas, LPG and A/C refrigerant leaks with well defined elastic bubbles that stand up under pressure and windy conditions • Use on surface temperatures from 20°F to 250°F  
**Recommended for** • All types of pipe, tubing, valves, tanks, pressure vessels, condenser / evaporator coils, refrigeration coils, and many other similar applications



FBC™ System Compatible™ indicates that this product has been tested, and is monitored on an ongoing basis, to assure its chemical compatibility with FlowGuard Gold®, BlazeMaster® and Corzan® pipe and fittings. FBC™, FlowGuard Gold®, BlazeMaster® and Corzan® are licensed trademarks of The Lubrizol Corporation.

### RectorSeek™ Low-Temp

#### Low temperature leak locator

Code	Description	Qty.
61554	8 oz. dauber top	12
61434	16 oz. trigger spray	12
61273	1 gal.	4
61111	55 gal.	1

#### FEATURES

- Longer bubbling action
- Dauber or spray application
- Easy to apply

**APPLICATION** • Leak locator for use on pipes or tanks containing gases at low temperatures • Effective from -35°F to 200°F  
**Recommended for** • Pipes\*, tubing, valves, cylinders, tanks, pressure vessels, condenser / evaporator coils, refrigeration coils and many other similar applications

\*Call Technical Services for compatibility with plastic pipes.



### RectorSeek™ Mid-Temp

#### Normal temperature leak locator

Code	Description	Qty.
60554	8 oz. dauber top	12
60434	16 oz. trigger spray	12
60273	1 gal.	4
60111	55 gal.	1

#### FEATURES

- Longer bubbling action
- Dauber or spray application
- Easy to apply

**APPLICATION** • Leak locator for use at normal temperature on pipe or tanks that contain gases • Can be used on oxygen, air or gas at temperatures between 40°F to 200°F  
**Recommended for** • All types of pipe\*, tubing, valves, cylinders, tanks, pressure vessels, condenser / evaporator coils, refrigeration coils and many other similar applications

\*Call Technical Services for compatibility with plastic pipes.





# Heating Chemicals

Soot Removers

Fuel Oil Deodorizers & Absorbents

Boiler Products



## SOOT REMOVERS & BURNER CLEANERS

### Sootmaster™ Powder

Remove soot from oil & gas-fired burners

Code	Description	Qty.
68322	1 lb.	12

#### FEATURES

- Contains no lead

#### APPLICATION

- Works both by catalysis and supplying extra oxygen
- Applied by scattering or dusting surface with a sprayer
- Recommended for
- Oil & gas-fired burners

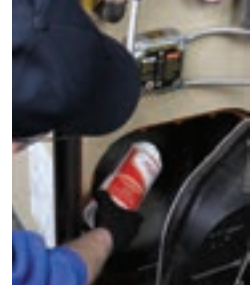

### Sootspray™

The original aerosol soot remover

Code	Description	Qty.
68342	14 oz. aerosol	12

#### FEATURES

- Contains no lead
- Cuts vacuum time by 50-100%
- Approved for Connecticut sale

#### APPLICATION

- Catalytically active for safest possible soot removal
- Reaches where vacuum cleaners cannot.
- Recommended for
- Oil & gas-fired burners

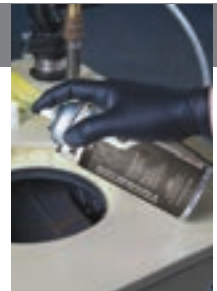

### Sootomagic™

The original soot stick

Code	Description	Qty.
6833	¼ lb. stick	48

#### FEATURES

- Contains no lead
- Non-corrosive / Non-explosive
- Fits through all combustion chamber openings
- Approved for Connecticut sale

#### APPLICATION

- Destroys soot quickly by catalytic low temperature ignition
- Residual soot removal coating works even after stick is consumed
- Recommended for
- Oil & gas-fired burners





## FUEL OIL DEODORIZERS & ABSORBENTS

### Odorgon™ Powder

Kills odors and absorbs oil

Code	Description	Qty.
68512	1 lb.	12
68514	2 lbs.	12

#### FEATURES

- Leaves pleasant scent
- Non-explosive / non-flammable

#### APPLICATION

- Handy for cleaning up after spills and oil leaks
- Sifter top for controlled economical usage and clean storage
- Recommended for
  - Spills • Oil leaks



### Odorgon™ Spray

Kills odors and absorbs oil

Code	Description	Qty.
68516	14 oz. aerosol	12

#### FEATURES

- Non-lingering, mild scent
- Non-flammable

- APPLICATION • Kills oil and other industrial odors
- Covers vertical surfaces and corners
- Recommended for
  - Spills • Oil leaks



### Neutroda™ Powder

Economic deodorizer & absorbent

Code	Description	Qty.
68502	1 lb.	12

#### FEATURES

- Very light weight makes volume equal to twice as much as Odorgon™ Powder

- APPLICATION • An economical version of Odorgon™ Powder, with a different fragrance and absorption system
- Recommended for
  - Spills • Oil leaks





## BOILER TREATMENTS

Water treatments & sealants for steam and hot water systems.

### 8-Way™

Water treatment for both steam and hot water systems

Code	Description	Qty.
68712	1 qt.	12
68714	1 gal.	4
68716	30 gal.	1

#### FEATURES

- Will not damage seals and gaskets
- Non-chromate; biodegradable
- No petroleum distillates

- APPLICATION**
- Removes sludge
  - Removes rust scale
  - Inhibits boiler corrosion
  - Inhibits steam line corrosion
  - Prevents oxygen pitting
  - Inhibits lime scale
  - Prevents surging and foaming
  - Controls pH with a color indicator
- Recommended for
- Boiler water



### Surgemaster™

Boiler water treatment

Code	Description	Qty.
68742	5.3 oz.	12

#### FEATURES

- Will not damage seals and gaskets
- Inhibits corrosion
- No petroleum distillates

#### APPLICATION

- Cures and prevents priming, surging & foaming
  - Sure-cure color indicator tints boiler water to take the guesswork out of treatment dosage
- Recommended for
- Steam boilers

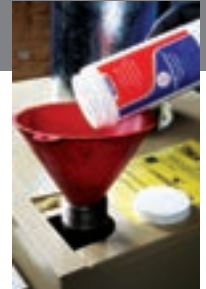

### Surgex™

Inhibits scale and corrosion

Code	Description	Qty.
68752	1-½ oz.	20

#### FEATURES

- Economical

#### APPLICATION

- Cure for foaming, surging and priming steam boilers
  - Concentrated anti-foam formula, color-coded to insure proper treatment
- Recommended for
- Steam boilers



## Steammaster™ Tablets

Concentrated, economical treatment

Code	Description	Qty.
68732	36 tab bottle	12

### FEATURES

- Will not damage seals and gaskets
- No petroleum distillates
- Built in color-cure indicator assures accurate treatment

### APPLICATION

- Removes and prevents scale and corrosion in steam and hot water systems
- Recommended for
- Steam & water systems

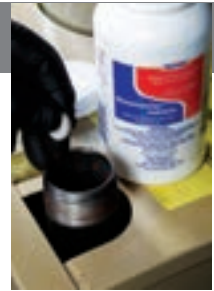

## Sealmaster™

Seals leaks in steam systems

Code	Description	Qty.
68722	1 qt.	12

### FEATURES

- Stops corrosion
- Will not damage seals and gaskets
- No petroleum distillates

### APPLICATION

- Fills and seals holes, cracks and loose joints in steam boilers
- Recommended for
- Steam boilers



## PyroSeal™

Furnace & retort cement

Code	Description	Qty.
68612	1-½ lb.	12
68614	3 lb.	12
68616	6 lb.	8
68618	12 lb.	4
68620	25 lb.	1

### FEATURES

- Shrink-proof, crack-proof
- Contains no asbestos or OSHA restricted fibers

### APPLICATION

- Smooth, creamy, easy-spreading furnace & retort cement that sticks where applied
  - For high temperature sealing & bonding
- Recommended for
- Combustion chambers
  - Furnace doors
  - Flue pipes

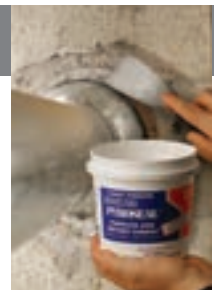



## HIGH STRENGTH CLEANER/DEGREASER

### Zipp™

Quick drying degreaser

Code	Description	Qty.
82642	14 oz. aerosol	12

#### FEATURES

- Cleaner / degreaser
- Leaves no residue
- Non-flammable
- Non-conductive

**APPLICATION** • Quick drying, safe solvent degreaser that instantly removes grease, oil, waxes, tar, gums, grime, dirt, carbon, greasy stains, bilge slime and similar soils from most hard surfaces

- Will not short out electrical equipment
- Recommended for use • Oil burner parts
- Compressors • Refrigeration units
- Greasy fan blades • Strainers • Engines
- Stoves • Relay contact points
- Electrical equipment



### Zipp™ II

Environmentally safer, quick drying degreaser

Code	Description	Qty.
82645	12 oz. aerosol	12

#### FEATURES

- Cleaner / degreaser
- Leaves no residue
- Non-flammable
- Non-conductive
- Non-chlorinated

**APPLICATION** • Quick drying, safe solvent degreaser that instantly removes grease, oil, waxes, tar, gums, grime, dirt, carbon, greasy stains, bilge slime and similar soils from most hard surfaces

- Will not short out electrical equipment
- Contains no carbon tet or restricted solvents
- Recommended for • Oil burner parts
- Compressors • Refrigeration units
- Greasy fan blades • Strainers • Engines
- Stoves • Relay contact points
- Electrical equipment



### Grime-Solv™

Foaming, heavy duty cleaner and degreaser

Code	Description	Qty.
88436	14 oz. aerosol	12

#### FEATURES

- Safe for metals
- Wipes clean or rinses with water
- Non-flammable
- Non-corrosive

**APPLICATION** • Lifts encrusted grime, grease or carbon • Use to remove stains from concrete driveways and brick walls, to clean white wall tires and for cleaning surfaces before painting

- Recommended for • Oil burner parts
- A/C and refrigeration equipment • Marine and automotive engines • Machinery that can be rinsed with water or wiped with a rag



# Specialty Products

Draft-Block

Lubricants

Galvanizing spray

Hornet spray

Epoxy putty

Duct seal

Hand cleaner

Roof odor control



## SPECIALTY AEROSOLS

### Draft-Block™ Expanding polyurethane foam

Code	Description	Qty.
96500	12 oz. aerosol	12

- Excellent filler which bonds and insulates
- Fill voids, cracks, crevices and small cavities on flat or irregular surfaces tack free in approx. 45 min.
- Expands 3X and reduces sound transmission
- No urea formaldehyde and totally dielectric



### Buz-Awf™ Wasp and hornet spray

Code	Description	Qty.
84390	16 oz. aerosol	12

- Kills wasps, hornets, yellow jackets and bees
- E.P.A. REG. NO. 3862-174-51219, E.P.A. EST. NO. 9143-TX-1
- Shoots high pressure 20 ft. stream
- Non-conductive up to 47kv



### Lets-Go™ Penetrant, lubricant and freeze-up preventer

Code	Description	Qty.
73012	12 oz. aerosol	12

- Covers metal surfaces with a clinging, tough, long-lasting film of lubricant
- Loosens frozen bolts, nuts & joints
- Protects from water & weather
- The wetting power acts quickly on rusted and seized parts
- Displaces moisture from wiring and equipment



### RectorSeal® EP-200 Epoxy Putty

Code	Description	Qty.
97600	2 oz.	24
97601	2 oz. refill	24
97602	Blister card	12
97606	EP-400 4 oz.	12

- Pre-measured, high-grade epoxy and hardener formulated together in one stick
- Break off the amount needed for each repair
- Hardens in minutes
- Bonds to most surfaces
- Can be drilled, taped, filed, machined, sanded and painted.



### Cold Galvanizing Spray Protection of hot-dip

Code	Description	Qty.
86625	16 oz. aerosol.	12

- Stops rust and corrosion, indoor and outdoors
- Contains 95% pure zinc and forms a tough, durable and flexible zinc metal coating that bonds electrochemically with the base metal to protect against rust and corrosion
- To prevent and retard rust and corrosion on welded joints, fencing, storage tanks, pipe lines, metal building, marine and other similar applications.



### RectorSeal® Duct Seal Gray putty compound

Code	Description	Qty.
81880	1 lb.	10
81881	5 lbs.	2

- Permanently soft, non-toxic, putty-type compound which adheres to most clean, dry surfaces
- Can be hand applied from 25°F to 120°F
- Seals around the ends of electrical conduits and boxes
- Flashings
- Service mast entries
- Air / water tight seal
- Resistant to water, alcohols, mild acids & bases
- Non-corrosive / non-irritant





## MISCELLANEOUS

### Magne-Patch® Instantly stops small leaks in steel tanks

Code	Description	Qty.
68442	Blister card	12

- A powerful, permanent magnet holds a flexible plug against the hole and against existing pressure • For steel tanks
- Quickest tank repair available
- Can be reused



### GOJO® Hand cleaner

Code	Description	Qty.
40500	Original 14 oz. tub	12
40507	Natural orange 14 oz.	12

- Thoroughly and safely cleans adhesives, asphalt, tar and paint
- Safe to use • Non-toxic
- Biodegradable



\*GOJO is a registered trademark of GOJO Industries

### SureSeal® VentGuard Roof vent odor control

Code	Description	Qty.
97065 (SS214VG)	2" Vent Seal	6
97066 (SS314VG)	3" Vent Seal	6
97068 (SS414VG)	4" Vent Seal	6

- Press-fit into roof stack • Controls roof vent & grease interceptor odors • Stops roof odors from migrating back in through indoor air ducting • Stops roof vent pipe nesting • Carbon black infused for UV protection • Can be used on older roof vents
- Three Vent-Guard sizes fit all 2", 3" and 4" roof vent piping.



US Patent 9,416,986 B2

### PRO-Fit™ Precision Flaring kit

Code	Description	Qty.
87001	PRO-Fit™ kit	1
87002	1/4" Replacement Hex Bit	6
87003	3/8" Replacement Hex Bit	6
87004	1/2" Replacement Hex Bit	6
87005	5/8" Replacement Hex Bit	6
87006	3/4" Replacement Hex Bit	6

- Creates precise and fast standard 45° flares in copper and aluminum line sets for mini-split HVAC units • Tip guides the flaring bit into the tube & forms a standard 45° flares • Stopper ensures a consistent length of the flare surface • Standard 1/4" hex shank fits directly into most power tools without an adapter



# INDEX OF PRODUCTS

100 Series ClearTrap kits	19	Drop Ceiling Flanges	53	Heating Chemicals	98	LP92	58
100 Series Waterless kits	21	Duplex Stand	75	H-Frame	72	LT122	58
200 Series SmartTrap kits	20	Easy Klear	35	Hose Coupler	15	LP92	58
220 Series Overflow Switches	20	Equipment Mounting	66	Hot 203L	85	LT122	58
600 Series Combo kit	21	EZT113	19	Hurricane Bracket	74	LT92	58
8-Way	100	EZT113B	19	Hydrex A/C Tabs	35	LW122	58
Acid-Away	43	EZT119	19	Ice Machine Cleaner	95	LW92	58
Acid-Away for POE	43	EZT150	21	Insulated Drain Hose	14	LWF122	58
Acid-Detector	45	EZT180	21	Interconnect Cable	15	LWF92	58
Acid-Detector for POE	45	EZT205	20	Jim PR-1L	84	Magne-Patch	105
AC Leak Freeze	40	EZT207	20	K.O. Dirt Blaster	92	Metacaulk 1000	88
Actabs	35	EZT210	20	Kickstart	44	Metacaulk 350i	89
AG-1100+	22	EZT224	20	LCF1122	58	Metacaulk 835+	89
AG-1200+	22	EZT225	20	LCF192	58	Metacaulk MC 150+	89
AG-2510	25	EZT226	20	LCFO122	58	Metal Pipe Hanger	80
AG-1250E	23	EZT228	20	LCFO92	58	microV	9
AG-2550E	23	EZT230	20	LCI122	58	Mighty Bracket	77
AG-3125E	24	EZT405	19	LCI92	58	Mighty Pump	36
AG-3150E	24	EZT406	19	LCO122	58	Mini Pump Pre-filter	79
AG-3175E	25	EZT626	21	LCO92	58	Mini-Split Pump Kits	4
AG-3180E	26	Fast Fix Stands	70	LD122	58	Multi-Foot	72
AG-4200E	27	Fix-It-Foot	73	LD92	58	Mini Tank Pump	12
AG-4200M	27	Fix-It-Foot Low	73	LDC	58	MV2	50
AG-4250E	28	Foam-A-Coil	93	LDK92B	59	MV2S	50
AG-9100	28	Fortress Lineset Covers	56	LDK122B	59	MV3	50
AG-9150E	29	Gene404L	84	LDK92G	59	MV360	50
AG-9300	29	GOJO	105	LDK122G	59	MV360S	50
Air Conditioning Chemicals	92	Goliath Pans	30	LDK92I	59	MV3S	50
Air Diffusers	48	Goliath Furnace Pans	33	LDK122I	59	MV4	50
Airtec Classic	52	Goliath Furnace Risers	34	LDK92W	59	MV4S	50
Airtec Grilles Only	52	Goliath Value Series Pans	31	LDK122W	59	MVAB	51
Airtec Retro	52	GR2	53	LDR12292	58	MVASB	51
Airtec Tuffbox	54	GR2S	53	LEN122	58	MVASW	51
Aqua Pump Series	6	GR3	53	LEN92	58	MVAW	51
Arctic 616L	85	GR360	53	Lets-Go	104	MVE	51
Aspen Pumps	4	GR360S	53	LF122	58	MVES	51
Aspen Xtra	78	GR3S	53	LF92	58	MXE	51
Better Bubble	96	GR4	53	LFJ122	58	MXES	51
Big Foot	66	GR4S	53	LFJ92	58	Neutroda Powder	99
Buz-Awf	104	GRAB	53	Lime Pump Series	8	Nickel-Safe Ice Machine Cleaner	95
Ceiling Support Flanges	53	GRASB	53	Limited clearance grille/damper	52	NoKink	76
Cleaner & Treatments	95	GRASW	53	Lineset Covers	56	Nokorode Regular	86
Clean-N-Safe	92	GRAW	53	Liquid Descalit	95	Non-Adhesive Wrap	15
ClearTrap Accessories	19	GRD2	53	LJ122	58	Non-Insulated Drain Hose	14
Coil-Rite	93	GRD3	53	LJ92	58	Novent Green	63
Cold Galvanizing Spray	104	GRD360	53	LK122	58	Novent Keys	64
Compressor Maintenance	37	GRD4	53	LK92	58	Novent Pink	63
CTT-Tablets	95	GRDAB	53	LKF122	58	Novent Silver	63
Cube & Beam	69	GRDAW	53	LKF92	58	Novent Starter Pack	64
Desolv	94	GRDE	53	LKS122	58	Nu Line	35
Desolv Cleaning Kit	94	GRE	53	LKS92	58	Odorgon Powder	99
Directional Cleanout Tool	16	GRES	53	Locking Refrigerant Caps	62	Odorgon Spray	99
Draft Block	104	Grime-Solv	102	LP122	58	Oil-ID	45

Open Mesh Sandcloth	86	SJ140	60
Orange Pump Series	7	SJ77	60
Paircoil	76	SK100	60
Perisaltic Pump Series	11	SK140	60
Pipe Adapter	15	SK77	60
Pipe Ties	80	SKF100	60
Polymer Risers	73	SKF140	60
PRO-Fit Flare Tool	105	SKF77	60
Pyroseal	101	SL300	60
RectorSeal Duct Seal	104	Slab Stand	75
RectorSeal EP-200	104	SlimDuct Lineset Covers	56
RectorSeal Hi-Temp	90	SN77	60
RectorSeal RS 136	90	Slope Stand	75
RectorSeal Silicone Sealant	90	Sootmaster Powder	98
RectorSeal No. 5	82	Sootomagic	98
RectorSeal No. 5 Sub Zero	82	Sootspray	
RectorSeal No. 7	83	SP100	
RectorSeal T plus 2	83	SP140	
RectorSeal Tru-Blu	83	SP77	
RectorSeek Low-Temp	96	Speciality Chemicals	
RectorSeek Mid-Temp	96	SS 103 E	
Rectorshield	86	SS 500 EP	
Refresh Tablets	95	SS 610 E	
Renewz	93	SS 700 E	
Rubber Adapter	79	SS1	
SC100	60	SS2	
SC140	60	SS2AP	
SC77	60	SS3	
SCF100	60	ST100	
SCF140	60	ST140	
SCF77	60	ST77	
SD100	60	Steammaster Tablets	
SD140	60	SureSeal Vent-Guard	
SD77	60	Surgemaster	
SDK77	60	Surgex	
SDK100	60	SW100	
SDR10077	60	SW140	
SDR140100	60	SW77	
Sealmaster	101	Titan Pans	
SEN100	60	Turbo-Kleen	
SEN140	60	Under Window Bracket	
SEN77	60	Vented Drain WYE	
SF100800	60	VRF Frameworks	
SF140800	60	Wall Bracket	
SF77500	60	Wall Sleeve	
SFJ100	60	White Pump Series	
SFJ77	60	Xtra Kit	
SFS100	60	Zipp	
SFS140	60	Zipp II	
SFS77	60		
SIF100	60		
SIF77	60		
SJ100	60		

## About RectorSeal



Founded in 1937, RectorSeal is a leading manufacturer of chemical specialty sealants and other related products designed for professional tradesmen.

An extensive wholesale distribution network serves the plumbing, industrial, HVAC-R, construction, electrical and hardware marketplaces.

Primary HVAC-R products include chemical cleaners, leak locators, condensate management products, mini-split accessories, and compressor maintenance products,

Leading brands include:

Acid-Away®	Safe-T-Switch®	Airtec®
Renewz™	Fortress®	Novent®
Kickstart®	Goliath®	



A CSW Industrials Company

Through the use of current technology and social media, RectorSeal provides support for all chemicals and mechanical products and tools including:

- Technical information
- Marketing materials
- Product installation training videos
- Product codes
- SDS and product data sheets.
- Trade show scheduling

HVAC-R



A CSW Industrials Company

INNOVATIVE PRODUCTS FOR THE TRADES

rectorseal.com



Firestopping



Plumbing



Electrical

---

Represented By: