

Drop-In Refrigeration System

Original Instructions

Installation, Operation and Maintenance Manual

This manual is updated as new information and models are released. Visit our website for the latest manual.

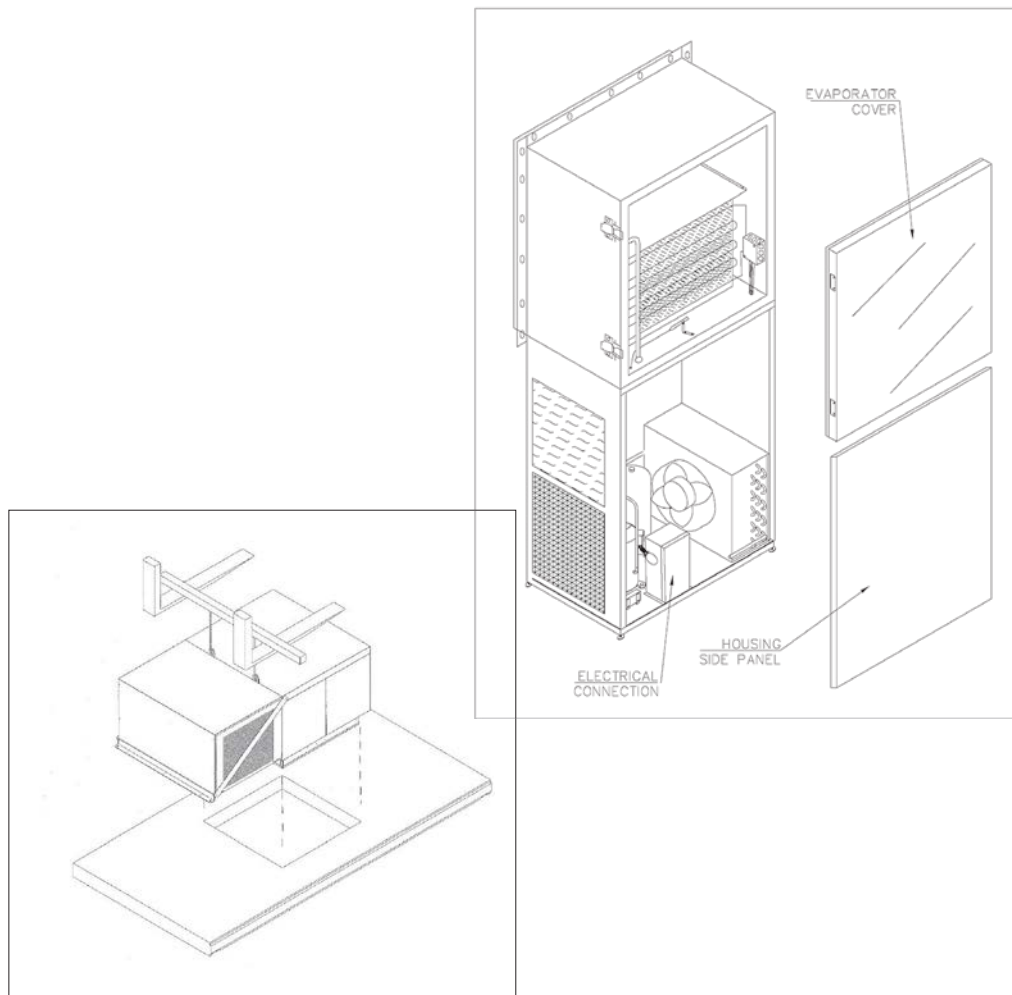

Safety Notices

DANGER

Indicates a hazardous situation that, if not avoided, will result in death or serious injury. This applies to the most extreme situations.

Warning

Indicates a hazardous situation that, if not avoided, could result in death or serious injury.

Caution

Indicates a situation that, if not avoided, could damage the refrigeration system or result in minor injury.

Notice

Indicates information considered important, but not hazard-related (e.g. messages relating to property damage).

NOTE: Indicates useful, extra information about the procedure you are performing.

Warning

Read this manual thoroughly before operating, installing or performing maintenance on the equipment. Failure to follow instructions in this manual can cause property damage, injury or death.

Caution

Installation and maintenance/servicing are to be performed only by trained and qualified personnel familiar with commercial refrigeration systems.

Caution

Ensure that all field wiring conforms to the equipment requirements and all applicable local and national codes.

Caution

Disconnect all power sources before servicing the refrigeration equipment.

Caution

Sheet metal and coil surfaces have sharp edges. Use appropriate protective gloves to prevent injury.

Caution

Use appropriate eye protection during installation and servicing.

Table of Contents

Section 1

General Information

Receiving Inspection	4
Warranty Information	4

Section 2

Installation

Walk-In Installation	5
Clearance Requirements	5
Roof Curb and Membrane – Outdoor Models Only	6
Top Mount Models Installation	7
Installing Unit to Ceiling Panel	7
Top Mount Wiring and Electrical Connections	7
Top Mount Drain Line – Outdoor Models Only	7
Side Mount Models Installation	8
Installing Unit to Wall Panel	8
Side Mount Wiring and Electrical Connections	8
All Models Start-Up	9

Section 3

Operation

Thermostat	10
Adjusting the cut-off temperature	10
Adjusting the cut-on temperature	11
Anti-Short Cycle Delay Feature (ASD)	11
Sensor Failure Action Feature (SF)	11
Electric Defrost Timer (Freezers)	12
Air Defrost Timer (Coolers)	13

Section 4

Maintenance

Maintenance Chart	14
-------------------------	----

Section 1

General Information

Receiving Inspection

1. Check the shipment carefully and compare to the bill of lading.
2. Account for all items listed and inspect each container for damage.
3. Carefully inspect for any concealed damage.
4. Report any shortages or damages to the carrier, note on the bill of lading, and file a freight claim.
5. Damaged material cannot be returned to the manufacturer without prior approval.
6. A Return Material Authorization (RMA) must be obtained. Contact a sales representative at 800-826-7036.

Warranty Information

For information regarding warranty guidelines, claim form, product registration, warranty verification, or locating a service provider please visit our website at www.kolpak.com or call 800-225-9916.

Section 2 Installation

Walk-In Installation

Installation and operation instructions for the walk-in are provided separately. A copy of this manual can be obtained from the website at www.kolpak.com or by calling technical service at 800-225-9916.

Clearance Requirements

⚠ Caution

Failure to observe clearance and air flow requirements will result in poor system performance, premature equipment failure, and inability to service the system!

- A minimum of 18"/46cm clearance is required on all sides of the unit to allow proper air flow and serviceability of the system.
- A supply of clean ambient air or ventilated air is required to maintain acceptable condensing temperatures (less than 110°F/43°C ambient) and allow removal of heated discharge air from the condensing unit area.

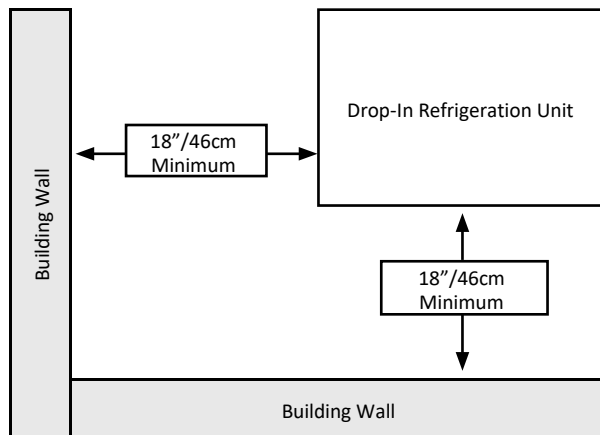

Example of Minimum Clearance Requirements

Roof Curb and Membrane – Outdoor Models Only

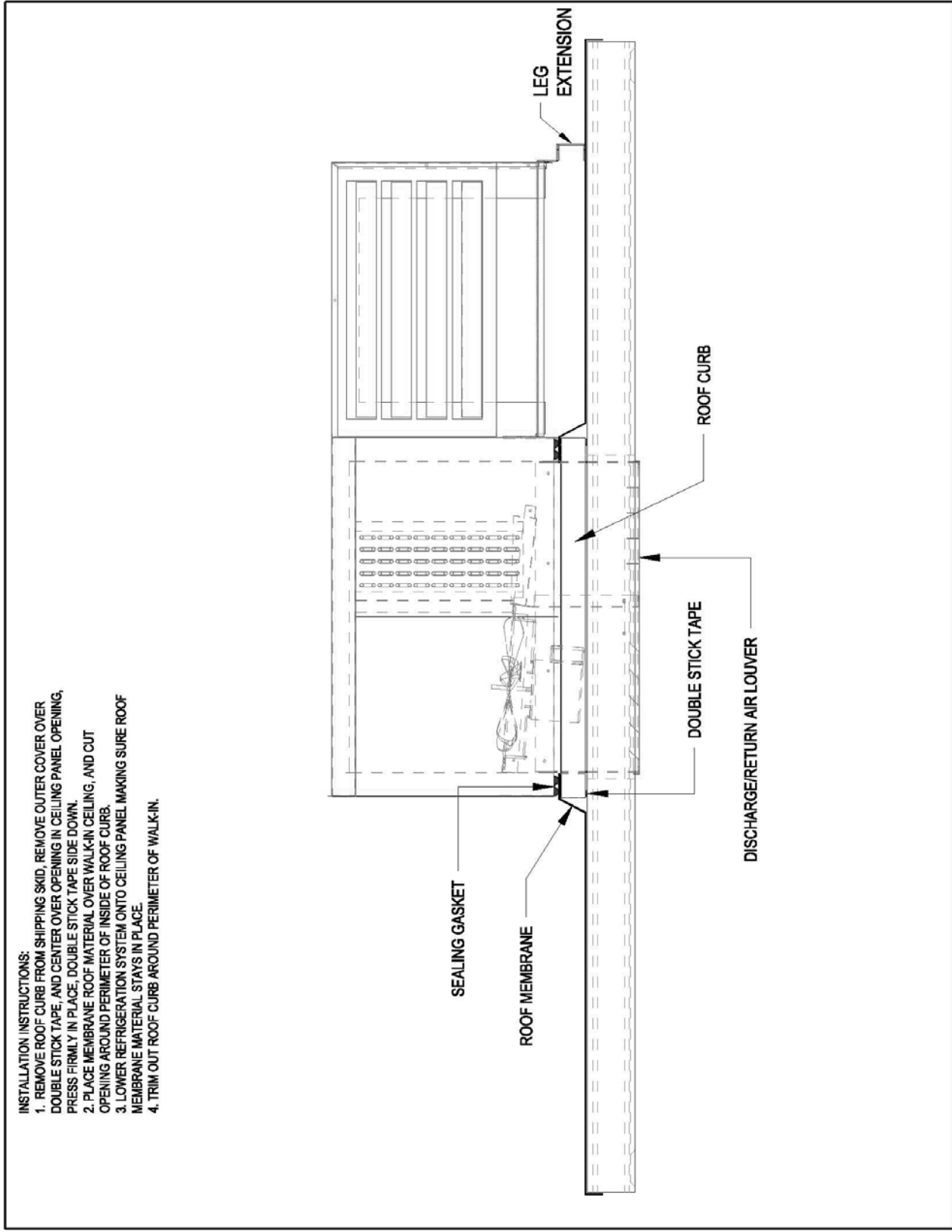

Top Mount Models Installation

Warning

Do not lift the unit by the refrigerant tubing or other components. These features will not support the unit weight. Injury and unit damage may occur!

INSTALLING UNIT TO CEILING PANEL

1. Lift the unit from its shipping crate using the lift rings located on top of the unit.
2. Center the evaporator air intake/discharge over the panel opening and lower into position.
3. To ensure there is no air infiltration into the walk-in, the gasket around the evaporator box must seal around the panel opening.
 - A. Loosen the screws with slotted holes that connect the condensing unit to the evaporator box.
 - B. Push down on the evaporator box to ensure the gasket is sealed.
 - C. Check to ensure the condensing unit base is level and supported, then retighten the screws.
4. Once the unit is level and sealed, secure the unit to the ceiling panel.
5. Remove the diagonal shipping braces from the condensing and louvered ends of the unit.

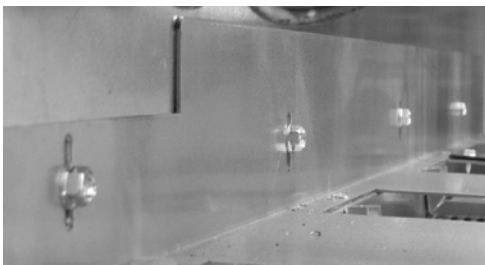
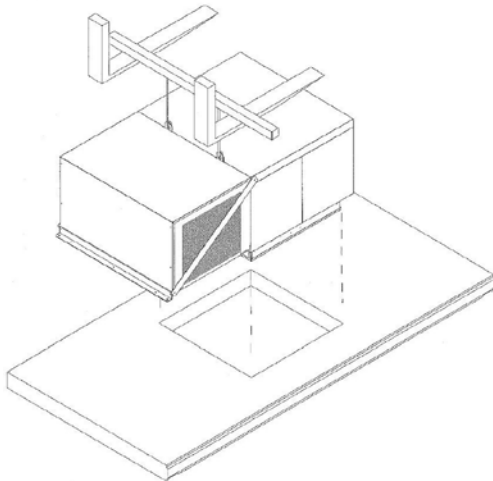

TOP MOUNT WIRING AND ELECTRICAL CONNECTIONS

Warning

All wiring must comply with local and national codes. Wiring must be performed only by a refrigeration technician or certified electrician. Failure to follow these guidelines may result in injury!

Caution

Check all wiring connections, including factory terminals, before operation. Connections can become loose during shipment and installation.

- All electrical connections and routing must comply with local and national codes.
- Do not modify the factory installed wiring without written factory approval.
- Refer to the serial plate on the unit to determine the proper electrical power supply.
- Wire type should be of copper conductor only and properly sized to handle the electrical load.
- Unit wiring diagrams are attached inside the electrical box cover.
- The electrical box is located behind the condensing unit housing louver.

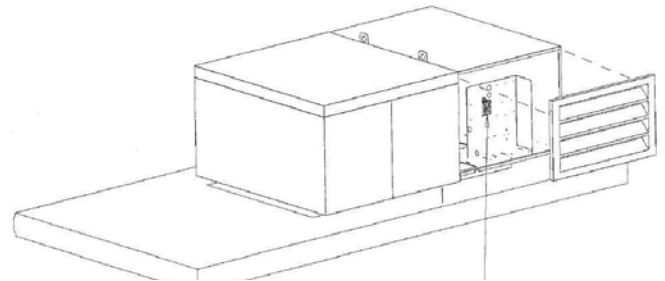

TOP MOUNT DRAIN LINE – OUTDOOR MODELS ONLY

1. Connect a copper drain line to the evaporator drain using a compression fitting. Do not reduce the drain line size.
2. Slope the drain line a minimum of ½"/13mm per foot to allow proper drainage.
3. The drain line must be wrapped with heat tape and insulated with a minimum ½"/13mm thick Armaflex.
4. Install a P-trap in the drain line to prevent the suction of ambient temperatures into the evaporator compartment which can lead to excessive humidity and icing issues.

Side Mount Models Installation

⚠ Warning

The Side Mount Unit is top heavy and can easily tip over causing injury and unit damage!

INSTALLING UNIT TO WALL PANEL

1. Position the unit as close as possible to the walk-in before removing from the shipping skid.
2. Remove the system from the shipping skid and carefully slide the unit into the wall panel opening.
3. Level the unit by adjusting the leveling legs.
4. There are rivnuts around the perimeter of the opening. Using the supplied bolts, attach the unit to the walk-in by the flange around the evaporator compartment.
5. Tighten the bolts until the gasket material is compressed to a thickness of approximately 1/8"/3mm.
6. Apply a 3/8"/10mm bead of silicone around the perimeter of the evaporator compartment to ensure an air tight seal.

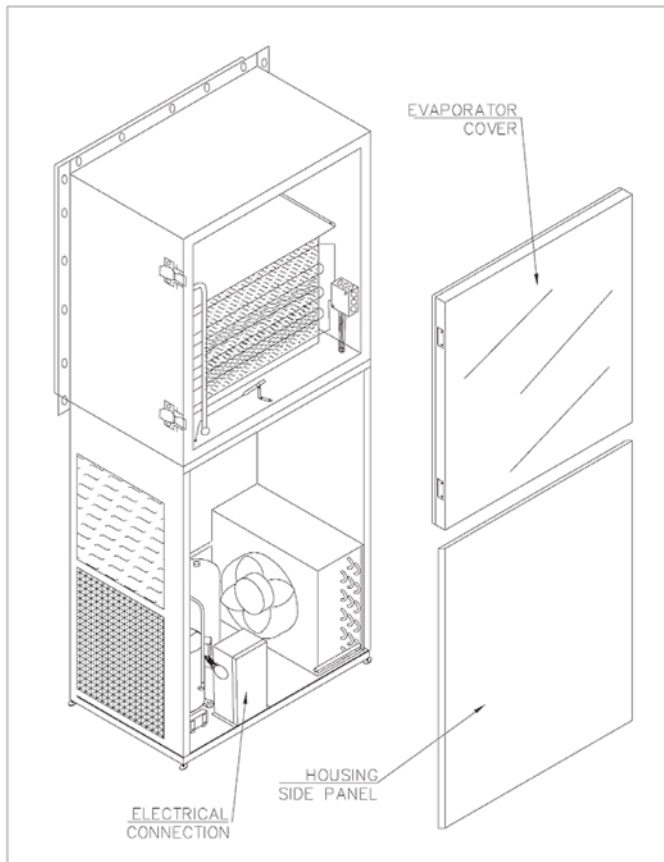

SIDE MOUNT WIRING AND ELECTRICAL CONNECTIONS

⚠ Warning

All wiring must comply with local and national codes. Wiring must be performed only by a refrigeration technician or certified electrician. Failure to follow these guidelines may result in injury!

⚠ Caution

Check all wiring connections, including factory terminals, before operation. Connections can become loose during shipment and installation.

- All electrical connections and routing must comply with local and national codes.
- Do not modify the factory installed wiring without written factory approval.
- Refer to the serial plate on the unit to determine the proper electrical power supply.
- Wire type should be of copper conductor only and properly sized to handle the electrical load.
- Unit wiring diagrams are attached inside the electrical box cover.
- The electrical box is located behind the condensing unit housing side panel.

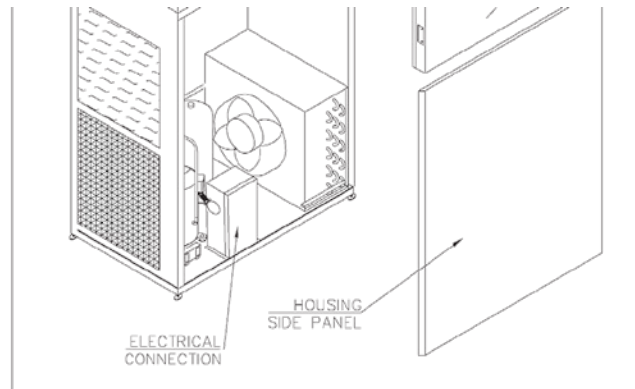

All Models Start-Up

The Drop-In refrigeration systems are designed for quick and easy startup.

1. Make electrical connections as directed by the wiring diagram. Set the defrost control time and verify the defrost initiation settings. Electric Defrost Timer (Freezers) additional details on page 12. Air Defrost Timer (Coolers) is incorporated into the Air Defrost Thermostat. There is no separate Air Defrost Timer. Additional details are on page 13.
2. Verify/Set the temperature control to desired temperature range. See page 10 for instructions on how to adjust the Thermostat.
 - Coolers are factory preset to 35°F/2°C.
 - Freezers are factory preset to -10°F/-23°C.
3. Replace all electrical box covers, housings, etc.
4. File a copy of this manual for future reference.

Section 3 Operation

Caution

Do not block the supply and return air grills or the air space around the air grills. Keep plastic wrappings, paper, labels, etc. from being airborne and lodging in the grills. Failure to keep the air grills clear will result in unsatisfactory operation of the system.

The Drop-In refrigeration systems are of the draw through design. The walk-in air is drawn into the supply air grill, through the evaporator coil, and discharged out the return air grill into the walk-in. Any interruption or obstruction of the supply or return air streams will result in unsatisfactory operation of the system.

- Coolers: When powered on, the evaporator fan(s) run continuously, even during defrost cycles, and the condensing unit will cycle on/off to maintain the walk-in temperature.
- Freezers: When powered on, the evaporator fan(s) run continuously except when the system is in defrost and for a short period after the defrost cycle is complete. The condensing unit will cycle on/off to maintain walk-in temperature.

NOTE: Walk-in temperatures will elevate above the set point during defrost cycles (approximately 30 – 45 minutes, 4 times per day) but will return to the set point once the defrost cycle is complete.

Thermostat





- The body of the thermostat is mounted inside the condenser compartment on both Top Mount and Side Mount models.
- The sensing bulb is placed in the return air stream inside the evaporator compartment.
- The thermostat on Top Mount models can be accessed by removing the louvered front panel.
- The thermostat on Side Mount models can be accessed by removing the left side panel on the condensing unit assembly.











Air Defrost Thermostat



Electric Defrost Thermostat

	Red Light - Not used
	Yellow Light - Non-critical alarm (system running)
	Green Light - System running
	Green Flashing - System waiting on minimum on/off timer to start/stop

- Access Setpoint mode by pressing and holding the  button until **tS** (Temperature setpoint) displays on the screen.
- Use the  up and  down arrows to scroll through the available setpoints.
- Press  to view the current setting.
- Use the  up and  down arrows to change the setpoint .
- Press and hold the  button to confirm each setpoint change.
- Press the  button to escape.

tS = Temperature setpoint

diF = Differential

CSH = Maximum compressor starts/stops

dPd = Defrost per day

tod = time of day (only used when custom defrost is selected)

dFt = Defrost time

HAO = High Alarm Offset

LAO = Low Alarm Offset

tAd = Temperature Alarm Delay

Adr = Mod Bus Address

Unt = Ynits for temperature display (FAH or CEL)

Basic Setpoints

Setpoint	Description	Minimum	550005663 Default	550005664 Default	Maximum
tS	Temperature Setpoint	-50°F (-45°C)	35°F	10°F	100°F (38°C)
diF	Differential	1°F	3.5°F	3.5°F	30°F
CSH	Maximum Compressor Starts/Hour	5 (Off)*	0 (off)	0 (off)	10
dPd	Defrost Per Day	0	4	0	12, CUS**
dFt	Defrost Time	0 min	30 min	0 min	720 min
HAO	High Alarm Offset	1°F	10°F	10°F	10°F
LAO	Low Alarm Offset	1°F	5°F	5°F	10°F
tAd	Temp Alarm Delay	1 min	60 min	60 min	180 min
Adr	Mod Bus Address	1	1	1	247
Unt	Units for Temp. Display	FAH	FAH	FAH	CEL

*Selecting fewer than 5 compressor starts per hour results in the starts per hour feature being turned off. The compressor will then function on temperature only.

** Selecting CUS (custom) unlocks 12 tod (time of day) defrost setpoints.

Custom tod (Time of Day) Defrost Setpoints

Setpoint	Description	Minimum	Default	Maximum
tod	Time of Day	0.0	12.0	23.5
d1	Start time of day #1	0.0	dis (disabled)	23,dis (disabled)
d2	Start time of day #2	0.0	dis	23,dis
d3	Start time of day #3	0.0	dis	23,dis
d4	Start time of day #4	0.0	dis	23,dis
d5	Start time of day #5	0.0	dis	23,dis
d6	Start time of day #6	0.0	dis	23,dis
d7	Start time of day #7	0.0	dis	23,dis
d8	Start time of day #8	0.0	dis	23,dis
d9	Start time of day #9	0.0	dis	23,dis
d10	Start time of day #10	0.0	dis	23,dis
d11	Start time of day #11	0.0	dis	23,dis
d12	Start time of day #12	0.0	dis	23,dis

Note: The time of day defrost setting use military time. The first 2 digits are the hour and the 1 digit after the decimal is the minutes.

Custom Defrost Setup

The following steps will guide you through the setup of the custom defrost feature.

Abbreviations:

- CUS = custom
- d1 = custom defrost 1
- dis = disabled
- dPd = defrosts per day
- tS = temperature setpoint
- tod = time of day



STEP 1
Press and hold the **ENTER** button, tS is displayed on the LEDs



STEP 2
Press the **▲** up arrow until dPd is displayed,



then press **ENTER**, 6 (default) will be displayed.



STEP 3
Press the **▲** up arrow until CUS is displayed.



Press and hold the **ENTER** button for 3 seconds until the dPd is displayed.



STEP 4
Press the **▲** up arrow until tod (time of day) is displayed,



then press **ENTER**

Use the **▲** up arrow and **▼** down arrow to set the time.

Note: The time is displayed in military time (24-hr clock) The 1st 2 digits are the hour. The minutes are after the decimal. Since there are only 3 digits, the time will be set to the nearest 10 minutes. See examples below.

Examples:
8:10 am would be 8.1 on the controller's display



4:32 pm would be 16.3 on the controller's display.



After the time is set, press and hold the **ENTER** button for 3 seconds, until tod is displayed



STEP 5
Press the **▲** up arrow to display Defrost 1 (d1).



To set the first defrost, press **ENTER** button.

dis (disabled) will be displayed.



Use the **▼** down arrow to set the defrost time.

Note: Defrost times may only be set on the hour.

Example:

2:00 am would be 2



Once the correct time is displayed, press and hold the **ENTER** button until d1 is displayed.



STEP 6
Repeat steps as necessary for d2 to d12.



STEP 7
Press the **BACK** button to save settings, and return to the main screen (room temp will be displayed).

Electric Defrost Timer (Freezers)

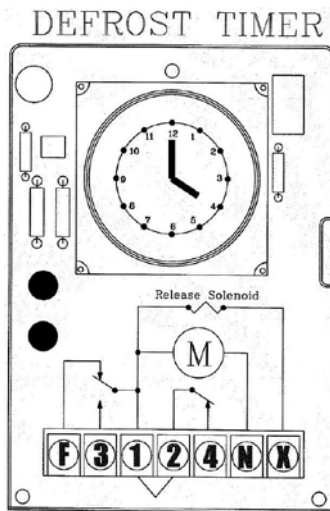

Defrost Time Clock

- The defrost timer clock must be set to the correct time at initial start-up and after any power interruptions.
- Set the clock by rotating the clock face until the correct time is at the arrow on the face of the timer.
- The switch is programmed by pushing the captive trippers to the inner ring for the entire period the load is to be turned "ON".
- When a tripper is pushed to the outside, the switch is in the "DEFROST" position.
- Each defrost tripper represents 15 minutes of defrost time.
- The timer is factory set for four defrost cycles daily at the following times: 4:00AM, 10:00AM, 4:00PM, and 10:00PM. Each defrost cycle is programmed for 30 minutes duration.
- The defrost times can be changed to initiate at periods of low activity.
- A setting of two to four defrost cycles per day is typical. For heavier frost loads, additional cycles may be required.
- The timer starts the defrost cycle automatically at the predetermined times.

NOTE: If the defrost termination thermostat fails to close, the fail safe setting on the timer will terminate the defrost cycle.

When the defrost cycle begins:

1. The compressor and evaporator fan motors will stop.
2. The evaporator coil heaters will activate and increase the coil temperatures above 32°F/0°C, melting the frost and ice.

NOTE: Walk-in temperatures will elevate above the set point during defrost cycles (30 minutes, 4 times per day) but will return to the set point once the defrost cycle is complete.

3. When the defrost time is complete or the evaporator coil warms to approximately 55°F/13°C, the compressor will start the refrigeration cycle but the evaporator fan(s) will remain idle until the evaporator coil temperature is at or below freezing.
4. Once the evaporator coil temperature reaches approximately 30°F/-1°C, the evaporator fan(s) will activate.
5. The system operates in the refrigeration cycle until another defrost cycle is initiated by the timer.

Air Defrost Timer (Coolers)

- The defrost timer is incorporated into the Air Defrost Thermostat. There is no separate Air Defrost Timer.
- The defrost timer is factory set for four defrost cycles daily at the following times: 4:00AM, 10:00AM, 4:00PM, and 10:00PM. Each defrost cycle is programmed for 30 minutes duration.
- The defrost times can be changed to initiate at periods of low activity.
- The timer starts the defrost cycle automatically at the predetermined times.
- A setting of two to four defrost cycles per day is typical. For heavier frost loads, additional cycles may be required.

When the defrost cycle begins:

1. The compressor will stop but the evaporator fan(s) will continue to run.
2. Air is pulled across the evaporator coil without refrigerant running through the system. The coil temperature to increases above 32°F/0°C melting the frost and ice.
3. The system remains in defrost through the duration programmed on the timer. Once the duration is complete, the compressor activates and refrigerant starts cycling through the system.
4. The system operates in the refrigeration cycle until the next defrost cycle is initiated by the timer.

Section 4 Maintenance

 **Caution**

Failure to keep the condenser coil clean will result in reduced airflow through the condenser, resulting in poor system performance and premature compressor failure.

Maintenance Chart

Area	Task	Frequency
Evaporator	Check for proper defrosting	Monthly
	Clean the coil and drain pan	Every 6 months
	Check for proper drainage	
Condenser	Inspect /clean the coil if the air supply is near polluting sources (such as cooking appliances)	Monthly
	Clean the coil surface	Every 6 months
General	Check/tighten all electrical connections, wiring, and insulators	Every 6 months
	Ensure the defrost time clock is set	
	Ensure all fan motors are working and do not have excessive vibration	
	Ensure all housings, covers, and guards are in place and tight	
	Check all fan motors	
	Check operation of the drain line heater and examine the heater and drain line for cuts and abrasions (outdoor models)	

WWW.WELBILT.COM

Welbilt provides the world's top chefs, and premier chain operators or growing independents with industry leading equipment and solutions. Our cutting-edge designs and lean manufacturing tactics are powered by deep knowledge, operator insights, and culinary expertise. All of our products are backed by KitchenCare® – our aftermarket, repair, and parts service.

▶ CLEVELAND
▶ CONVOTHERM®

▶ DELFIELD®
▶ FITKITCHEN™

▶ FRYMASTER®
▶ GARLAND

▶ KOLPAK®
▶ LINCOLN

▶ MANITOWOC®
▶ MERCÓ®

▶ MERRYCHEF®
▶ MULTIPLEX®