

Kolpak/RDI Refrigeration System Installation & Operation Manual



Kolpak
2915 Tennessee Avenue North
Parsons, TN 38363
Phone: 800-225-9916
www.kolpak.com

550006500
August 2018

Table of Contents

Safety Information	3
Receiving Inspection	3
Locating and Mounting Condensing Units	4-5
Locating and Mounting Evaporator Coils	5-6
Wiring	7
Piping.....	7-11
Leak Test.....	11-12
Evacuation	12-13
Refrigerant Charging.....	13
Suction/Liquid Line Sizing Chart	14-15
Operational Start-Up	15-16
Compressor Superheat.....	16-17
Evaporator Superheat	17-18
Thermostat.....	19-23
Electric Defrost Timer.....	24
Maintenance	25
Evaporator Troubleshooting	26
Condensing Unit Troubleshooting	27-28
System Start-Up Checklist	29-32
Warranty Information.....	33

General Safety Information

Read this manual carefully before beginning the installation and operation of the refrigeration system. Special attention is required to all sections identified with the following warning and caution notices provided in both English and French languages:

WARNING

Text in a Warning box alerts you to a potential personal injury situation. Read each Warning statement before proceeding and work carefully.

CAUTION

Text in a Caution box alerts you to a situation in which you could damage the refrigeration system. Read each Caution statement before proceeding and work carefully.

Disregarding these special notices may result in personal injury and/or damage to the refrigeration system.

Safety Notices

- Installation and maintenance/servicing are to be performed only by trained and qualified personnel familiar with commercial refrigeration systems.
- Ensure that all field wiring conforms to the equipment requirements and all applicable local and national codes.
- Disconnect all power sources before servicing the refrigeration equipment.
- Sheet metal and coil surfaces have sharp edges. Use appropriate protective gloves to prevent injury.
- Use appropriate eye protection during installation and servicing.

Receiving Inspection

Check the shipment carefully and compare to the bill of lading. Account for all items listed and inspect each container for damage. Carefully inspect for any concealed damage. Report any shortages or damages to the carrier, note on the bill of lading, and file a freight claim.

Damaged material cannot be returned to the manufacturer without prior approval. A Return Material Authorization (RMA) must be obtained. Contact a sales representative at 800-826-7036.

Locating and Mounting Condensing Unit

General Guidelines

- Check the selected installation location to ensure that racks, braces, flooring, foundations, etc. are adequate to support the condensing unit weight.
- The installation location is clean, dry, and level.
- Locate away from corrosive and noise sensitive atmospheres.
- Use the condensing unit skid and base when moving the unit. Do not remove unit from skid until the unit is moved to the mounting location.
- Mount the condensing unit base to pads or structural rails using properly sized bolts through the unit base. Center of condensing unit needs to be properly supported.



Correct



Incorrect

⚠ WARNING

Do not lift the condensing unit by the refrigerant tubing or components. These features will not support the condensing unit weight. Injury and unit damage may occur!

General Guidelines - Condensing Unit Locating and Mounting (continued):

Clearance Requirements

- Locate where there is a sufficient and unrestricted supply of clean ambient air.
- Locate where there is adequate space for the removal of the heated discharged air from the condensing unit area.
- Do not position multiple units so that discharge air from one unit is blowing into the condenser inlet air of the other unit.
- All sides of the unit should be positioned a minimum distance equal to the total width of the condensing unit away from any other unit, wall, or obstruction.

Example of Multiple Units with Horizontal Airflow

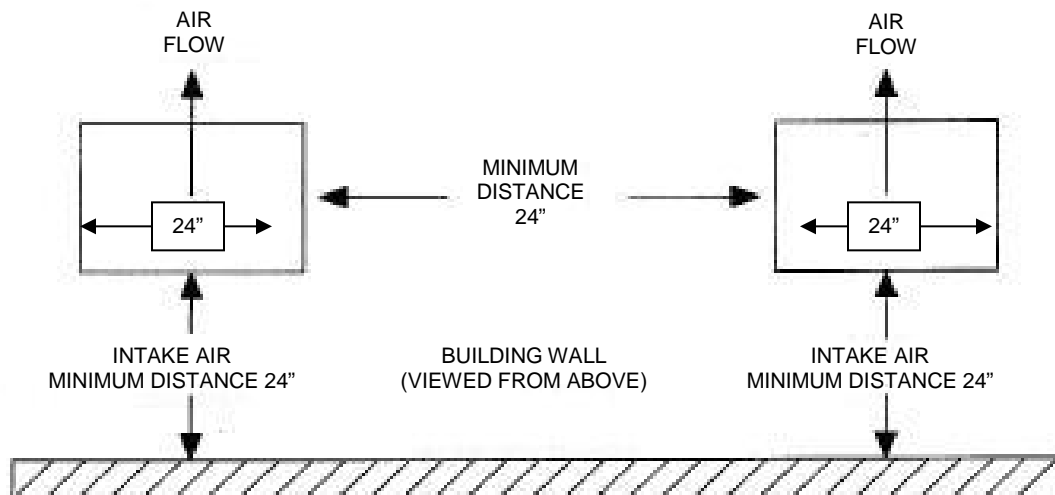

⚠ CAUTION

Failure to observe clearance and air flow requirements will result in poor system performance and premature equipment failure!

Locating and Mounting Evaporator Coil

General Guidelines

- Do not place the evaporator above or close to door openings. This will help prevent potential icing problems.
- Allow a minimum clearance equal to or greater than the coil height on all sides of the coil for proper air flow and service access.

General Guidelines - Locating and Mounting Evaporator Coil (continued):

- Use the evaporator coil for a template to locate and drill the mounting holes (1/2" diameter).
- Place a 1" and a 1-5/8" washer on each nylon bolt and insert through the drilled mounting holes in the ceiling from the exterior of the walk-in ceiling panel.

NOTE: Nylon bolts are supplied to prevent thermal transfer between the exterior of the walk-in and the interior of the walk-in. Do not use metal bolts.

- Lift the evaporator coil until the nylon bolts extend through the mounting brackets.
- Install washers and secure with nuts. Tighten until the coil is firm against the ceiling. The evaporator coil must be level.
- Additional information is available in the installation manual supplied with the evaporator.

CAUTION

Failure to observe clearance and air flow requirements will result in poor system performance and premature equipment failure!

Evaporator Coil Mounting Diagram

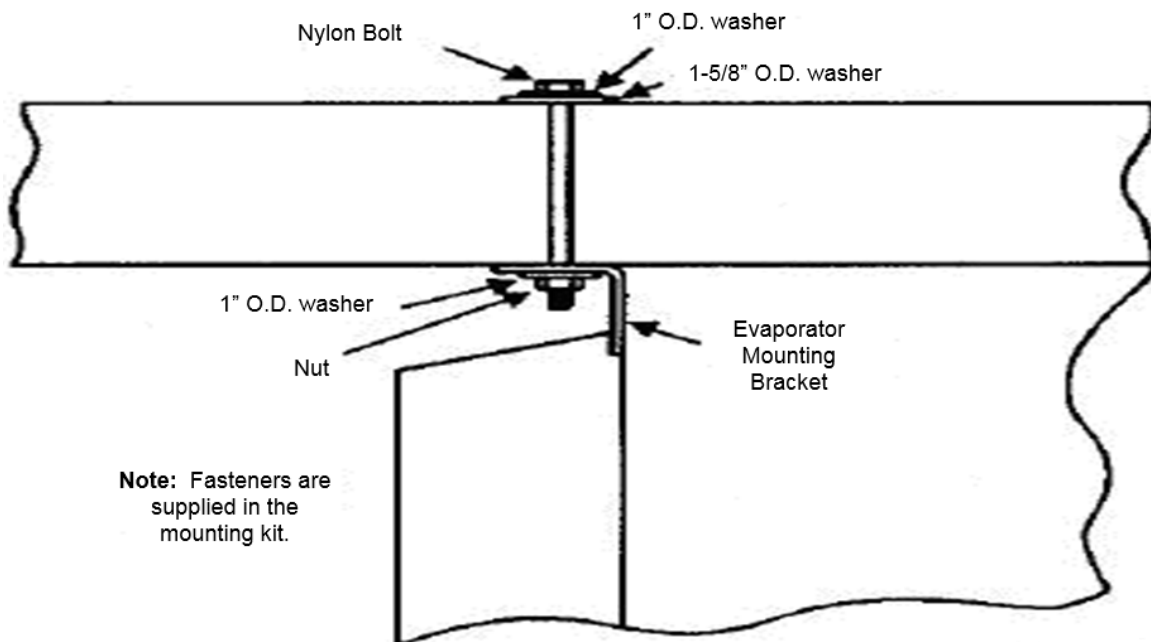

Wiring

All electrical connections and routing must comply with local and national codes. Do not modify the factory installed wiring without written factory approval. The field wiring must enter through the knockouts provided. Refer to the nameplate on the condensing or evaporator coil to determine the proper electrical power supply. Wire type should be of copper conductor only and properly sized to handle the electrical load. The unit and coil must be properly grounded. Condensing unit wiring diagrams are located inside this installation manual and attached inside the electrical box cover. Evaporator coil wiring diagrams are located inside this installation manual and inside the evaporator cover.

WARNING

All wiring must comply with local and national codes. Wiring must be performed only by a refrigeration technician or certified electrician. Failure to follow these guidelines may result in injury!

CAUTION

Check all wiring connections, including factory terminals, before operation. Connections can become loose during shipment and installation.

Piping

General Requirements

All refrigeration piping and components are to be installed in accordance with applicable local and national codes and in conformance with industry refrigeration guidelines to ensure proper operation of the refrigeration system. Only refrigeration grade copper tubing should be used. Long radius elbows should be used. Short radius elbows have points of excessive stress concentration and are subject to breaking at these points, do not use short radius elbows. Suction lines must be insulated with a minimum ¾" thick insulation tubing to reduce heat pick-up.

Cleanliness

Condensing units and evaporator coils are cleaned and dehydrated at the factory. The condensing unit must remain closed and pressurized until the piping is complete and final connections are ready to be made.

CAUTION

The maximum air exposure for dehydrated condensing units is 15 minutes. Systems exposed longer than 15 minutes must have the compressor oil and drier filter replaced. Leaving a system exposed to the atmosphere for more than 15 minutes can result in premature system failure.

Piping (continued):

Do not remove base mount valve covers until work is ready to be performed. Ensure that all refrigeration tubing is clean and dry prior to installation. Use only tubing cutters when trimming tubing to the proper length. Do not use saws to cut tubing.

CAUTION

The use of saws to cut tubing can contaminate the system with copper chips causing premature system failure.

Brazing joints require a dry inert gas, typically nitrogen, be passed through the lines at a low pressure to prevent scaling and oxidation. Use only silver solder brazing alloys. Minimize the amount of flux to prevent internal contamination. Flux only the male portion of the joint. Thoroughly clean fluxed joints after brazing.

CAUTION

Dry inert gas must be passed through the system while brazing to prevent scaling and oxidation. Scaling and oxides can clog refrigeration components resulting in system failure.

Pipe Supports

All tubing should be supported in a least two locations (near the end of each tubing run). Long runs will require additional support. As a guide, support 3/8" to 7/8" pipe every five feet, 1-1/8" to 1-3/8" every seven feet, and 1-5/8" to 2-1/8" every ten feet. Do not leave a corner unsupported when changing directions. Place supports within 2 feet of each direction change. Piping that is attached to a vibrating object (such as a compressor or compressor base) must be supported in a manner that will not restrict the movement of the vibrating object. Rigid mounting will fatigue the tubing causing refrigerant leaks.

Oil Traps

To ensure proper oil return to the compressor, a P-type oil trap should be installed at the base of each suction riser of four feet or more. The suction trap must be the same size as the suction line. Additional traps are necessary for long vertical risers. Add a trap for each length of pipe (approximately 20 feet) to insure proper oil return. Suction lines must slope 1/4" per 10 feet toward the compressor. Install a suction line trap at the evaporator outlet if the suction line rises to a point higher than the connection on the evaporator.

CAUTION

Failure to properly install oil traps can prevent sufficient oil return to the compressor resulting in premature compressor failure.

Pressure Regulating-Relief Valves

⚠ WARNING

Do not defeat, cap, add piping to the outlet of the valve, or, attempt to change the relief setting.

Drain Lines

Evaporator coil drain lines should be pitched a minimum of 1/2" per foot to allow proper drainage and exit the walk-in as quickly as possible. Insulate and seal the drain line where it passes through the wall. Copper drain line is required. Freezer compartment drain lines must have heat tape wrapped around the copper drain line and must have 3/4" thick insulation tubing. Do not locate drain line P-traps within the freezer space. Do not reduce the drain line size. Locate a drain line P-trap outside of the cooler space. Any outdoor P-traps exposed to low ambient temperatures should be wrapped with a drain line heater (provide 20 watts of heat per foot of drain line at 0°F, 30 watts per foot at -20°F). Freezer/cooler combo boxes can have one common drain line. However, there must be a P-trap located between the freezer evaporator and the cooler evaporator located inside the cooler compartment. The cooler compartment P-trap should be located between the cooler evaporator and the external drain location.

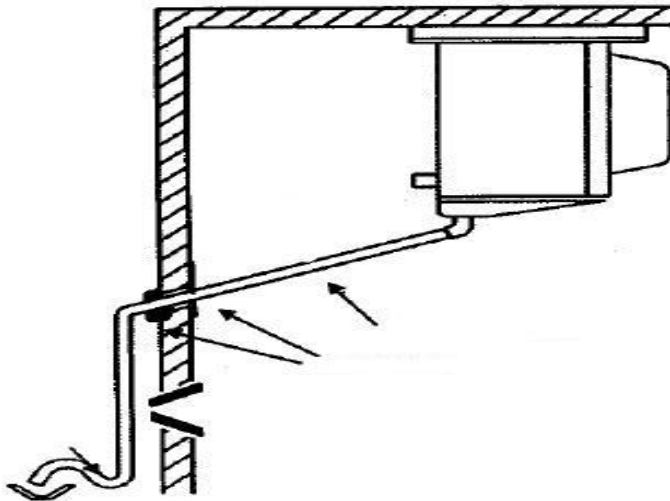

Pre-Charged lines and Quick Connects

Route the suction and liquid line sets between the condensing unit and evaporator coil following the piping guidelines identified in this manual. Remove the dust caps from the quick connect fittings and verify that the o-rings are intact. Wipe the coupling seals and threaded surfaces with a clean cloth to prevent contamination. Lubricate the threads and o-rings with Polyol Ester oil. Thread the coupling halves together by hand to ensure proper thread mating. Tighten with a wrench until the coupling bodies “bottom” or until there is definite resistance. Tighten an additional $\frac{1}{4}$ turn to ensure proper brass-to-brass seating. Once the system is opened and pressurized, check each fitting for refrigerant leaks. If a leak is detected, tighten until the leak stops.

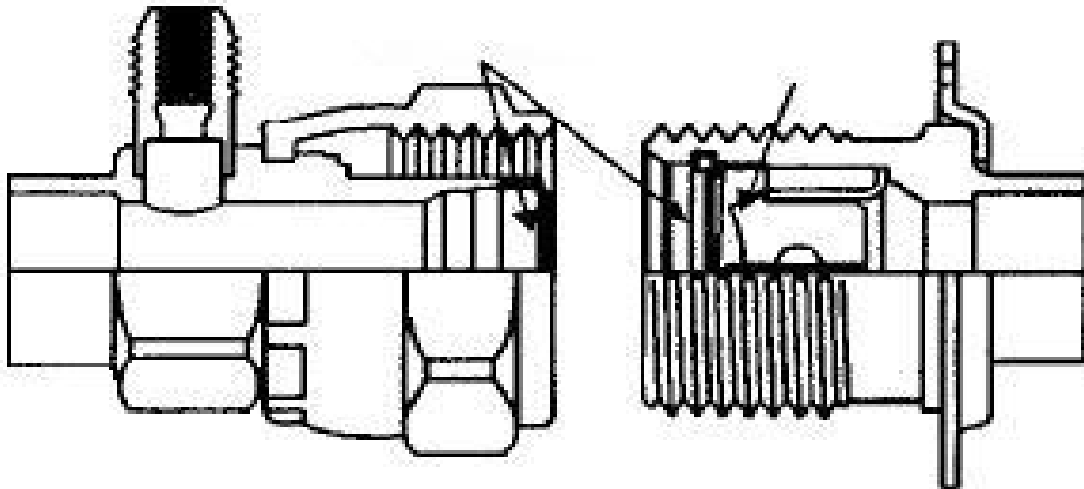

INCORRECT



CORRECT

WARNING

Do not loosen and disconnect the quick connect fittings before reclaiming the refrigerant and depressurizing the system. Disconnecting a pressurized system can result in injury!

Pre-Charged lines and Quick Connects (continued):

⚠ CAUTION

Quick connects are for one time use only. Once disconnected, the coupling cannot be re-used. Refrigerant leaks will occur if the couplings are re-used resulting in poor system performance.

Excess line set length should never be allowed to coil in the vertical position. Excess line length should be laid flat on its side.



INCORRECT



CORRECT

Leak Testing

After all connections are complete the refrigeration system must be tested for leaks. Failure to perform a leak test can result in unsatisfactory system performance, additional servicing and service costs, and possible system failure. Leak test should be performed using an electronic leak detector. All joints and components, both factory and field installed, should be thoroughly inspected for leaks. The system installation must be leak free!

Leak Testing “PR” model systems

- Open both the liquid and suction service valves.
- Ensure the solenoid valve is energized and open.
- Add 50 psi refrigerant, then pressurize with dry nitrogen to the low side test pressure identified on the unit rating label.
- Allow thirty minutes for refrigerant to reach all parts of the system.
- Check all joints and components with an electronic leak detector.

Leak Testing “PC” model systems

- Leave the service valves closed, the condensing unit is charged with refrigerant.
- Ensure the solenoid valve is energized and open.
- Add 50 psi refrigerant, then pressurize with dry nitrogen to the low side test pressure identified on the unit rating label.
- Allow thirty minutes for refrigerant to reach all parts of the system.
- Check all joints and components with an electronic leak detector.

Leak Testing “PCL” model systems

- Open both the liquid and suction service valves.
- Ensure the solenoid valve is energized and open.
- Allow thirty minutes for refrigerant to reach all parts of the system.
- Check all joints and components with an electronic leak detector.

If a leak is detected, relieve the pressure and/or reclaim the refrigerant and repair the leak. If additional brazing is required, pass a dry inert gas (nitrogen) through the system to prevent contamination. Reference page 12 of this manual for leaks located at quick connects couplings. Retest the system as outlined above until no leaks are detected.

CAUTION

If a braze joint is detected leaking, dry inert gas must be passed through the system while repairing the joint to prevent scaling and oxidation. Scaling and oxides can clog refrigeration components resulting in system failure.

CAUTION

Always use the system specified refrigerant when pressuring to perform a leak test.

System Evacuation

Evacuation of the refrigeration system is necessary to remove all air and moisture from the system. A reliable rotary vacuum pump with an accurate deep vacuum gauge is recommended. Do not use the system compressor as a vacuum pump and do not operate the compressor while the system is under vacuum.

Evacuation of “PR” model systems

- Open both the liquid and suction service valves.
- Ensure the solenoid valve is energized and open.
- Connect vacuum pump to the liquid and suction service valves located on the condensing unit.
- Evacuate the system to 250 microns and maintain for a minimum of 4 hours.
- Perform a vacuum decay test for a minimum of ten minutes to ensure the system is leak free and dry.

Evacuation of “PC” model systems

- Leave the service valves closed, the condensing unit has been evacuated and is charged with refrigerant.
- Ensure the solenoid valve is energized and open.
- Connect vacuum pump to the liquid and suction service valves. located on the condensing unit.
- Evacuate the system to 250 microns and maintain for a minimum of 4 hours.
- Perform a vacuum decay test for a minimum of ten minutes to ensure the system is leak free and dry.

Evacuation of “PCL” model systems

- “PCL” systems do not require evacuation.

CAUTION

Do not use the system compressor to evacuate the system. Do not start the compressor while the system is under vacuum. This may damage to the compressor and cause premature system failure.

Refrigerant Charging

- The refrigerant charge should be added to the system through the liquid line service valve located on the condensing unit. Do not charge liquid refrigerant into the suction service valve! The initial charge should be determined by weight and sight glass indication. Start the system. If the condensing temperature is 105° F or greater, charge the system until the sight glass clears. If the condensing unit temperature is below 105° F, reduce the condenser face surface area to raise the discharge pressures above 105° F and to charge to a clear sight glass. Return to a full condenser face area when charging is complete.

NOTE: PC & PCL refrigerant charge amounts are based on average ambient operating temperatures across the United States. Any refrigerant amount added or removed based on ambient operating temperatures is considered part of normal maintenance and is not covered under warranty.

CAUTION

Do not charge liquid refrigerant into the suction service valve located on the condensing unit. Do not overcharge the system. These conditions can permit liquid refrigerant to enter the compressor and cause damage to internal components resulting in premature system failure.

Operational Start-Up

The first 2 – 4 hours of operation after initial start-up is a critical time. Do not just start the system and leave. Pressure values, compressor and evaporator superheat, and inspecting for excessive vibrations and loose connections are some of checks that must be performed prior to leaving the system.

Pre-Start Checks

- Verify that all service valves are fully open.
- Ensure that all refrigerant and electrical connections are tight.
- Verify that the wiring and piping is properly routed and secured.
- The compressor mounting bolts are properly adjusted (see compressor mounts on page 18).
- All fan motors and mounting brackets are tight.
- The condensing unit base and evaporator coil are properly secured.

Compressor Mounts

Hermetic Compressors – hermetic compressor springs are mounted internally; check the compressor mounting bolts to ensure the nuts have not become loose during shipment.

Semi-Hermetic Compressors – most semi-hermetic compressors have external spring mounts and are factory assembled. The following actions are required once the condensing unit is installed and before system start-up:

- Loosen the upper mounting nuts.
- Remove the spring steel clips from the mounting springs.
- Retighten the upper mounting nuts until the compressor can float on the springs approximately 1/16" between the mounting nut and rubber grommet.

Compressor Mounts (continued)

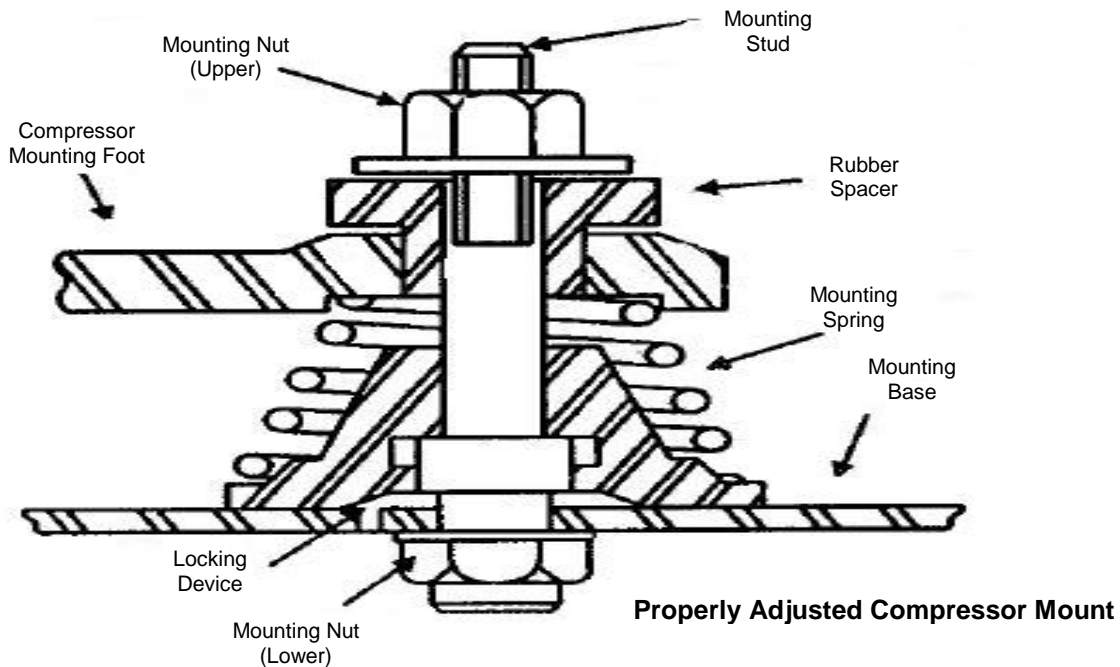

⚠ CAUTION

Failure to ensure the compressor mounts are properly tightened can result in fatigue to the system piping causing leaks and poor system performance.

Start-Up Procedure

⚠ CAUTION

Do not start the system while in a vacuum. Do not leave the system unattended until normal operating conditions are achieved.

Operate the system for a minimum of two hours and perform checks of the following:

- Check the compressor discharge and suction pressures to ensure they are in the normal operating range.
- Check the liquid line sight glass for proper refrigerant charge (based off of 105°F condenser coil).

Monitor the compressor oil level (semi-hermetic compressors), add oil as necessary to keep the level at $\frac{3}{4}$ sight glass when idle and $\frac{1}{2}$ sight glass when running.

- Check the voltage and amperage at the compressor terminals. Voltage must be within +10% or -5% of the rating indicated on the condensing unit name plate. On three phase compressors, verify there is a balanced load.

Start-Up Procedure (continued):

- Check all fans on the evaporator coil and condensing unit to be sure they are operational and turning in the correct direction.
- Check the piping and electrical connections for vibration. Add supports and strapping if needed.
- Check the crankcase heater operation (if equipped).
- Set the defrost control time and verify the defrost initiation settings. See pages 28-30 for additional details.
- Set temperature control to desired temperature range.
- Check the compressor and evaporator superheat (reference pages 21-23).

After all system checks have been checked, properly adjusted, and verified, replace all Schrader caps, service valve caps, electrical box covers, housings, etc. File a copy of this manual for future reference.

CAUTION

Failure to check and properly adjust compressor superheat can result in premature system failure.

Compressor Superheat

Compressor superheat is a critical value that must be checked. Check the compressor superheat as follows:

1. Determine the suction pressure at the suction service valve of the compressor.
2. Determine the saturation temperature at the observed suction pressure using refrigeration pressure temperature tables.
3. Measure the suction line temperature 6 -10 inches away from the compressor.
4. Subtract the saturation temperature (step 2) from the measured temperature (step 3). The difference is the superheat of suction gas.

A low suction superheat can cause liquid to return to the compressor. This will cause dilution of the oil and eventual failure of the bearings, rings and valves. A high suction superheat will cause excessive discharge temperatures, which cause a breakdown of the oil. This causes piston ring wear, and piston and cylinder wall damage. System capacity decreases as the suction superheat increases. For maximum system capacity, keep the suction superheat as low as practical. Copeland requires a minimum compressor superheat of 20°F; however, to improve compressor life, 25°F to 40°F is preferred. Adjust the expansion valve at the evaporator when adjustments to the suction superheat are necessary. Refer to “Evaporator Superheat” on the next 2 pages for more information.

CHECK THE TEMPERATURE AND PRESSURE, THEN CONSULT A PRESSURE/TEMPERATURE CHART.

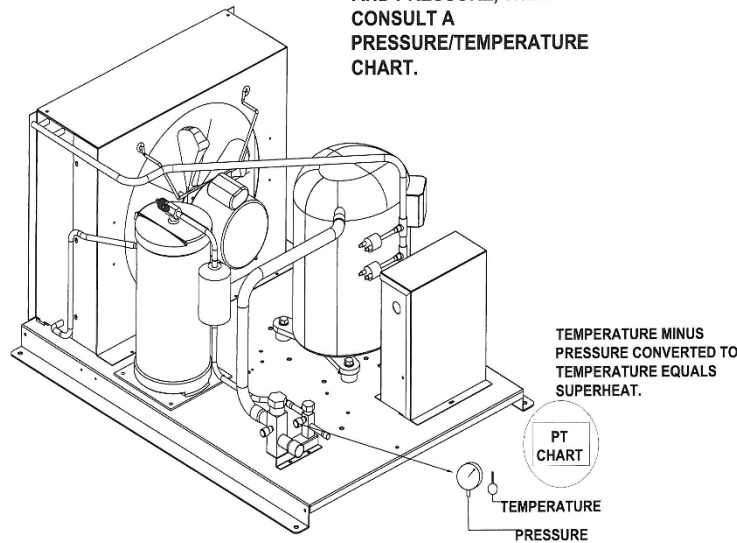

DETERMINING COMPRESSOR SUPERHEAT

Evaporator Superheat

Check the evaporator superheat once the walk-in has reached the desired temperature. Generally, systems with a design temperature drop of 10°F should have an evaporator superheat value of 6°-10°F on freezers and 8°-12°F on coolers for maximum efficiency.

To determine the evaporator superheat:

1. Measure the suction pressure at the evaporator outlet.
2. Convert the pressure to saturation temperature referencing a temperature-pressure chart.
3. Measure the temperature of the suction line at the expansion valve bulb. Ensure the bulb is mounted at the correct location on the suction tube.
4. Subtract the saturation temperature reading (step 2) from the measured temperature (step 3). The difference is the evaporator superheat.

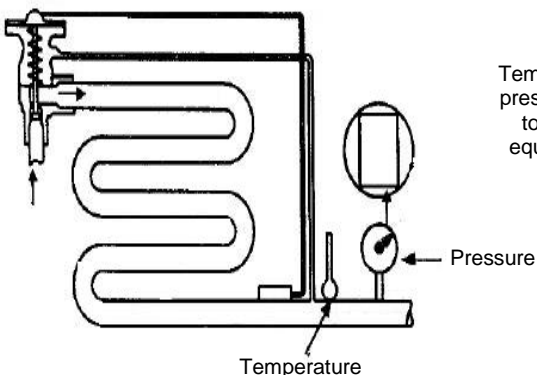

Temperature minus pressure converted to temperature equals superheat

BULB AND CONTACT LOCATION

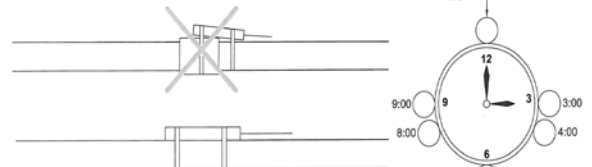

THE BULB SHOULD NEVER BE PLACED ON A COUPLING OR OTHER OBSTRUCTION SO AS TO NOT MAKE 100% CONTACT WITH THE SUCTION LINE. THE BULB SHOULD ALSO NEVER BE PLACED ON A TRAP, OR DOWNSTREAM OF A TRAP IN THE SUCTION LINE. LOCATING THE BULB AT THE TOP OR BOTTOM OF THE SUCTION LINE IS NOT RECOMMENDED. THE BULB SHOULD BE LOCATED AT THE 3:00, 4:00, 8:00 OR 9:00 POSITION ON THE SUCTION LINE.

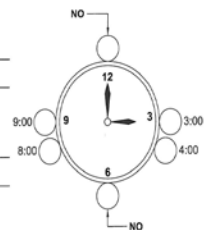

⚠ CAUTION

Minimum compressor superheat of 20°F may override these recommendations on systems with short line runs.

⚠ CAUTION

The condensing unit must have the discharge pressure above the equivalent 105°F condensing pressure (reference refrigerant charging on page 16).

⚠ CAUTION

Correct location and full contact of the expansion valve bulb is extremely important for proper system performance.

Thermostats

P/N 550005663

Air Defrost Evaporators



P/N 550005664

Electric Defrost Evaporators











P/N 550005663 is used on all Air Defrost model evaporators and features a built in Air Defrost time clock. The default defrost settings are every 6 hours for 30 minutes. See pages 27-28 for default and custom defrost setting instructions.

P/N 550005664 is used on all Electric defrost model evaporators. See page 29 for Electric Defroster Timer setting instructions.

NOTE: The 550005664 display will be blank during the electric defrost cycle.

Thermostats (continued):

	Red Light - Not used
	Yellow Light - Non-critical alarm (system running)
	Green Light - System running
	Green Flashing - System waiting on minimum on/off timer to start/stop

- Access Setpoint mode by pressing and holding the **ENTER** button until ts (Temperature setpoint) displays on the screen
- Use the  up and  down arrows to scroll through the available setpoints
- Press **ENTER** to view the current setting
- Use the  up and  down arrows to change the setpoint
- Press and hold the **ENTER** button to confirm each setpoint change
- Press the **BACK** button to escape

Thermostats (continued):

Setpoints

tS = Temperature setpoint

diF = Differential

CSH = Maximum compressor starts/stops

dPd = Defrost per day

tod = time of day (only used when custom defrost is selected)

dFt = Defrost time

HAO = High Alarm Offset

LAO = Low Alarm Offset

tAd =Temperature Alarm Delay

Adr = Mod Bus Address

Unt = Ynits for temperature display (FAH or CEL)

Basic Setpoints

Setpoint	Description	Minimum	550005663	550005664	Maximum
			Default	Default	
tS	Temperature Setpoint	-50°F (-45°C)	35°F	10°F	100°F (38°C)
diF	Differential	1°F	3.5°F	3.5°F	30°F
CSH	Maximum Compressor Starts/Hour	5 (Off)*	0 (off)	0 (off)	10
dPd	Defrost Per Day	0	4	0	12, CUS**
dFt	Defrost Time	0 min	30 min	0 min	720 min
HAO	High Alarm Offset	1°F	10°F	10°F	10°F
LAO	Low Alarm Offset	1°F	5°F	5°F	10°F
tAd	Temp Alarm Delay	1 min	60 min	60 min	180 min
Adr	Mod Bus Address	1	1	1	247
Unt	Units for Temp Display	FAH	FAH	FAH	CEL

*Selecting fewer than 5 compressor starts per hour results in the starts per hour feature being turned off. The compressor will then function on temperature only.

** Selecting CUS (custom) unlocks 12 tod (time of day) defrost setpoints.

Thermostats (continued):

Custom tod (Time of Day) Defrost Setpoints

Setpoint	Description	Minimum	Default	Maximum
tod	Time of Day	0.0	12.0	23.5
d1	Start time of day #1	0.0	dis (disabled)	23,dis (disabled)
d2	Start time of day #2	0.0	dis	23,dis
d3	Start time of day #3	0.0	dis	23,dis
d4	Start time of day #4	0.0	dis	23,dis
d5	Start time of day #5	0.0	dis	23,dis
d6	Start time of day #6	0.0	dis	23,dis
d7	Start time of day #7	0.0	dis	23,dis
d8	Start time of day #8	0.0	dis	23,dis
d9	Start time of day #9	0.0	dis	23,dis
d10	Start time of day #10	0.0	dis	23,dis
d11	Start time of day #11	0.0	dis	23,dis
d12	Start time of day #12	0.0	dis	23,dis

Note: The time of day defrost setting use military time. The first 2 digits are the hour and the 1 digit after the decimal is the minutes.

Thermostats (continued):

Custom Defrost Setup

Custom Defrost Setup

The following steps will guide you through the setup of the custom defrost feature.

Abbreviations:

CUS = custom
d1 = custom defrost 1
dis = disabled
dpd = defrosts per day
ts = temperature setpoint
tod = time of day



STEP 1

Press and hold the **ENTER** button, ts is displayed on the LEDs



STEP 2

Press the **▲** up arrow until dpd is displayed,



then press **ENTER**, 6 (default) will be displayed.



STEP 3

Press the **▲** up arrow until CUS is displayed.



Press and hold the **ENTER** button for 3 seconds until the dpd is displayed.



STEP 4

Press the **▲** up arrow until tod (time of day) is displayed,



then press **ENTER**

Use the **▲** up arrow and **▼** down arrow to set the time.

Note: The time is displayed in military time (24-hr clock) The 1st 2 digits are the hour. The minutes are after the decimal. Since there are only 3 digits, the time will be set to the nearest 10 minutes. See examples below.

Examples:

8:10 am would be 8.1 on the controller's display



4:32 pm would be 16.3 on the controller's display.



After the time is set, press and hold the **ENTER** button for 3 seconds, until tod is displayed



STEP 5

Press the **▲** up arrow to display Defrost 1 (d1).



To set the first defrost, press **ENTER** button.

dis (disabled) will be displayed.



Use the **▼** down arrow to set the defrost time.

Note: Defrost times may only be set on the hour.

Example:

2:00 am would be 2



Once the correct time is displayed, press and hold the **ENTER** button until d1 is displayed.



STEP 6

Repeat steps as necessary for d2 to d12.



STEP 7

Press the **BACK** button to save settings, and return to the main screen (room temp will be displayed).

Electric Defrost Timer

ELECTRIC DEFROST TIMER

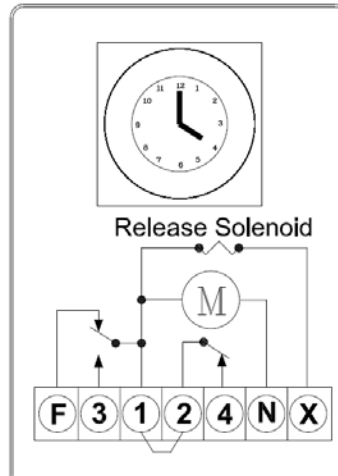

Electric Defrost Time Clock Instructions:

Instructions for setting the timer is located on the inside cover of the time clock. The defrost timer clock must be set to the correct time at initial start-up and after any power interruptions. Set the clock by rotating the clock face until the correct time is at the arrow on the face of the timer. The switch is programmed by pushing the captive trippers to the inner ring for the entire period the load is to be turned "ON". When a tripper is pushed to the outside, the switch is in the "DEFROST" position. Each defrost tripper represents 15 minutes of defrost time. The timer is factory set for four defrost cycles daily: 4:00AM, 10:00AM, 4:00PM, and 10:00PM. Each defrost cycle is programmed for 45 minutes duration. The defrost times may be changed to initiate at periods of low activity (trippers pushed out will close contacts to terminals 1 & 3).

Note: If the defrost termination thermostat fails to close, the fail safe setting on the timer will terminate the defrost cycle. The timer starts the defrost cycle automatically at the predetermined times. A setting of two to four defrost cycles per day is typical. For heavier frost loads, additional cycles may be required.

When the defrost cycle begins:

1. Switch 2 to 4 opens in the time clock, breaking the circuit to the room thermostat, liquid line solenoid, and evaporator fan motors. This allows the compressor to pump down and shut off. Simultaneously, switch 1 to 3 closes in the timer, energizing the defrost heaters.
2. The heaters increase the coil temperatures above 32°F, melting the frost off the coil.
3. When the coil warms to approximately 55°F, the defrost termination thermostat closes and energizes the switching solenoid in the timer. At this time, switch 1 to 3 in the timer opens, terminating the defrost heaters. Simultaneously, switch 2 to 4 closes in the time clock, energizing the temperature control circuit.
4. Suction pressure rises, the low pressure control closes, and the compressor starts.
5. The fan relay closes when the coil temperature reaches approximately 30°F. This energizes the fan motors.
6. The system operates in the refrigeration cycle until another defrost cycle is initiated by the timer.

Maintenance

Maintenance Chart

Area	Task	Frequency
Evaporator	Check for proper defrosting	Monthly
	Clean the coil and drain pan	Every 6 months
	Check for proper drainage	
Condenser	Inspect /clean the coil if the air supply is near polluting sources (such as cooking appliances)	Monthly
	Clean the coil surface	Every 3 months
General	Check/tighten all electrical connections	Every 6 months
	Check all wiring and insulators	
	Check contactor for proper operation and contact point deterioration	
	Check all fan motors	
	Tighten fan set screws, and motor mount nuts and bolts	
	For semi-hermetics, check the oil level in the system	
	Check the operation of the control system	
	Make certain all safety controls are operating properly	
	Check operation of the drain line heater and examine for cuts and abrasions	
	Check/tighten all mechanical/flare connections	

CAUTION

Failure to keep the condenser coil clean will result in reduced airflow through the condenser, resulting in poor system performance and premature compressor failure.

Polyol Ester (POE) Lubricants

Polyol Ester (POE) lubricants quickly absorb moisture from the ambient surroundings. POE lubricants absorb moisture more rapidly and in greater quantity than conventional mineral oils. Because moisture levels greater than 100 PPM will result in system corrosion and component failure, it is essential that system exposure to ambient conditions be kept to a minimum.

If a system is left open to the atmosphere for more than 15 minutes, the liquid line drier and compressor oil must be replaced. Drain at least 95% of the oil from the compressor suction port. Measure the amount of removed oil, and replace it with exactly the same amount of new POE oil. Mobil EAL™ ARCTIC 22 CC is the preferred Polyol Ester lubricant because of its particular additives. ICI Emkarate RL 32S is an acceptable alternative when the Mobil is not available. These POE lubricants must be used with HFC refrigerants. Lubricants are packaged in specially designed, sealed containers. Once opened, use the lubricant immediately. Properly dispose of any unused lubricant.

Troubleshooting Charts

Evaporator Troubleshooting Chart

Problem	Possible Cause	Corrective Action
Fan(s) will not operate.	Main switch open	Close switch
	Blown fuse(s)	Replace fuse(s). Check for short circuits or overload conditions.
	Defective motor	Replace motor.
	Defective timer or defrost thermostat	Replace defective component.
	Unit in defrost cycle	Wait for completion of cycle.
Walk-in temperature too high.	Thermostat set too high	Adjust thermostat.
	Superheat too high	Adjust thermal expansion valve.
	System low on refrigerant	Locate and repair leak, recover, evacuate and recharge.
	Coil iced up	Manually defrost coil. Check defrost controls.
Ice accumulating on ceiling around evaporator and/or on fan guards, venturi, or blades.	Defrost duration is too long	Adjust defrost termination thermostat (if adjustable).
	Fan delay not delaying fans after defrost period	Replace defective defrost thermostat.
	Defective defrost thermostat or timer	Replace defective component.
	Too many defrost cycles per day	Reduce number of defrost cycles per day.
Frost on coil after defrost cycle.	Coil temperature not getting above freezing point during defrost	Check heater operation
	Not enough defrost cycles per day	Adjust timer for more defrost cycles per day
	Defrost cycle too short	Adjust timer for longer cycle, check defrost thermostat mounting
	Defective timer or defrost thermostat	Replace defective component.
Ice accumulating in drain pan.	Defective heater	Replace heater.
	Unit not pitched properly	Check and adjust.
	Drain line plugged	Clean drain line.
	Defective drain line heater	Replace heater.
	Defective timer or thermostat	Replace defective component.

Condensing Unit Troubleshooting Chart

Problem	Possible Cause	Corrective Action
Compressor will not run.	Main switch open	Close switch
	Fuse blown	Check electrical circuits and motor winding for shorts or grounds. Investigate for possible overloading. Replace fuse after fault is corrected.
	Thermal overloads tripped	Overloads are automatically reset. Check unit closely when unit comes back on line.
	Defective contactor or coil	Repair or replace
	System shut down by safety devices	Determine type and cause of shutdown and correct
	No cooling required	None. Wait until cooling is required.
	Liquid line solenoid will not open.	Repair or replace coil.
	Low pressure switch will not close.	Replace switch
	Motor electrical trouble	Check motor for open windings or short circuit.
	Loose wiring	Check all wire junctions. Tighten all terminal screws.
Compressor noisy or vibrating	Flooding of refrigerant into crankcase	Check superheat setting of expansion valve
	Improper pipe support	Relocate or add hangers
	Worn compressor	Replace compressor
High discharge pressure	Non-condensable in system	Recover, evacuate and charge
	System overcharged with refrigerant	Remove excess charge
	Discharge shut-off valve partially closed	Open valve
	Fan not running	Check electrical circuit or replace defective fan motor
	Insufficient condenser air supply	Check for cause and correct
	Dirty condenser coil	Clean coil
Low discharge pressure	Faulty head pressure control	Check head pressure control operation.
	Suction shut-off valve partially closed	Open valve
	Insufficient refrigerant in system	Locate and repair leak, recover, evacuate and recharge
	Low suction pressure	Check for proper refrigerant charge

Condensing Unit Troubleshooting Chart (continued):

Problem	Possible Cause	Corrective Action
High suction pressure	Excessive load	Reduce load or add additional equipment
	Expansion valve overfeeding	Secure and insulate TXV bulb or if required adjust superheat.
Low suction pressure	Lack of refrigerant	Locate and repair leak, recover, evacuate and charge.
	Evaporator dirty or iced	Clean
	Clogged liquid line or suction line filter-drier	Replace filter-drier
	Expansion valve malfunctioning	Check and reset for proper superheat
	Condensing temperature too low	Check head pressure control
	Improper TXV	Check for proper sizing
Compressor loses oil	Lack of refrigerant	Locate and repair leak, recover, evacuate and recharge
	Excessive compression ring blow-by	Replace compressor
	Refrigerant flood back	Maintain proper superheat at compressor
	Improper piping or traps	Correct piping
Compressor thermal protector switch open	Operating beyond design	Add facilities so that operating conditions are within allowable limits
	Discharge valve partially shut	Open valve
	Dirty condenser coil	Clean coil
	Overcharged system	Correct charge

Notes:

System Start-up Checklist

Date System Installed: _____ / _____ / _____

Installer and Address: _____

Phone Number: (____) _____ - _____

Start-Up Service Agency: _____

Phone Number: (____) _____ - _____

Freezer Condensing Unit				
Inspection Feature	Data	Accept	Reject	Action Required
Model Number:				
Serial Number:				
Electrical Volts:				
Electrical Phase:				
Amperage @ L1:				
Amperage @ L2:				
Amperage @ L3:				
Ambient Temp:	°F			
Comp. Discharge Pressure:	PSIG			
Comp. Suction Pressure:	PSIG			
Suction Line Temp @ Comp.:	°F			
Discharge Line Temp @ Comp.:	°F			
Comp. Superheat:	°F			
Defrost Setting (4 day/45 min):				
All electrical connections are tight:				
Unit base properly supported:				
Fans Running & No Vibration:				
All guards, covers attached:				
Refrigerant Sight Glass Clear:				
Comp. Oil Level @ ½ Sight Glass:				
Comp. Mounting Clips Removed:				
Suction line insulated fully and properly supported:				

Freezer Evaporator				
Inspection Feature	Data	Accept	Reject	Action Required
Evaporator installed with nylon bolts with proper airflow clearance:				
Model Number:				
Serial Number:				
Electrical Volts:				
Electrical Phase:				
Suction Line Temp @ Evap:	°F			
Evap Superheat:	°F			
Thermostat Set:	°F			
Operating Temp:	°F			
TXV Bulb Properly Mounted:				
All guards, covers attached:				
All electrical connections are tight:				
Defrost Heater Amp Draw:	A			

Freezer Piping				
Inspection Feature	Data	Accept	Reject	Action Required
Suction Lines Insulated:				
Oil Trap at Base of Suction Riser:				
Copper Drain Lines Sloped Min 1/2" ft:				
Piping Supported Every 5':				
Copper drain line heater attached, working, and insulated:				
Copper Drain Line Trapped Outside Freezer Space:				

Cooler Condensing Unit				
Inspection Feature	Data	Accept	Reject	Action Required
Model Number:				
Serial Number:				
Electrical Volts:				
Electrical Phase:				
Amperage @ L1:				
Amperage @ L2:				
Amperage @ L3:				
Ambient Temp:	°F			
Comp. Discharge Pressure:	PSIG			
Comp. Suction Pressure:	PSIG			
Suction Line Temp @ Comp.:	°F			
Discharge Line Temp @ Comp.:	°F			
Comp. Superheat:	°F			
Defrost Setting (4 day/45 min):				
All electrical connections are tight:				
Unit base properly supported:				
Fans Running & No Vibration:				
All guards, covers attached:				
Refrigerant Sight Glass Clear:				
Comp. Oil Level @ 1/2 Sight Glass:				
Comp. Mounting Clips Removed:				
Suction line insulated fully and properly supported:				

Cooler Evaporator				
Inspection Feature	Data	Accept	Reject	Action Required
Evaporator installed with nylon bolts with proper airflow clearance:				
Model Number:				
Serial Number:				
Electrical Volts:				
Electrical Phase:				
Suction Line Temp @ Evap:	°F			
Evap Superheat:	°F			
Thermostat Set:	°F			
Operating Temp:	°F			
TXV Bulb Properly Mounted:				
All guards, covers attached:				
All electrical connections are tight:				

Cooler Piping				
Inspection Feature	Data	Accept	Reject	Action Required
Suction Lines Insulated:				
Oil Trap at Base of Suction Riser:				
Copper Drain Lines Sloped Min 1/2" ft:				
Copper Drain Lines Insulated:				
Copper Piping Supported Every 5':				
Copper Drain Line Trapped Outside Cooler Space:				

Walk-In Freezer				
Inspection Feature	Data	Accept	Reject	Action Required
Serial Number:				
Interior Lights Installed and Working:				
All Penetrations Sealed:				
Doors/Jambs Squared and Operating Properly:				
All Panel Locks Fully Engaged:				
All Plug Buttons Installed:				
Door Heater Working:				
Door Sweeps Adjusted:				
Heat Air Vent Working:				
Door Closers Adjusted and Working:				
Wainscot and Trim Installed:				
Alarm Set and Working:				
Thermometer Bulb Mounted and Calibrated:				
Walk-In Clean (no excessive caulk, etc.)				
Walk-in at proper temperature:				

Walk-In Cooler				
Inspection Feature	Data	Accept	Reject	Action Required
Serial Number:				
Interior Lights Installed and Working:				
All Penetration Sealed:				
Doors/Jambs Squared and Operating Properly:				
All Panel Locks Fully Engaged:				
All Plug Buttons Installed:				
Door Heater Working:				
Door Sweeps Adjusted:				
Heat Air Vent Working:				
Door Closers Adjusted and Working:				

Wainscot and Trim Installed:				
Alarm Set and Working:				
Thermometer Bulb Mounted and Calibrated:				
Walk-In Clean (no excessive caulk, etc.)				
Walk-in at proper temperature:				

Notes:

Superintendent/Customer Signature: _____

Date: _____

Service Tech/Installer Signature: _____

Date: _____

Warranty Information

For information regarding warranty guidelines, claim form, product registration, warranty verification, or locating a service provider please visit our website at www.kolpak.com or call 1-800-225-9916.

Failure to follow the System Start-Up Checklist could create warranty issues in the future. Please follow, complete and return completed System Start Up Checklist forms to: KPR-Warranty@welbilt.com or fax to 1-731-847-5389.

This Page Intentionally Left Blank