



evō+

HIGH-WALL DUCTLESS AIR CONDITIONING & HEATING SYSTEM

Models:

GWH09AB-A3DNA2B

GWH12AB-A3DNA2B

GWH09AB-D3DNA2D

GWH12AB-D3DNA2D

GWH18AC-D3DNA2D

GWH24AC-D3DNA2D



Thank you for choosing an evō+ High-Wall Ductless Air Conditioning & Heating System!

You can feel confident in your selection because the same pride in craftsmanship and engineering knowledge that goes into millions of other Gree installed products worldwide has gone into your unit.

Please read this owner's manual carefully before operation and retain it for future reference.

Contents

- ***Safety Precautions*** **2**
- ***Part Names*** **4**
- ***Operation of Wireless Remote Controller*** **5**
- ***System Functions*** **16**
- ***Cleaning and Caring for Your Unit*** **17**
- ***Troubleshooting*** **19**
- ***System Operations/Energy Saving Tips*** **21**
- ***Warranty*** **Back**



SAFETY PRECAUTIONS

Please read the following before operation.

Recognize safety information.  This is the safety-alert symbol. When you see this symbol on the unit and in instructions or manuals, be alert to the potential for personal injury. Understand these signal words: **DANGER**, **WARNING**, and **CAUTION**. These words are used with the safety-alert symbol.

DANGER identifies the most serious hazards which will result in severe personal injury or death.

WARNING signifies hazards which could result in personal injury or death.

CAUTION is used to identify unsafe practices which may result in minor personal injury or product and property damage.

NOTE is used to highlight suggestions which will result in enhanced installation, reliability, or operation.

NOTE: Your actual air conditioning & heating system and related devices may differ from the images shown in this manual.

This appliance is not intended for use by children without responsible adult supervision. Proper care should be taken to ensure safety.

WARNING

Heat pumps, air conditioners & heating equipment should be installed, started up, and serviced only by qualified installers and service technicians. Air conditioning, heat pumps and refrigeration systems are hazardous due to high voltage electrical components, high refrigerant pressures, and moving parts.

SAFETY PRECAUTIONS

Please read the following before operation.

WARNING





- *Disconnect electrical power to the evō+ system before performing any maintenance or cleaning.*
- *Do not attempt to repair the evō+ system yourself. Incorrect repairs may cause electric shock or fire. Contact a qualified service technician for all service requirements.*
- *Do not splice the power cord or use an extension cord. Overheating can occur, causing a fire hazard.*
- *Keep combustible materials away from the unit.*

CAUTION

- *Do not put hands or any objects into the air inlets or outlets. This may cause personal injury or damage the unit.*
- *When cleaning, be careful not to splash water on the unit. Doing this may cause electric shock or damage to unit.*



Icons Displayed

	: COOL
	: DRY
	: HEAT
	: POWER
88	: SET TEMP

Front Panel Display

The front panel on the evō+ indoor unit contains system status lights and an easy-to-read LED display.

NOTE: *The indoor unit display panel can be turned ON or OFF via the LIGHT button on the remote controller. See "LIGHT" button description for more detail.*

PART NAMES

Indoor unit

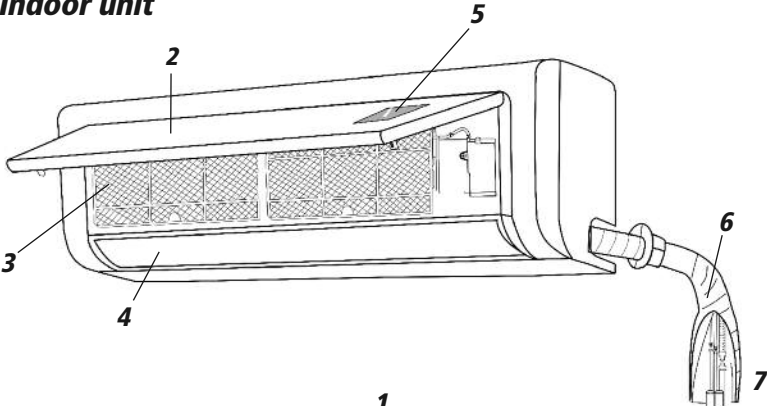

Part Name

- 1. Remote Controller
- 2. Front Panel
- 3. Filter
- 4. Swing Louvers
- 5. Remote Receiver Sensor
- 6. Refrigerant Pipes
- 7. Insulation
- 8. Refrigerant Pipes
- 9. Drain Hose



Outdoor unit

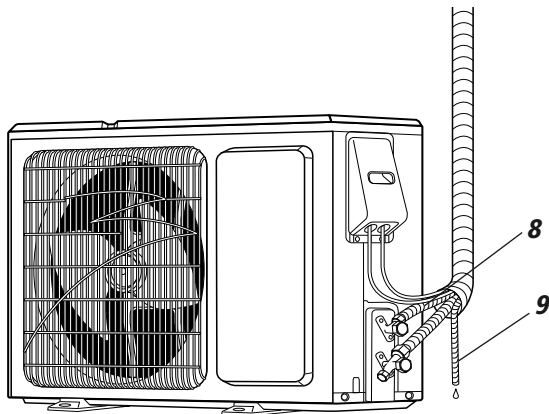

OPERATION OF WIRELESS REMOTE CONTROLLER

REMOTE CONTROLLER OPERATIONS

The evo+ universal wireless remote controller is sleek, versatile and allows you to change room temperatures and functions on unit from the palm of your hand. The large LCD display and buttons make it easy-to-understand and easy-to-use.

The remote controller may be used for several evo+ units. It can operate the unit from a distance of up to 25 ft. (7.6 m) as long as there are no obstructions. This is one-way communication only (from remote controller to indoor unit.)

The remote controller is set from factory to display temperatures in °F. If °C is desired, turn the remote **OFF** and then press "**MODE**" and "—" buttons on the remote simultaneously.

NOTE: Not every unit has each of the functions described below. If your unit does not come equipped with a certain function, the button will be inactive.

ON/OFF Button

- Pressing this button will turn the unit on and off. Using the **ON/OFF** function will cancel **TIMER** and **SLEEP** functions, but preset times will not be affected.

MODE Button

- Pressing this button will present the **AUTO**, **COOL**, **DRY**, **FAN** and **HEAT** mode options which can then be selected. **AUTO** mode is the default mode. When the indoor unit first powers on under this mode, the temperature will not be displayed.

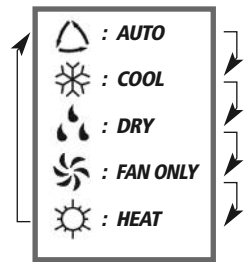

Icons Displayed

FAN Button

- Pressing this button will present the **AUTO**, **LOW**, **MEDIUM**, and **HIGH** speed options which can then be selected. • Low  • Medium  • High 

NOTE: When the indoor unit first powers on, the **AUTO** fan speed is the default mode. In **DRY MODE**, the fan will automatically run at low speed.



CAUTION

- Do not drop or throw remote controller.
- Protect remote controller from water
- Keep remote controller away from direct sunlight or high heat.

OPERATION OF WIRELESS REMOTE CONTROLLER



OPERATION OF WIRELESS REMOTE CONTROLLER

REMOTE CONTROLLER FUNCTIONS

CLOCK Button

- Press the **CLOCK**  button to enter Clock Setup Mode. The clock icon will begin flashing. Set the clock by pressing the + or - buttons. Press once for slow adjustment; press and hold down for fast adjustment. When finished, press the **CLOCK** button to save your clock settings. Note that this is the current time, not the timer setting.

NOTE: The clock panel on the remote controller will display the time regardless of whether the unit is **ON** or **OFF**.

LIGHT Button

- Press the **LIGHT** button to turn On or Off the display on the indoor unit front panel. When the indoor unit first powers on, the front panel display will default to **ON**. The **LIGHT**  icon will display when the front panel display is **ON**.

TURBO Button

- Press the **TURBO** button to reach the desired room temperature faster. After selecting the "**HEAT**" or "**COOL**" mode button, push the "**TURBO**" button. This will force the unit to run at ultra high speed. When **TURBO** mode is running, the **TURBO**  icon is displayed on the remote controller.

X-FAN Button

- Press the **X-FAN** button to allow the indoor fan to run for 10 minutes after the unit is turned off (cooling or dry modes only) to ensure that additional moisture is removed from coil. **X-FAN**  icon will be displayed on remote controller.

+ Button

- Press the + button to raise the room setpoint. Press once for slow adjustment and hold down for fast adjustment.

- Button

- Press the - button to lower the room setpoint. Press once for slow adjustment and hold down for fast adjustment.

OPERATION OF WIRELESS REMOTE CONTROLLER

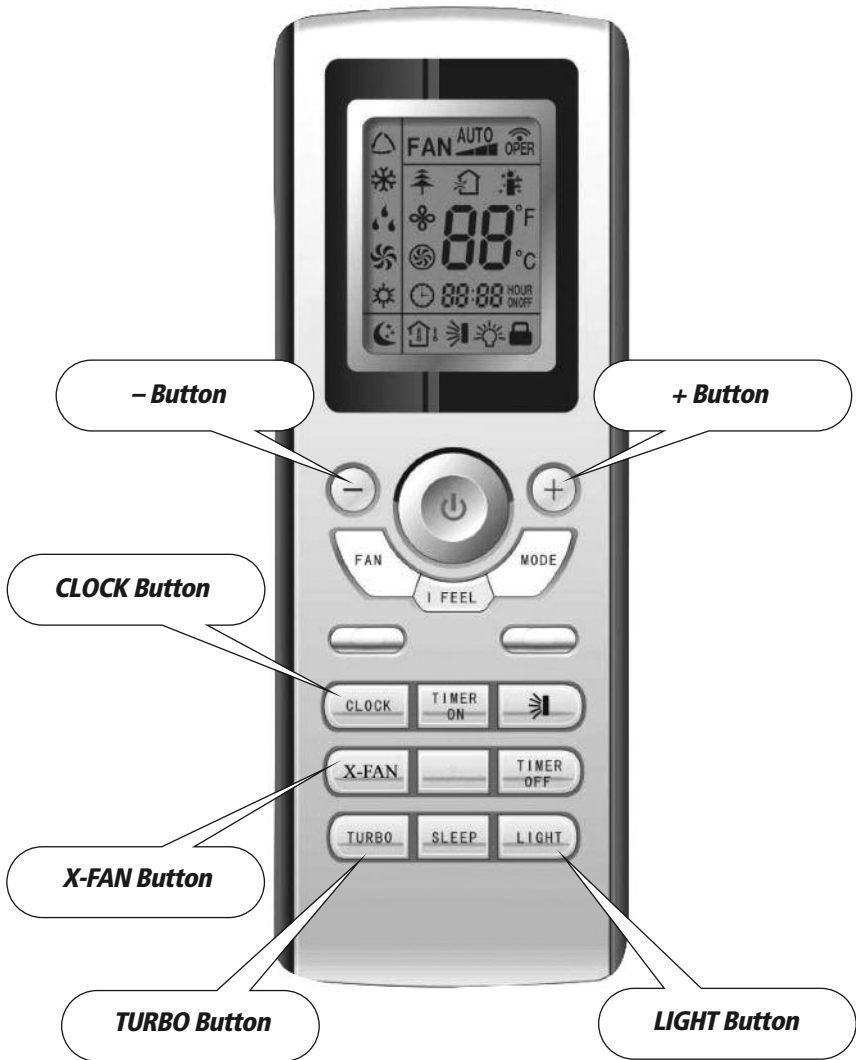

OPERATION OF WIRELESS REMOTE CONTROLLER

TIMER ON Button

- Press the **TIMER ON** button to enter **TIMER** mode. The **TIMER ON** icon will begin flashing. Set the time period when the unit will turn on by pressing the + or - buttons. Press once for slow adjustment and hold down for fast adjustment.

TIMER OFF Button

- Press the **TIMER OFF** button to enter **TIMER** mode. The **TIMER OFF** icon will begin flashing. Set the time period when the unit will turn off by pressing the + or - buttons. Press once for slow adjustment and hold down for fast adjustment.

I FEEL Button

- Press this button to turn on the **I FEEL** function. In this mode, the **I FEEL**  icon will turn on and room temperature is sensed at the remote controller for the ultimate in comfort control.

SLEEP Button

- Press the **SLEEP** button to activate **SLEEP** function and select one of three comfortable **SLEEP** modes. The **SLEEP**  icon will be displayed.

VERTICAL SWING LOUVER

- Press the  button to adjust the direction of airflow in the room. By moving the louvers up or down, you can control the air for maximum comfort.

OPERATION OF WIRELESS REMOTE CONTROLLER

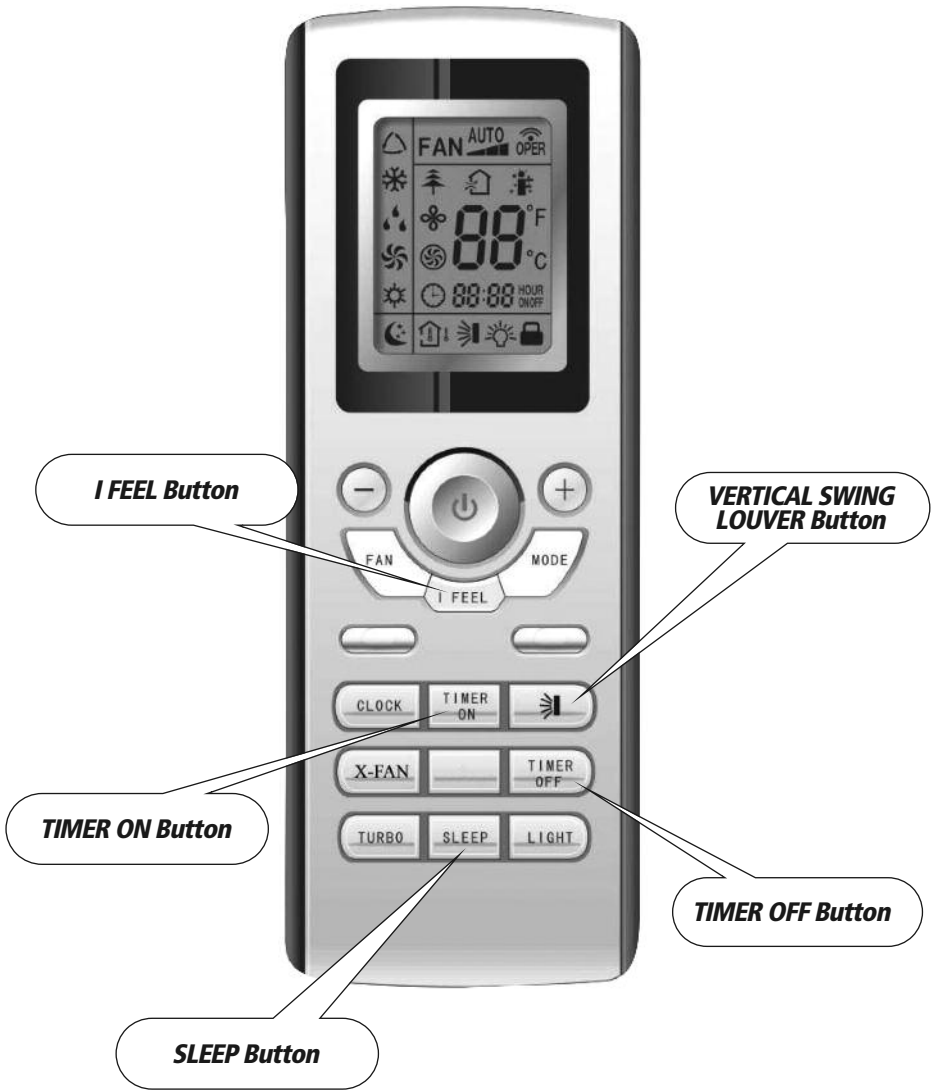

OPERATION OF WIRELESS REMOTE CONTROLLER

The wireless remote controller is the interface between the user and the evō+ system. Commands are entered by the user to control the system. Any command that has been entered with the remote controller will remain in memory until it is changed by the user or the batteries are replaced.

When entering commands, point the remote controller in the direction of the LED display on the front panel. The  indicator will appear for a short period of time on the remote controller when the command is entered. The unit will emit an audible beep when the signals are received correctly.

ON/OFF BUTTON

When the system is in **OFF** mode, the remote controller will display the time and last room setpoint. When you press the **ON/OFF** button, the unit will start in the last operating mode and room setpoint.

NOTE: If the **ON/OFF** button is pressed too soon after a stop, the compressor will not start for 3 minutes due to the inherent protection against frequent compressor cycling.



ON Mode Display

PRIVACY LOCK MODE

The Privacy Lock prevents unauthorized access to the unit controls and prevents tampering with system settings. The remote controller can be locked by pushing the "+" and "-" buttons simultaneously for 2 seconds. The Privacy Lock icon will be displayed on the remote controller. Repeat the process to unlock the remote controller.



Privacy Lock Display

OPERATION OF WIRELESS REMOTE CONTROLLER

MODE BUTTON

Use the "**MODE**" button to select one of the available modes. The selected mode will be displayed on the remote controller and the appropriate light will illuminate on the display panel.

AUTO – Unit will automatically select heating or cooling to maintain room temperature between 68°F and 77°F. The remote controller will display the Auto Mode icon with no setpoint. The front panel display will show "77."

COOL – To cool to selected setpoint and remove moisture. System varies compressor speed to maintain desired temperature.

HEAT – To heat to selected room setpoint. System varies compressor speed to maintain desired room temperature.

FAN ONLY – To circulate air without heating or cooling. Use Fan Speed button to select speed from low to high.

DRY – Select **DRY MODE** to increase moisture removal during warm humid conditions.

1. Room Temperature > Setpoint +4°F, the system will be operating in cooling mode with low fan speed.
2. Setpoint -4°F, < Room Temperature < Setpoint +4°F, the system will cycle 6 minutes **ON** and 4 minutes **OFF** in cooling mode. The indoor fan will be at low speed.
3. Room Temperature < Setpoint -4°F, the system will be **OFF** and the indoor fan will be at low speed.

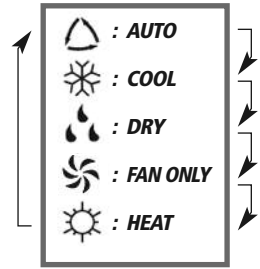

Icons Displayed

OPERATION OF WIRELESS REMOTE CONTROLLER

VERTICAL SWING LOUVERS

- Press the Vertical Swing Louver button to select five different vertical (up & down) air discharge directions including Continuous Sweep. The Vertical Swing Louver icon will be displayed. Press this button to set swing angle, which circularly changes as below:

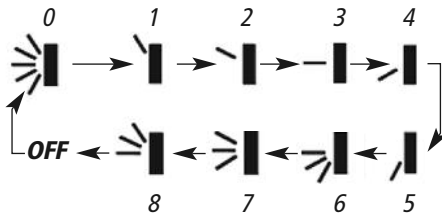

Indicates louver swings back and forth in the five places, as shown in the figure.

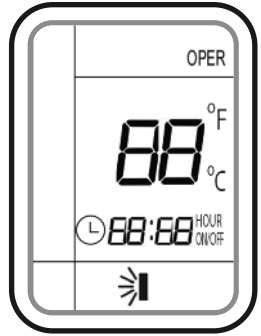

Swing Louver Display

X-FAN MODE

When operating in humid areas, ev0+ has a **DRY COIL** function called X-Fan that will allow the indoor fan to run for a pre-determined amount of time after the unit is turned off (cooling or dry modes) to ensure that additional moisture is removed from coil. Push the "X-FAN" button to enable this feature. The **X-FAN** icon will be displayed on remote controller. To deactivate this feature, push the "X-FAN" button again.

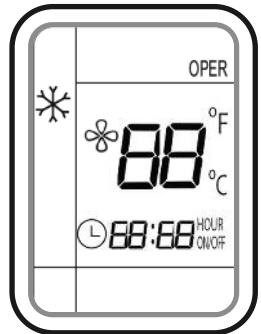

X-Fan Mode Display

OPERATION OF WIRELESS REMOTE CONTROLLER

TURBO MODE

The desired setpoint, either in heating or cooling, can be achieved faster if **TURBO** mode is used. After selecting the "HEAT" or "COOL" mode button, push the "TURBO" button. The **TURBO** icon will be displayed on the remote controller and the unit will run at ultra high speed fan. To deactivate the feature, push the "TURBO" button again. The unit will return to normal operation.

SLEEP MODE

The evō+ will automatically adjust room temperature during your sleep time. This slight change in temperature will not affect your comfort level due to the natural effects that sleeping has on the body, but it will save on energy consumption and will lower your electric bill. Press the SLEEP button to select Sleep Mode. The SLEEP icon will appear.

In Cool or Dry modes:

The unit will run at current room setpoint for 1 hour.
After 1 hour, the setpoint will increase by 2° F.
After 2 hours, the setpoint will increase by 4° F and maintain this setpoint until Sleep Mode is cancelled.

In Heat mode:

The unit will run at current room setpoint for 1 hour.
After 1 hour, the setpoint will decrease by 2° F.
After 2 hours, the setpoint will decrease by 4° F and maintain this setpoint until Sleep Mode is cancelled.

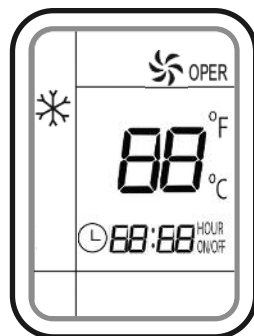

Turbo Mode Display

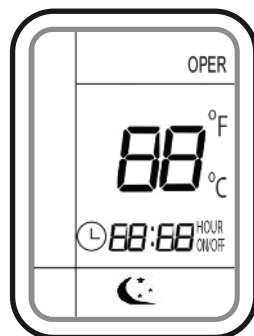

Sleep Mode Display

OPERATION OF WIRELESS REMOTE CONTROLLER

CHANGING BATTERIES AND ADDITIONAL NOTES

To change batteries, slide cover off battery compartment on back of remote controller. Remove and safely discard old batteries. Insert two new AAA 1.5V dry batteries, using correct polarity. Reattach back cover.

NOTE:

- If the remote controller will not be used for a long time, remove batteries to prevent leakage damage.
- Be sure to aim the remote controller at the receiver of the main unit when operating.
- When remote emits a signal, icon will flicker; a tone will be heard when unit receives that signal.

CHANGING BATTERIES

Remove
old batteries

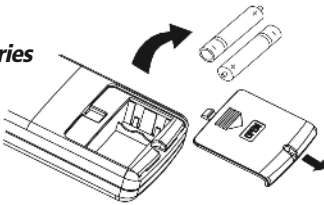

Install
new batteries

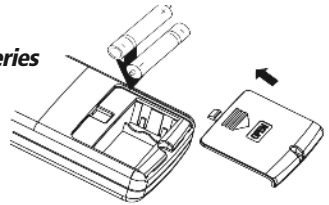

EMERGENCY OPERATION

Use the Manual Override button to manual operate the unit if the remote controller is lost or damaged. Lift up the front panel section on the indoor unit and locate the Manual Override button on the right hand side. Press the Manual Override button to turn ON the unit. The unit will operate in AUTO mode and will automatically select heating or cooling to maintain room temperature between 64°F and 77°F. The indoor fan will operate in auto fan mode. Press the Manual Override button to cancel Manual Override Mode and transfer control back to the remote controller.

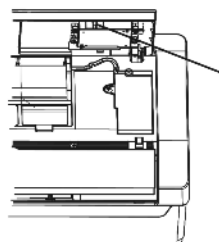
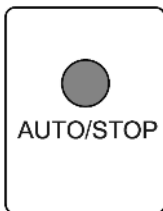

Manual
Switch

SYSTEM FUNCTIONS

TIME GUARD

The evō+ System is equipped with many system safeties to provide safe, reliable operation and comfort. The Time Guard function prevents rapid cycling of the compressor. The system has a protective 3-minute time delay to restart the compressor after it has turned off.

INTELLIGENT DEFROST

The evō+ Intelligent Defrost function increases room comfort and saves energy by eliminating unnecessary defrost cycles. In heating mode, the unit will monitor the outdoor coil for frost buildup. Once frost buildup has been detected, the system will switch into a defrost mode to remove the frost. In defrost mode the front panel LED display will show "H1" and the indoor fan and outdoor fan will turn off while the system removes frost from the outdoor coil. Once the frost has been removed, the front panel LED display show room setpoint and system will revert back to normal heating operation.

POWER FAILURE MODE

Power interruptions are no problem for the evō+ system. User selections and system parameters are stored in non-volatile memory. These parameters are retained during a power failure. When power is returned, the evō+ system will automatically return to the last operating mode.

COLD BLOW PROTECTION

The evō+ system guards against the annoying COLD BLOW in heating mode. The system constantly monitors the discharge air temperature. It will delay the indoor fan until the indoor coil has warmed up to prevent blowing uncomfortable cool air into the room.

TWO-STAGE AIR FILTER SYSTEM

evō+'s 2-stage air filter allows clean, fresh air into the living space. This air filter system efficiently and effectively filtrates dust and lint particles, while removing bacteria and deodorizing the living space.

POLYMERIC AIR FILTER

The polymeric mesh filters save energy by preventing the indoor coils from being plugged with dirt and lint. This economical and sturdy filter may be washed, vacuumed and reused.

PHOTOCATALYTIC FILTER

Photocatalytic Air Filter is a second stage filter that oxidizes and effectively eradicates organic contaminants in the air. This high-tech filter uses natural ultraviolet light with a titanium dioxide catalyst to effectively eliminate 99.9% of bacteria and viruses and absorb odors for cleaner, healthier indoor air.

CARE AND CLEANING

CAUTION

- Turn off power and disconnect unit from power source before cleaning. Failure to do so could cause electric shock.
- Never spray water on either indoor or outdoor unit. This could cause damage or unit failure.
- Never use abrasive cleaners on indoor or outdoor unit. Use only slightly damp, clean, soft cloth or very mild cleansers.

CLEANING THE FRONT PANEL

1. To remove front panel for cleaning, lift up and pull out.
2. Wash the panel with water, a soft cloth or soft brush. Use only very mild cleaners. Then dry completely.

NOTE: Take down the display panel before cleaning. Never use water above 113°F (45°C) because it may cause discoloration or damage to surface.

3. Replace front panel. Fit the sides of the panel into the slots and push into place.

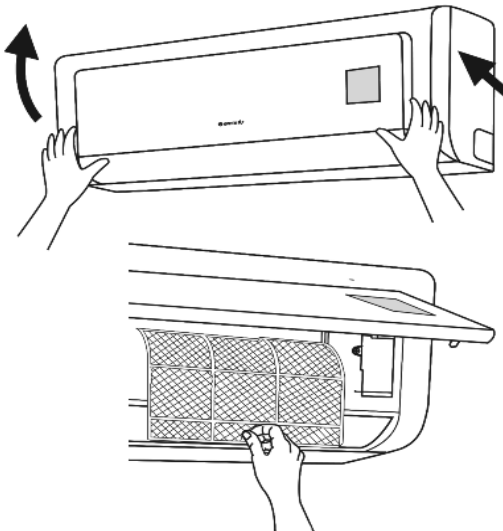

CARE AND CLEANING

CLEANING THE PRIMARY AIR FILTER

Cleaning is recommended every three months.

NOTE: If the indoor unit is exposed to excessive dust, cleaning may be necessary more often. Use caution when removing the filter to avoid sharp metal extensions.

1. Remove air filter by tilting up the unit cover and pulling filter free.
2. Clean air filter using a vacuum or warm water and mild cleaner. Air dry filter in the shade. Never use fire to clean stains or debris on filter.
3. Reinsert the filter being, careful to align properly, then close unit.

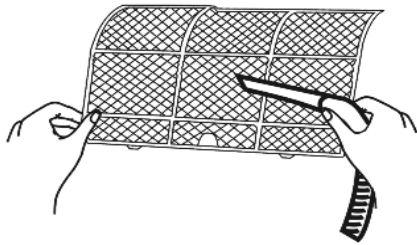

CLEANING PHOTOCATALYTIC FILTER

Clean every 2 weeks for the best results.

1. Remove photocatalytic filter from front face of primary air filter.
2. Clean lint and dust from air filter using vacuum.

NOTE: Do not get photocatalytic filter wet.

3. Place photocatalytic filter in direct sunlight for 60 minutes to energize catalyst.
4. Re-install the photocatalytic air filter on the unit by inserting it back on the primary air filter.

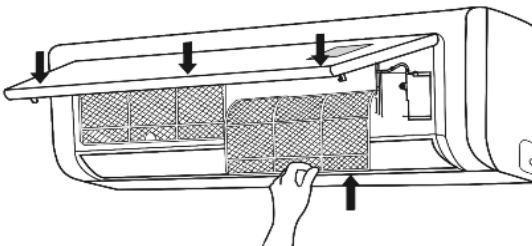

TROUBLESHOOTING



WARNING

Do not attempt any repairs on the unit yourself. Incorrect repair can cause shock or fire. Always call a qualified service professional. Using these troubleshooting suggestions can save time when you contact the qualified service professional.

PROBLEM

CAUSE/SOLUTION

System does not restart.	<p>Cause: The system has a built-in three-minute delay to prevent short and/or rapid cycling of the compressor.</p> <p>Solution: Wait three minutes for the protection delay to expire.</p>
Indoor unit emits unpleasant odor when started.	<p>Cause: Typically unpleasant odors are the result of mold or mildew forming on the coil surfaces or air filter.</p> <p>Solution: Wash indoor air filter in warm water with mild cleaner. If odors persist, contact a qualified service professional to clean the coil surfaces.</p>
You hear a “water flowing” sound.	<p>Cause: It is normal for the system to make “water flowing” or “gurgling” sounds from refrigerant pressures equalizing when the compressor starts and stops.</p> <p>Solution: The noises should discontinue as the refrigerant system equalizes after two or three minutes.</p>
A thin fog or vapor coming out of the indoor unit when system is running.	<p>Cause: It is normal for the system to emit a slight fog or water vapor when cooling extremely humid warm air.</p> <p>Solution: The fog or water vapor will disappear as the system cools and dehumidifies the room space.</p>
You hear a slight cracking sound when the system stops or starts.	<p>Cause: It is normal for the system to make “slight cracking” sounds from parts expanding and contracting during system starts and stops.</p> <p>Solution: The noises should discontinue as temperature equalizes after two or three minutes.</p>
The system will not run.	<p>Cause: There are a number of situations that will prevent the system from running.</p> <p>Solution: Check for the following:</p> <ul style="list-style-type: none"> • Circuit breaker is “tripped” or “turned off.” • Power button of remote is not turned on. • Batteries in the remote controller are low. • Remote controller is in sleep mode or timer mode. • Otherwise, you should contact a qualified service professional for assistance.
Heating or cooling not running efficiently.	<p>Cause: With routine maintenance, your system is designed for years of peak efficiency.</p> <p>Solution: Check the following:</p> <ul style="list-style-type: none"> • Remove obstructions blocking airflow into the room. • Clean dirty or blocked indoor air filter that is restricting airflow into the system. • Seal outdoor air leaks in the room space from door or windows. • Relocate (if possible) other heating sources in the room space.

TROUBLESHOOTING

PROBLEM	CAUSE/SOLUTION
Wireless remote controller lost or does not work.	<p>Cause: There are a number of possible reasons.</p> <p>Solution: Check the following:</p> <ul style="list-style-type: none"> • The batteries might be low. Change the batteries. • The remote controller must be within 25 ft. (7.6 m) with no obstructions of the indoor unit. If remote controller is lost or damaged and needs to be replaced, contact your qualified service professional for assistance. In the meantime, use the manual override mode to operate the system.
Water leaking from indoor unit into the room.	<p>Cause: While it is normal for the system to generate condensate water in cooling mode, it is designed to drain this water to the outdoors via a condensate drain tube. If water is leaking into the room, it may indicate one of the following.</p> <p>Solution:</p> <ul style="list-style-type: none"> • The indoor unit is not level right to left. Level indoor unit. • The condensate drain tube is restricted or plugged. All restrictions must be removed to allow continuous gravity force drainage. • If problem persists, contact a qualified service professional for assistance.
Water leakage in outdoor unit.	<p>Cause: It is normal for outdoor unit to generate condensate water in reverse cycle heating mode and defrost.</p> <p>Solution: This is normal. No action is required.</p>
The unit will not deliver air.	<p>Cause: There are a number of system functions that will prevent the indoor fan from running.</p> <p>Solution: Check for the following:</p> <ul style="list-style-type: none"> • In heating mode, the indoor fan may not start for three minutes if the room temperature is very low to prevent blowing cold air. • In heat mode, if the outdoor temperature is low and humidity is high, the system may need to defrost for up to 12 minutes before beginning a heating cycle. • In dry mode, the indoor fan may stop for up to three minutes during the compressor off delay. • Otherwise, you should contact a qualified service professional for assistance.
Moisture or condensation on the discharge air louvers or outlet vents.	<p>Cause: It is normal for the system to develop condensation or moisture on the discharge air louvers when cooling warm humid air for a long period of time.</p> <p>Solution: The condensation or moisture will disappear as the system cools and dehumidifies the room space.</p>



CAUTION

Stop operation and call for service in the following circumstances:

- You hear a harsh or unusual sound during operation
- Unusually foul odor is emitted during operation
- Circuit breaker trips frequently, or unit stops abnormally often
- Water is leaking in the room
- Liquid is spilled into unit
- You notice a burning smell or see smoke

SYSTEM OPERATION

COOLING OPERATION

How it works:

In cooling mode, your ev \bar{o} + indoor unit will absorb heat from the room, then the ev \bar{o} + outdoor unit will discharge the heat to the outdoors. The ev \bar{o} + cooling capacity decreases as the outdoor temperature increases. This causes the ev \bar{o} + to work harder and longer to hold the selected room temperature. Your ev \bar{o} + unit will operate in cooling down to 41°F (5°C)

Indoor Coil Freeze Protection:

Frost may form on the indoor coil during cooling operations when the outdoor temperature below 50°F (10°C). Prolong operation may cause ice to form on the indoor coil and block airflow. If the ev \bar{o} + indoor unit microcomputer detects ice on the indoor coil it will stop the compressor to defrost the coil and protect the unit.

HEATING OPERATION

How it works:

In heating mode, your ev \bar{o} + outdoor unit will absorb heat from the outdoor ambient, then the ev \bar{o} + indoor unit will discharge the heat to the room. The ev \bar{o} + heating capacity decreases as the outdoor temperature decreases. Your ev \bar{o} + unit will heat down to 5°F (-15°C).

During extreme cold outdoor temperatures, you may need an additional heating source to supplement the ev \bar{o} + heating output.

Defrost Function:

In heating mode, frost may form on the outdoor coil during humid and low outdoor temperature conditions. Prolong operation may cause ice to form on the outdoor coil and block airflow. This will reduce the ev \bar{o} +’s heating capacity.

If the ev \bar{o} + microcomputer detects ice on the outdoor coil, it will switch automatically to defrost mode to melt the ice and clear the coil. During defrost mode, heating will be discontinued and the ev \bar{o} + indoor unit will flash the Defrost indicator. The compressor will continue to run while indoor and outdoor fans will stop. It is normal to see steam or vapor coming from the outdoor unit during defrost mode. Defrost mode will terminate 12 minutes after initiation of defrost cycle or when the outdoor coil temperature is 50°F (10°C) or greater.

ENERGY SAVING TIPS

- 1. Relaxing room temperature at night is OK:** During the nighttime hours you don't require the same level of conscious cooling or heating. Try using Sleep Mode to gradually relax room temperature and allow the unit to run less and save energy.
- 2. Curtains and shades:** In the summer, you need to block the effects of the sun. Close window curtains and shades on the south and west side of your home to help block solar heat. In winter, the sun is your friend. Open curtains and shades to allow solar heat into your room.
- 3. Close doors:** If you don't need to heat and cool your whole home, confine the heating and cooling to one room by closing doors. Limit the space you're heating and cooling to specified capability of the unit.
- 4. Service the unit:** Some basic maintenance might be all you need. The outdoor unit will greatly benefit from a good hosing out, especially in treed areas where seeds and other debris can stick to coil fins and make the unit work up to 15% harder!
- 5. Rearrange the room:** Furniture that obstructs airflow means you could be heating and cooling the back of a chair or the front of a sofa instead of the actual living space. Use the Swing Louvers to help direct the air in the right direction for the room; remove or rearrange obstacles blocking airflow.
- 6. Try 75 degrees:** 75°F is a good point for an air conditioner to run at its optimal performance level. Even a 5-degree change in temperature can make your unit use up to 40% more energy!
- 7. Lighting:** Turning lights off can help reduce your heat. Each light bulb is a tiny heater. Your air conditioner must waste energy overcoming the heat from your lights to reach and hold your desired room temperature.
- 8. Is anyone home?** If possible, while you're away turn your unit to Auto mode and make sure windows and drapes are closed. Although the room temperature will be uncomfortable for a few minutes when you come home, the unit will have the room back to your desired temperature in no time.
- 9. Don't forget the fan:** The fan is much like a car. The faster it runs, the more energy it uses. Sometimes we need the car to go fast, but slow is good enough most of the time. Try saving money by using the comfortable quiet low fan speed as much as possible.



GREE ELECTRIC APPLIANCES, INC.

www.greecomfort.com



LIMITED WARRANTY

GREE distributor (hereinafter "Company") warrants this product against failure due to defect in materials or workmanship under normal use and maintenance as follows. All warranty periods begin on the date of original installation. If the date cannot be verified, the warranty period begins one hundred twenty (120) days from date of manufacture. If a part fails due to defect during the applicable warranty period Company will provide a new or remanufactured part, at Company's option, to replace the failed defective part at no charge for the part. This limited warranty is subject to all provisions, conditions, limitations and exclusions listed below.

- Seven (7) years on compressor and Five (5) years on all parts to the original registered end-user.
- One (1) year warranty on remote controller unit.
- Proper installation – Limited warranty applies only to systems that are installed by a state certified or licensed HVAC contractor, under applicable local and state law in accordance with all applicable building codes and permits; GREE installation and operation instructions and good trade practices.
- Warranty applies only to products remaining in their original installation location.
- Defective parts must be returned to the distributor through a registered servicing dealer for credit.

LIMITATIONS OF WARRANTIES: ALL IMPLIED WARRANTIES AND/OR CONDITIONS (INCLUDING IMPLIED WARRANTIES OR CONDITIONS OF MERCHANTABILITY AND FITNESS FOR A PARTICULAR USE OR PURPOSE) ARE LIMITED TO THE DURATION OF THIS LIMITED WARRANTY, SOME STATES OR PROVINCES DO NOT ALLOW LIMITATIONS ON HOW LONG AN IMPLIED WARRANTY OR CONDITION LASTS, SO THE ABOVE MAY NOT APPLY TO YOU. THE EXPRESS WARRANTIES MADE IN THIS WARRANTY ARE EXCLUSIVE AND MAY NOT BE ALTERED, ENLARGED, OR CHANGED BY ANY DISTRIBUTOR, DEALER, OR OTHER PERSON, WHATSOEVER.

THIS WARRANTY DOES NOT COVER:

1. Labor or other costs incurred for diagnosing, repairing, removing, installing, shipping, servicing or handling of either defective parts, or replacement parts, or new units.
2. Normal maintenance as outlined in the installation and servicing instructions or Owner's Manual, including filter cleaning and/or replacement and lubrication.
3. Failure, damage or repairs due to faulty installation, misapplication, abuse, improper servicing, unauthorized alteration or improper operation.
4. Failure to start due to voltage conditions, blown fuses, open circuit breakers, or damages due to the inadequacy or interruption of electrical service.
5. Failure or damage due to floods, winds, fires, lightning, accidents, corrosive environments (rust, etc.) or other conditions beyond the control of the Company.
6. Parts not supplied or designated by Company, or damages resulting from their use.
7. Products installed outside USA and Canada.
8. Electricity or fuel costs, or increases in electricity or fuel costs from any reason whatsoever, including additional or unusual use of supplemental electric heat.
9. Any cost to replace, refill or dispose of refrigerant, including the cost of refrigerant.
10. Any special, indirect or consequential property or commercial damage of any nature whatsoever. Some states or provinces do not allow the exclusion of incidental or consequential damages, so the above limitation may not apply to you.

For additional warranty exclusions, visit www.GreeComfort.com.

This warranty gives you specific legal rights, and you may also have other rights which vary from state to state or province to province.

For warranty service or repair, contact your installing contractor. You may find the installer's name on the equipment or in your Owner's packet.

Complete product registration below and send back by e-mail at service@twclimate.com

PRODUCT REGISTRATION

Model No. _____

Serial No. _____ Date of Installation _____

Owner Name _____

Address of Installation _____

Installing Contractor _____

Address _____

Phone No. / E-mail _____