

AIR CONDITIONER OUTDOOR UNIT

⚠ CAUTION

**R410A
REFRIGERANT**

This Air Conditioner contains and operates
with refrigerant R410A.

**THIS PRODUCT MUST ONLY BE INSTALLED OR SERVICED
BY QUALIFIED PERSONNEL.**

Refer to Commonwealth, State, Territory and local legislation,
regulations, codes, installation & operation manuals, before
the installation, maintenance and/or service of this product.

English

Français

Español

INSTALLATION MANUAL

For authorized personnel only.

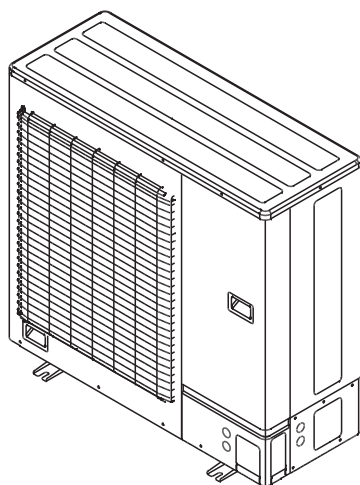

Contents

1. SAFETY PRECAUTIONS	2	6.4. Unit wiring	19
2. ABOUT THE PRODUCT		6.5. Wiring method	20
2.1. Precautions for using R410A refrigerant	4	6.6. Connecting of wiring	21
2.2. Special tools for R410A	4	7. PIPE INSTALLATION II	
2.3. Accessories	4	7.1. Sealing test	22
2.4. Optional parts	5	7.2. Vacuum process	23
2.5. Operating range	5	7.3. Additional charging	24
2.6. System configuration	6	7.4. Refrigerant recovery method	25
3. INSTALLATION WORK		7.5. Installing insulation	26
3.1. Selecting an installation location	7	7.6. Filling with putty	26
3.2. Drain installation	8	8. FIELD SETTING	
3.3. Installation dimensions	8	8.1. Field setting switches	27
3.4. Transportation of the unit	10	8.2. Function settings	28
3.5. Installation of the unit	10	9. TEST OPERATION	
4. SYSTEM CONFIGURATION		9.1. Check run	30
4.1. Piping limitation and Pipe size	11	9.2. TEST RUN	33
5. PIPE INSTALLATION		9.3. Confirming the operation of indoor unit	35
5.1. Opening a knockout hole	13	10. EXTERNAL INPUT & OUTPUT	
5.2. Separation tube connection	14	10.1. Fitting cable (option parts)	35
5.3. Flare connection (pipe connection)	14	10.2. External input	35
6. ELECTRICAL WIRING		10.3. External output	37
6.1. The precautions of electrical wiring	17	11. LED Display	
6.2. Knockout hole	18	11.1. Normal operation mode	38
6.3. Electrical requirement	18	11.2. Error display mode	38

1. SAFETY PRECAUTIONS

This installation manual describes how to install the outdoor unit only. To install the indoor unit, refer to the installation manual included with the indoor unit.

IMPORTANT!

Please Read Before Starting

This air conditioning system meets strict safety and operating standards. As the installer or service person, it is an important part of your job to install or service the system so it operates safely and efficiently.

For safe installation and trouble-free operation, you must:

- Carefully read this instruction booklet before beginning.
- Follow each installation or repair step exactly as shown.
- Observe all local, state, and national electrical codes.
- Pay close attention to all danger, warning, and caution notices given in this manual.

WARNING: This symbol refers to a hazard or unsafe practice which can result in severe personal injury or death.

CAUTION: This symbol refers to a hazard or unsafe practice which can result in personal injury and the potential for product or property damage.

- Hazard alerting symbols



Electrical



Safety / alert

If Necessary, Get Help

These instructions are all you need for most installation sites and maintenance conditions. If you require help for a special problem, contact our sales/service outlet or your certified dealer for additional instructions.

In Case of Improper Installation

The manufacturer shall in no way be responsible for improper installation or maintenance service, including failure to follow the instructions in this document.

SPECIAL PRECAUTIONS

When Wiring

ELECTRICAL SHOCK CAN CAUSE SEVERE PERSONAL INJURY OR DEATH. ONLY A QUALIFIED, EXPERIENCED ELECTRICIAN SHOULD ATTEMPT TO WIRE THIS SYSTEM.

- Do not supply power to the unit until all wiring and tubing are completed or reconnected and checked.
- Highly dangerous electrical voltages are used in this system. Carefully refer to the wiring diagram and these instructions when wiring. Improper connections and inadequate grounding can cause accidental injury or death.
- Ground the unit following local electrical codes.
- Connect all wiring tightly. Loose wiring may cause overheating at connection points and a possible fire hazard.

When Transporting

Be careful when picking up and moving the indoor and outdoor units. Get a partner to help, and bend your knees when lifting to reduce strain on your back. Sharp edges or thin aluminum fins on the air conditioner can cut your fingers.

When Installing...

...In a Ceiling or Wall

Make sure the ceiling/wall is strong enough to hold the unit's weight. It may be necessary to construct a strong wood or metal frame to provide added support.

...In a Room

Properly insulate any tubing run inside a room to prevent "sweating" that can cause dripping and water damage to walls and floors.

...In Moist or Uneven Locations

Use a raised concrete pad or concrete blocks to provide a solid, level foundation for the outdoor unit. This prevents water damage and abnormal vibration.

...In an Area with High Winds

Securely anchor the outdoor unit down with bolts and a metal frame. Provide a suitable air baffle.

...In a Snowy Area (for Heat Pump-type Systems)

Install the outdoor unit on a raised support that is higher than drifting snow. Provide snow vents.

When Connecting Refrigerant Tubing

- Keep all tubing runs as short as possible.
- Use the flare method for connecting tubing.
- Apply refrigeration compressor oil (or equivalent) used for the outdoor unit to the matching surfaces of the flare and union tubes before connecting them, then tighten the nut with a torque wrench for a leak-free connection.
- Check carefully for leaks before starting the test run.

NOTE:

Depending on the system type, liquid and gas lines may be either narrow or wide. Therefore, to avoid confusion the refrigerant tubing for your particular model is specified as either "small" or "large" rather than as "liquid" or "gas".

When Servicing

- Turn the power OFF at the main circuit breaker panel before opening the unit to check or repair electrical parts and wiring.
- Keep your fingers and clothing away from any moving parts.
- Clean up the site after you finish, remembering to check that no metal scraps or bits of wiring have been left inside the unit being serviced.
- After installation, explain correct operation to the customer, using the operating manual.

⚠ DANGER

Never touch electrical components immediately after the power supply has been turned off. Electrical shock may occur. After turning off the power, always wait 10 minutes or more before touching electrical components.

⚠ WARNING

- ① Do not use this equipment with air or any other unspecified refrigerant in the refrigerant lines.
Excess pressure can cause a rupture.
- ② During installation, make sure that the refrigerant pipe is attached firmly before you run the compressor.
Do not operate the compressor under the condition of refrigerant piping not attached properly with 2-way or 3-way valve open.
This may cause abnormal pressure in the refrigeration cycle that leads to rupture and even injury.
- ③ Do not remove the connection pipe while the compressor is in operation with 2-way or 3-way valve open.
This may cause abnormal pressure in the refrigeration cycle that leads to rupture and even injury.
- ④ When installing and relocating the air conditioner, do not mix gases other than the specified refrigerant (R410A) to enter the refrigerant cycle.
If air or other gas enters the refrigerant cycle, the pressure inside the cycle will rise to an abnormally high value and cause rupture, injury, etc.
- ⑤ When installing this system in high humidity locations, install using ground fault equipment breakers (often referred to in other countries as an ELCB earth leakage current breaker) to reduce the risk of leaking current which may result in electric shock or potential fire.

⚠ WARNING

- ① For the air conditioner to operate satisfactorily, install it as outlined in this installation manual.
- ② Connect the indoor unit and outdoor unit with the air conditioner piping and cords available standards parts.
This installation manual describes the correct connections using the installation set available from our standard parts.
- ③ Installation work must be performed in accordance with national wiring standards by authorized personnel only.
- ④ Also, do not use an extension cord.
- ⑤ Do not turn on the power until all installation work is complete.
- ⑥ Do not purge the air with refrigerants but use a vacuum pump to vacuum the installation.
- ⑦ There is not extra refrigerant in the outdoor unit for air purging.
- ⑧ Use a vacuum pump for R410A exclusively.
- ⑨ Using the same vacuum pump for different refrigerants may damage the vacuum pump or the unit.
- ⑩ Use a clean gauge manifold and charging hose for R410A exclusively.
- ⑪ If refrigerant leaks while work is being carried out, ventilate the area. If the refrigerant comes in contact with a flame, it produces a toxic gas.

- Be careful not to scratch the air conditioner when handling it.
- After installation, explain correct operation to the customer, using the operating manual.
- Let the customer keep this installation manual because it is used when the air conditioner is serviced or moved.

2. ABOUT THE PRODUCT

2.1. Precautions for using R410A refrigerant

⚠ WARNING

The basic installation work procedures are the same as conventional refrigerant models. However, pay careful attention to the following points:

- ① Since the working pressure is 1.6 times higher than that of conventional refrigerant (R22) models, some of the piping and installation and service tools are special. (See the table below.) Especially, when replacing a conventional refrigerant (R22) model with a new refrigerant R410A model, always replace the conventional piping and flare nuts with the R410A piping and flare nuts.
- ② Models that use refrigerant R410A have a different charging port thread diameter to prevent erroneous charging with conventional refrigerant (R22) and for safety. Therefore, check beforehand. [The charging port thread diameter for R410A is 1/2 UNF 20 threads per inch.]
- ③ Be careful that foreign matter (oil, water, etc.) does not enter the piping than with refrigerant models. Also, when storing the piping, securely seal the openings by pinching, taping, etc.
- ④ When charging the refrigerant, take into account the slight change in the composition of the gas and liquid phases. And always charge from the liquid phase where refrigerant composition is stable.

2.2. Special tools for R410A



Tool name	Contents of change
Gauge manifold	Pressure is high and cannot be measured with a conventional (R22) gauge. To prevent erroneous mixing of other refrigerants, the diameter of each port has been changed. It is recommended the gauge with seals -0.1 to 5.3 MPa (30in.Hg to 768 psi) for high pressure. -0.1 to 3.8 MPa (30in.Hg to 551 psi) for low pressure.
Charge hose	To increase pressure resistance, the hose material and base size were changed.
Vacuum pump	A conventional vacuum pump can be used by installing a vacuum pump adapter.
Gas leakage detector	Special gas leakage detector for HFC refrigerant R410A.



2.3. Accessories

⚠ WARNING

- For installation purposes, be sure to use the parts supplied by the manufacturer or other prescribed parts. The use of non-prescribed parts can cause serious accidents such as the unit falling, water leakage, electric shock, or fire.

Do not throw away the connecting parts until the installation has been complete.

Name and shape	Q'ty	Application
Installation manual 	1	(This book)
Drain cap 	7	For outdoor unit drain piping work
Drain pipe 	1	For outdoor unit drain piping work

Name and shape	Q'ty	Application
Binder 	3	For binding power supply cable and connection cable
Conduit plate 	1	To fix Conduit tube

2. 4. Optional parts

CAUTION

The following parts are optional parts specific to R410A refrigerant.
Do not use parts other than those listed below.

Refer to the installation manual for the Branch box and the Separation tubes.

Parts name		Model name
Separation tube		UTP-SX248A
Branch box	Primary	UTP-PU03A
	Secondary	UTP-PU03B
External connect kit (for External input/output)		UTY-XWZXZ3
External connect kit (for Base heater)		UTY-XWZXZ4

2. 5. Operating range

Operating range

	Temperature	Indoor air intake	Outdoor air intake
Cooling	Maximum	90 °F DB	115 °F DB
	Minimum	64 °F DB	23 °F DB
Heating	Maximum	88 °F DB	75 °F DB
	Minimum	60 °F DB	5 °F DB

Indoor humidity about 80% or less

2.6. System configuration

- 2 to 8 indoor units can be connected.
- The total capacity of the indoor units connected must be between 38,400 and 62,400BTU.
Ex. Eight indoor units: $7,000+7,000+7,000+7,000+7,000+7,000+7,000+12,000=61,000\text{BTU} \rightarrow \text{OK}$
- If the total capacity of the connected indoor units exceeds 62,400BTU, an error will be displayed and the units will be not operate.

For the installation method of Branch box and indoor units, refer to the installation manuals that come with them.

When installing just 1 branch box, be sure to use the primary unit.
When installing multiple branch boxes, use both the primary unit and secondary units together.

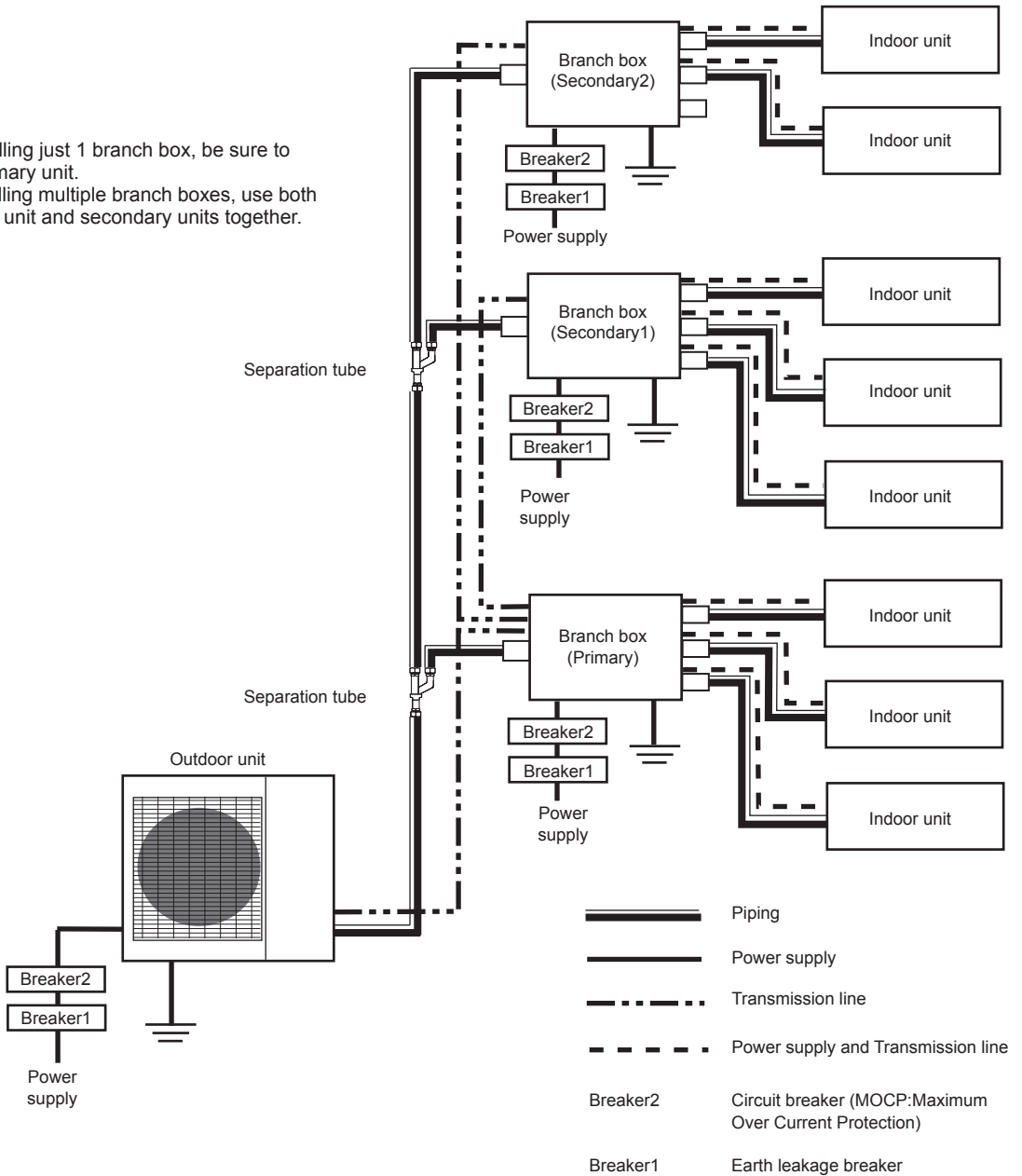

3. INSTALLATION WORK

Please obtain the approval of the customer when selecting the location of installation and installing the unit.

3. 1. Selecting an installation location

⚠ WARNING

- Securely install the outdoor unit at a location that can withstand the weight of the unit. Otherwise, the outdoor unit may fall and cause injury.
- Be sure to install the outdoor unit as prescribed, so that it can withstand earthquakes and typhoons or other strong winds. Improper installation can cause the unit to topple or fall, or other accidents.
- Do not install the outdoor unit near the edge of a balcony. Otherwise, children may climb onto the outdoor unit and fall off of the balcony.

⚠ CAUTION

- Do not install the outdoor unit in the following areas:
 - Area with high salt content, such as at the seaside. It will deteriorate metal parts, causing the parts to fail or the unit to leak water.
 - Area filled with mineral oil or containing a large amount of splashed oil or steam, such as a kitchen. It will deteriorate plastic parts, causing the parts to fail or the unit to leak water.
 - Area that generates substances that adversely affect the equipment, such as sulfuric gas, chlorine gas, acid, or alkali. It will cause the copper pipes and brazed joints to corrode, which can cause refrigerant leakage.
 - Area containing equipment that generates electromagnetic interference. It will cause the control system to malfunction, preventing the unit from operating normally.
 - Area that can cause combustible gas to leak, contains suspended carbon fibers or flammable dust, or volatile inflammables such as paint thinner or gasoline. If gas leaks and settles around the unit, it can cause a fire.
 - Area that has heat sources, vapors, or the risk of the leakage of flammable gas in the vicinity.
 - Area where small animals may live. It may cause failure, smoke or fire if small animals enter and touch internal electrical parts.
 - Area where animals may urinate on the unit or ammonia may be generated.

• Please install the outdoor unit without slant.

• Install the outdoor unit in a well-ventilated location away from rain or direct sunlight.

• If the outdoor unit must be installed in an area within easy reach of the general public, install as necessary a protective fence or the like to prevent their access.

• Install the outdoor unit in a location that would not inconvenience your neighbors, as they could be affected by the airflow coming out from the outlet, noise, or vibration. If it must be installed in proximity to your neighbors, be sure to obtain their approval.

• If the outdoor unit is installed in a cold region that is affected by snow accumulation, snow fall, or freezing, take appropriate measures to protect it from those elements. To ensure a stable operation, install inlet and outlet ducts.

• Install the outdoor unit in a location that is away from exhaust or the vent ports that discharge vapor, soot, dust, or debris.

• Install the indoor unit, outdoor unit, power supply cable, connection cable, and remote control cable at least 1 m (40in.) away from a television or radio receivers. The purpose of this is to prevent TV reception interference or radio noise. (Even if they are installed more than 1 m (40in.) apart, you could still receive noise under some signal conditions.)

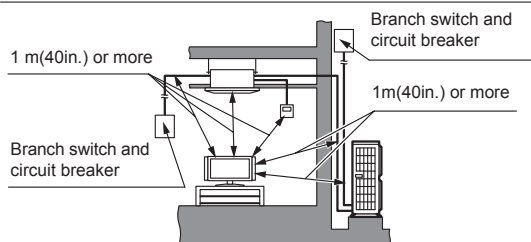

• If children under 10 years old may approach the unit, take preventive measures so that they cannot reach the unit.

• Keep the length of the piping of the indoor and outdoor units within the allowable range.

• For maintenance purposes, do not bury the piping.

3. 2. Drain installation

⚠ CAUTION

- Perform drain work in accordance with this Manual, and ensure that the drain water is properly drained. If the drain work is not carried out correctly, water may drip down from the unit, wetting the furniture.
- When the outdoor temperature is 0 °C(32°F) or less, do not use the accessory drain pipe and drain cap. If the drain pipe and drain cap are used, the drain water in the pipe may freeze in extremely cold weather. (Reverse cycle model only)
- As the drain water flows out of the outdoor unit during heating operation, install the drain pipe and connect it to a commercial 16mm (5/8in.) hose. (Reverse cycle model only)
- When installing the drain pipe, plug all the holes other than the drain pipe mounting hole in the bottom of the outdoor unit with putty so there is no water leakage. (Reverse cycle model only)

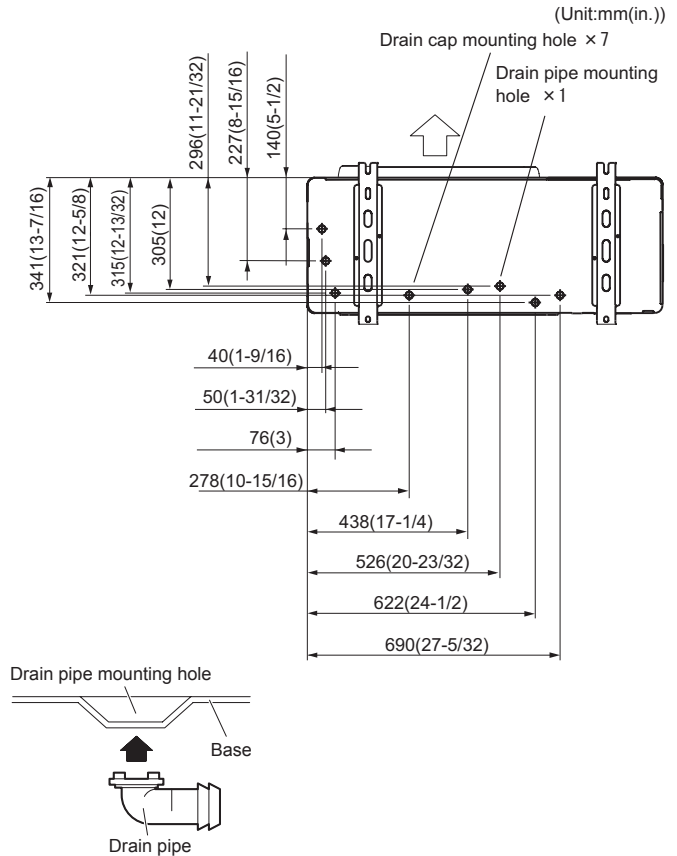

3. 3. Installation dimensions

⚠ CAUTION

- The installation space shown in the following examples is based on an ambient temperature under cooling operation of 35 °C (DB)(95°F DB) at the air intake of the outdoor unit. Provide more space around the air intake than shown in the examples if the ambient temperature exceeds 35 °C (DB)(95°F DB) or if the thermal load of all of the outdoor units exceeds the capacity.
- Consider the transportation route, installation space, maintenance space, and access, and install the unit in a location with sufficient space for the refrigerant piping.
- Observe the installation space specifications that are shown in the figures.
Provide the same space for the air intake at the rear of the outdoor unit.
If the installation is not performed according to the specifications, it could cause a short circuit and result in a lack of operating performance. As a result, the outdoor unit might easily be stopped by high-pressure protection.
- Installation methods not shown in the following examples are not recommended. Performance may drop significantly.

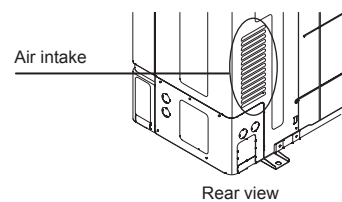

3. 3. 1. Single outdoor unit installation

When the upward area is open (Unit:mm(in.))

(1) Obstacles at rear only

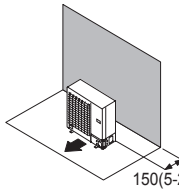

(2) Obstacles at rear and sides only

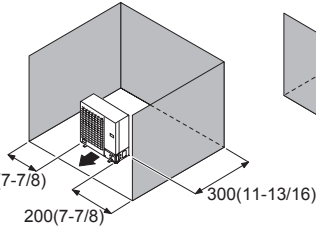

(3) Obstacles at front only

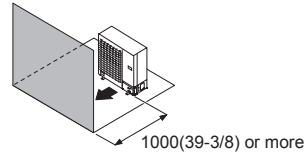

(4) Obstacles at front and rear only

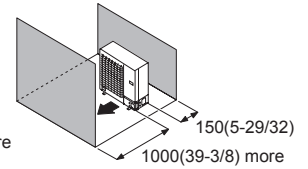

When an obstruction is present also in the upward area (Unit : mm(in.))

(1) Obstacles at rear and above only

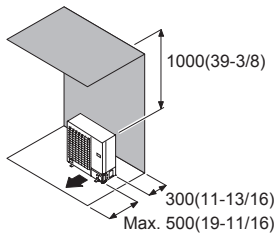

(2) Obstacles at rear, sides, and above only

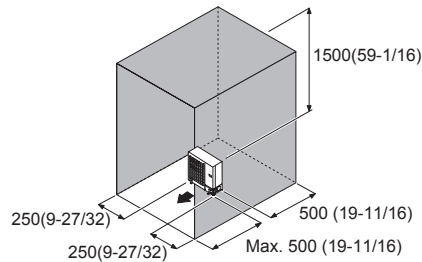

3. 3. 2. Multiple outdoor unit installation

- Provide at least 25mm (1in.) of space between the outdoor units if multiple units are installed.
- When routing the piping from the side of an outdoor unit, provide space for the piping.
- No more than 3 units must be installed side by side.

When 3 units or more are arranged in a line, provide the space as shown in the following example when an obstruction is present also in the upward area.

When the upward area is open (Unit: mm(in.))

(1) Obstacles at rear only

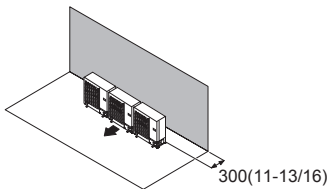

(2) Obstacles at front only

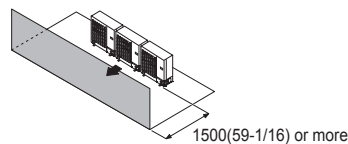

(3) Obstacles at front and rear only

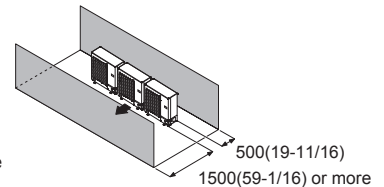

When an obstruction is present also in the upward area (Unit: mm(in.))

- Obstacles at rear and above only

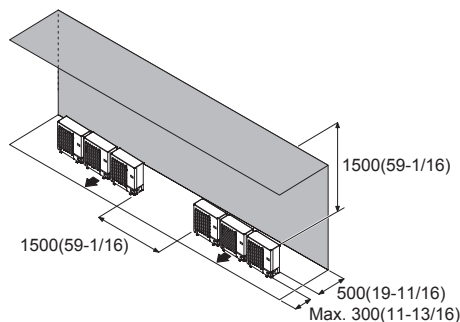

3.3.3. Outdoor units installation in multi row (Unit: mm(in.))

(1) Single parallel unit arrangement

(2) Multiple parallel unit arrangement

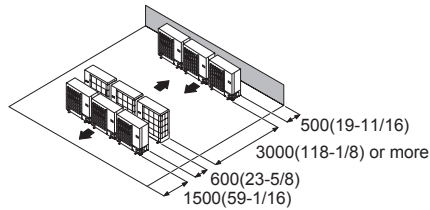
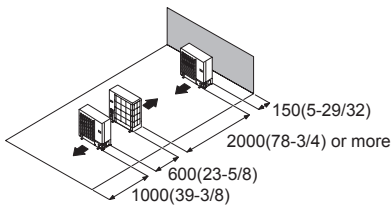

3.4. Transportation of the unit

⚠ WARNING

- Do not touch the fins. Otherwise, personal injury could result.

⚠ CAUTION

- When carrying the unit, hold the handles on the right and left sides and be careful. If the outdoor unit is carried from the bottom, hands or fingers may be pinched.
- Be sure to hold the handles on the sides of the unit. Otherwise, holding the suction grille on the sides of the unit may cause deformation.

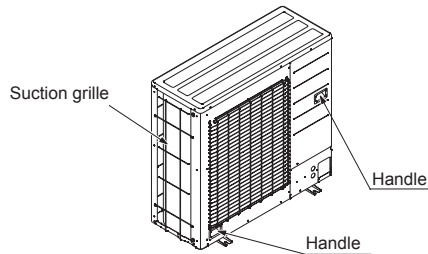
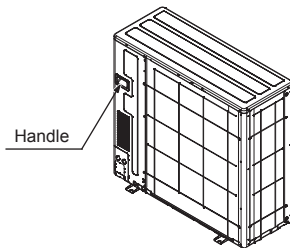

3.5. Installation of the unit

- Install 4 anchor bolts at the locations indicated with arrows in the figure.
- To reduce vibration, do not install the unit directly on the ground. Install it on a secure base (such as concrete blocks).
- The foundation shall support the legs of the unit and have a width of 50mm(1-31/32in.) or more.
- Depending on the installation conditions, the outdoor unit may spread its vibration during operation, which may cause noise and vibration. Therefore, attach damping materials (such as damping pads) to the outdoor unit during installation.
- Install the foundation, making sure that there is enough space for installing the connection pipes.
- Secure the unit to a solid block using foundation bolts. (Use 4 sets of commercially available M10(3/8in.) bolts, nuts, and washers.)
- The bolts should protrude 20mm(25/32in.). (Refer to the figure.)
- If overturning prevention is required, purchase the necessary commercially available items.

(Unit : mm(in.))

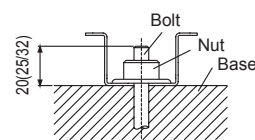
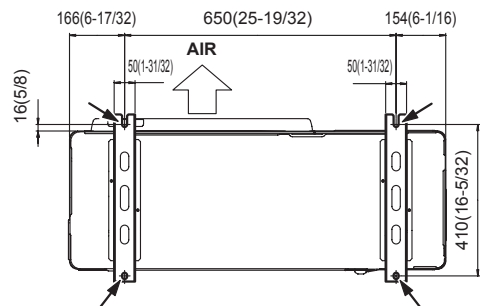

4. SYSTEM CONFIGURATION

4. 1. Piping limitation and Pipe size

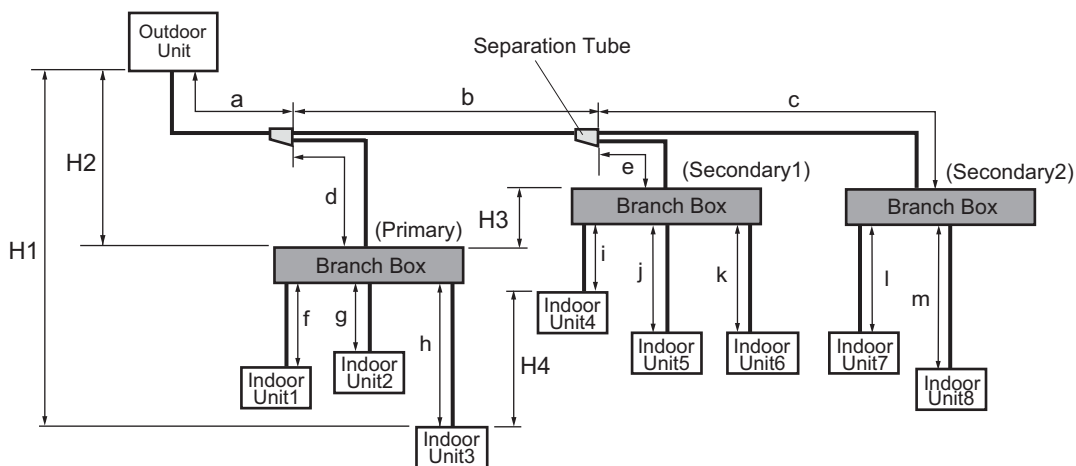

Pipe limitation

		Limitation m (ft)	Diagram	
Allowable pipe length (actual pipe length)	Maximum total equivalent pipe length	115 or less (377)	Total	
	Between outdoor unit and the farthest indoor unit	70 or less (230)	a + b + c + m	
	Between outdoor unit and branch boxes	55 or less (180)	a + b + c + d + e	
	Between branch box and indoor unit	Total	60 or less (197)	f + g + h + i + j + k + l + m
		Each unit	Between 3-15 (10-49)	f, g, h, i, j, k, l, m
	Between outdoor unit and the first separation tube	5 or more (16)	a	
Between outdoor unit and branch box (when there is no separation tube)	5 or more (16)	a+d		
Allowable height difference	Between outdoor unit and indoor unit	30 or less (98)	H1	
	Between outdoor unit and branch box	30 or less (98)	H2	
	Between branch box and branch box	15 or less (49)	H3	
	Between indoor unit and indoor unit	15 or less (49)	H4	

Pipe size selection

	Diagram	Condition (Model code of indoor unit)	Gas pipe (mm(in.))	Liquid pipe (mm(in.))
Between outdoor unit and first separation tube	a	—	Φ15.88 (5/8)	Φ9.52 (3/8)
Between first separation tube and second separation tube	b	—	Φ15.88 (5/8)	Φ9.52 (3/8)
Between separation tube and branch box	c, d, e	—	Φ15.88 (5/8)	Φ9.52 (3/8)
Between branch box and indoor unit	f, g, h, i,	7, 9, 12	Φ9.52 (3/8)	Φ6.35 (1/4)
		18	Φ12.70 (1/2)	Φ6.35 (1/4)
	j, k, l, m	24	Φ15.88 (5/8)	Φ6.35 (1/4)

Pipe material

It is necessary to use seamless copper pipes and it is desirable that the amount of residual oil is less than 40mg/10m (0.004oz/100ft). Do not use copper pipes having a collapsed, deformed or discolored portion (especially on the interior surface). Otherwise, the expansion valve or capillary tube may become blocked with contaminants.

As an air conditioner using R410A incurs pressure higher than when using conventional refrigerant (R22), it is necessary to choose adequate materials.

Thicknesses of copper pipes used with R410A are as shown in the table. Never use copper pipes thinner than that in the table even when it is available on the market.

Thicknesses of Annealed Copper Pipes (R410A)

Pipe outside diameter (mm (in.))	Thickness (mm (in.))
6.35 (1/4)	0.80 (0.032)
9.52 (3/8)	0.80 (0.032)
12.70 (1/2)	0.80 (0.032)
15.88 (5/8)	1.00 (0.039)
19.05 (3/4)	1.20 (0.047)

* JIS H3300 C1220T-O or equivalent

* Please select the pipe size in accordance with local rules.

5. PIPE INSTALLATION

5. 1. Opening a knockout hole

⚠ CAUTION

- Be careful not to deform or scratch the panel while opening the knockout holes.
- To protect the piping insulation after opening a knockout hole, remove any burrs from the edge of the hole. It is recommended to apply rust prevention paint to the edge of the hole.
- Pipes can be connected from 4 directions, front, lateral side, rear side and bottom. (Fig. A)
- When connecting at the bottom, remove the service panel and piping cover on the front of the outdoor unit, and open the knockout hole provided at the bottom corner of the piping outlet.
- It can be installed as shown on "Fig. B" cutting out the 2 slits as indicated on "Fig. C". (When cutting slits, use a steel saw.)

Fig. A

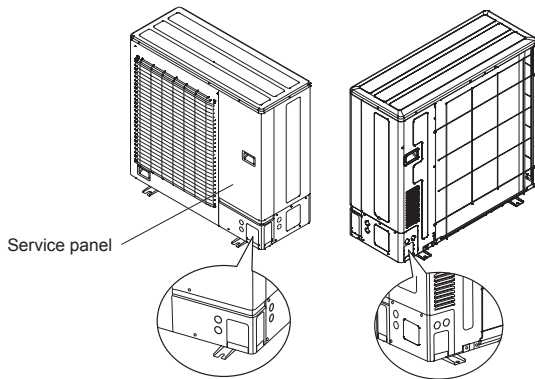

Fig. B

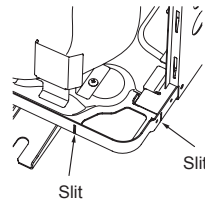
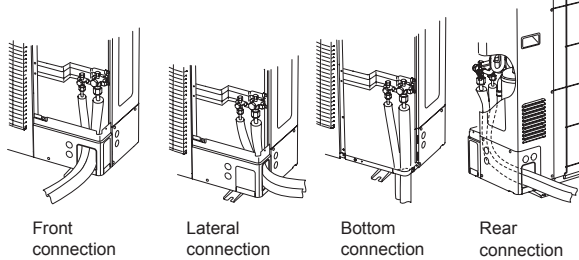
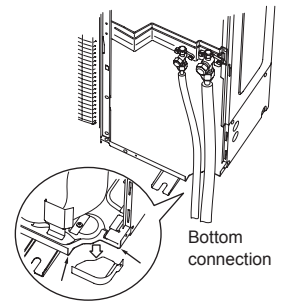

Fig. C



5. 2. Separation tube connection

⚠ CAUTION

- Use genuine separation tubes for the refrigerant piping branches. Separation tubes may be used for piping between the outdoor unit and branch box.
- Select number of separation tubes and purchase it before starting the installation work.
- Any vertical piping shall be in the part of the main piping. If a main pipe is bent, keep the straight part more than 10 times the diameter of the connected pipe. A variance in the amount of refrigerant may be caused if the straight part is short.
- For details, refer to the Installation Manual of separation tubes.

⚠ CAUTION

Separation tube

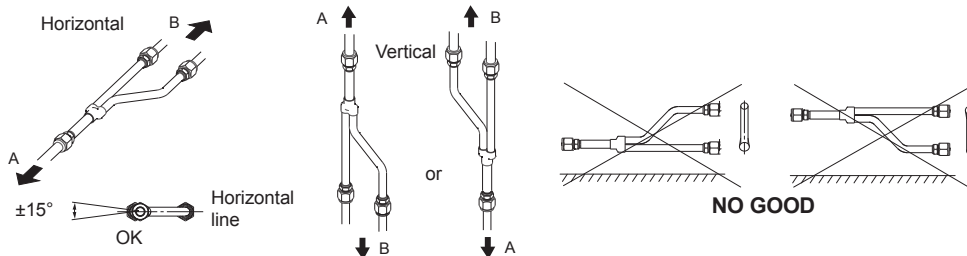

A : Outdoor unit or Separation tube

B : Branch box or Separation tube

Name and shape

Liquid pipe

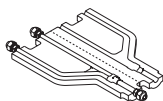

Gas pipe

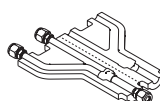

5. 3. Flare connection (pipe connection)

⚠ CAUTION

- Do not use mineral oil on a flared part. Prevent mineral oil from getting into the system as this would reduce the lifetime of the units.
- While welding the pipes, be sure to blow dry nitrogen gas through them.
- The maximum lengths of this product are shown in the table. If the units are further apart than this, correct operation cannot be guaranteed.

5. 3. 1. Flaring

- Use special pipe cutter and flare tool exclusive for R410A.

- (1) Cut the connection pipe to the necessary length with a pipe cutter.
- (2) Hold the pipe downward so that the cuttings will not enter the pipe and remove any burrs.
- (3) Insert the flare nut (always use the flare nut attached to the indoor and outdoor units respectively) onto the pipe and perform the flare processing with a flare tool. Leakage of refrigerant may result if other flare nuts are used.
- (4) Protect the pipes by pinching them or with tape to prevent dust, dirt, or water from entering the pipes.

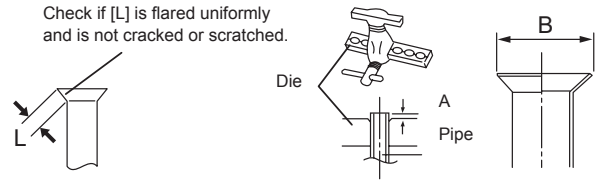

Pipe outside diameter [mm (in.)]	Dimension A (mm (in.)) Flare tool for R410A, clutch type	Dimension B ⁰ - 0.4 [mm (in.)]
6.35 (1/4)	0 to 0.5 (0 to 0.02)	9.1 (11/32)
9.52 (3/8)		13.2 (17/32)
12.70 (1/2)		16.6 (21/32)
15.88 (5/8)		19.7 (25/32)

- When using conventional flare tools to flare R410A pipes, the dimension A should be approximately 0.5mm (0.02in.) more than indicated in the table (for flaring with R410A flare tools) to achieve the specified flaring. Use a thickness gauge to measure the dimension A.

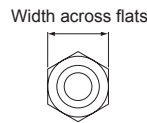

Pipe outside diameter [mm (in.)]	Width across flats of Flare nut [mm (in.)]
6.35 (1/4)	17 (21/32)
9.52 (3/8)	22 (7/8)
12.70 (1/2)	26 (1-1/32)
15.88 (5/8)	29 (1-5/32)

5. 3. 2. Bending pipes

⚠ CAUTION

- To prevent breaking of the pipe, avoid sharp bends. Bend the pipe with a radius of curvature of 100mm (4in.) or more.
- If the pipe is bent repeatedly at the same place, it will break.
- If pipes are shaped by hand, be careful not to collapse them.
- Do not bend the pipes at an angle of more than 90°.
- When pipes are repeatedly bent or stretched, the material will harden, making it difficult to bend or stretch them any more.
- Do not bend or stretch the pipes more than 3 times.

5. 3. 3. Pipe connection

⚠ CAUTION

- Be sure to install the pipe against the port on the indoor unit and the outdoor unit correctly. If the centering is improper, the flare nut cannot be tightened smoothly. If the flare nut is forced to turn, the threads will be damaged.
- Do not remove the flare nut from the outdoor unit pipe until immediately before connecting the connection pipe.
- After installing the piping, make sure that the connection pipes do not touch the compressor or outer panel. If the pipes touch the compressor or outer panel, they will vibrate and produce noise.

- (1) Detach the caps and plugs from the pipes.
- (2) Center the pipe against the port on the outdoor unit, and then turn the flare nut by hand.
- (3) Tighten the flare nut of the connection pipe at the outdoor unit valve connector.
- (4) After tightening the flare nut by hand, use a torque wrench to fully tighten it.

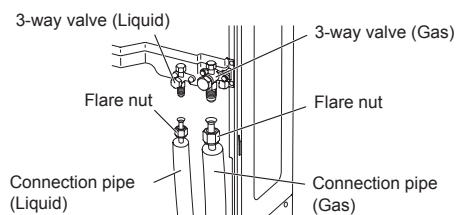

⚠ CAUTION

- Hold the torque wrench at its grip, keeping it in a right angle with the pipe, in order to tighten the flare nut correctly.
- Outer panel may be distorted if fastened only with a wrench. Be sure to fix the elementary part with a holding wrench (spanner) and fasten with a torque wrench (refer to below diagram). Do not apply force to the blank cap of the valve or hang a wrench, etc., on the cap. If blank cap is broken, it may cause leakage of refrigerant.

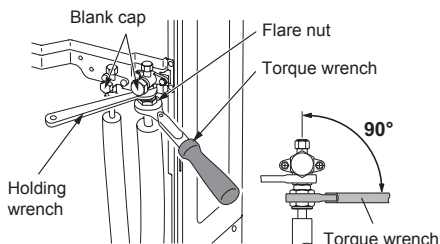

Flare nut [mm (in.)]	Tightening torque [N·m (lbf·ft)]
6.35 (1/4) dia.	16 to 18 (11.8 to 13.3)
9.52 (3/8) dia.	32 to 42 (23.6 to 31.0)
12.70 (1/2) dia.	49 to 61 (36.1 to 45.0)
15.88 (5/8) dia.	63 to 75 (46.5 to 55.3)
19.05 (3/4) dia.	90 to 110 (66.4 to 81.1)

5.3.4. Handling precautions for the valves

- Mounted part of Blank cap is sealed for protection.
- Fasten blank cap tightly after opening valves.

Operating the valves

- Use a hexagon wrench (size 4mm (5/32in.)).
- Opening
 - (1) Insert the hexagon wrench into the valve shaft, and turn it counterclockwise.
 - (2) Stop turning when the valve shaft can no longer be turned. (Open position)
- Closing
 - (1) Insert the hexagon wrench into the valve shaft, and turn it clockwise.
 - (2) Stop turning when the valve shaft can no longer be turned. (Closed position)

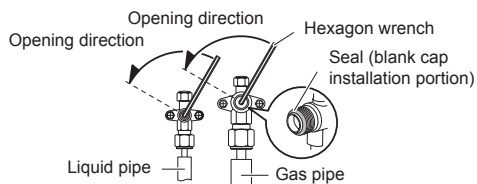

6. ELECTRICAL WIRING

6.1. The precautions of electrical wiring

WARNING

- Wiring connections must be performed by a qualified person in accordance with specifications. The rated supply of this product is 60Hz, 208/230V. Use a voltage within the range of 187-264V.
- Before connecting the wires, make sure the power supply is OFF.
- When installing this system in high humidity locations, install using ground fault equipment breakers (often referred to in other countries as an ELCB earth leakage current breaker) to reduce the risk of leaking current which may result in electric shock or potential fire.
- Be sure to install a breaker of the specified capacity. When selecting breaker, please comply with the laws and the regulations of each country. One breaker must be installed on the power supply of the outdoor unit. Wrong selection and setup of the breaker will cause electric shock or fire.
- Do not connect AC power supply to the transmission line terminal board. Improper wiring can damage the entire system.
- Connect the connector cord securely to the terminal. Faulty installation can cause a fire.
- Make sure to secure the insulation portion of the connector cable with the cord clamp. A damaged insulation can cause a short circuit.
- Never install a power factor improvement condenser. Instead of improving the power factor, the condenser may overheat.
- Before servicing the unit, turn the power supply switch OFF. Then, do not touch electric parts for 10 minutes due to the risk of electric shock.
- Make sure to perform grounding work. Improper grounding work can cause electric shocks.

CAUTION

- The primary power supply capacity is for the air conditioner itself, and does not include the concurrent use of other devices.
- Do not use crossover power supply wiring for the outdoor unit.
- If the electrical power is inadequate, contact your electric power company.
- Install a breaker in a location that is not exposed to high temperatures. If the temperature surrounding the breaker is too high, the amperage at which the breaker cuts out may decrease.
- We suggest installing GFEB breakers or follow local electrical code. This system uses an inverter, which means that when used with a ground fault breaker you must use breakers that can handle higher harmonics such as a (GFEB) Ground Fault Equipment Breaker (30 mA or greater) in order to prevent malfunctioning of ground fault device.
- When the electrical switchboard is installed outdoors, place it under lock and key so that it is not easily accessible.
- Do not fasten the power supply cable and connection cable together.
- Always keep to the maximum length of the connection cable. Exceeding the maximum length may lead to erroneous operation.
- The static electricity that is charged to the human body can damage the control PC Board when handling the control PC Board for address setting, etc. Please keep caution to the following points.
Provide the grounding of Indoor unit, Outdoor unit and Option equipment.
Cut off the power supply (breaker).
Touch the metal section (such as the unpainted control box section) of the indoor or outdoor unit for more than 10 seconds. Discharge the static electricity in your body.
Never touch the component terminal or pattern on the PC Board.

6. 2. Knockout hole

⚠ CAUTION

- Be careful not to deform or scratch the panel while opening the knockout holes.
- When cables are routed from the unit, a protection sleeve for the conduits can be inserted at the knockout hole.
- If you do not use a wire conduit, be sure to protect the wires to prevent the edge of the knockout hole from cutting the wires.
- It is recommended to apply anti-rust paint to the edge of the knockout hole.

• Knock out holes are provided for wiring. (Fig. A)

• Knock out holes are provided 2 each in the same size in front, lateral and rear sides. (Fig. B)

Fig. A

Fig. B

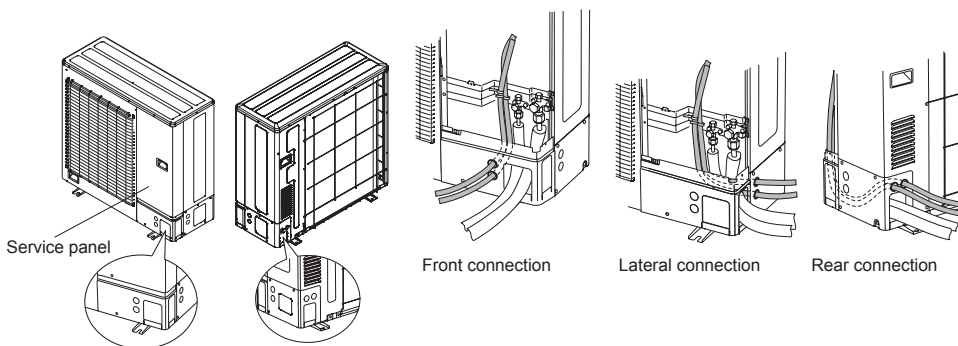

6. 3. Electrical requirement

⚠ CAUTION

Be sure to install a breaker of the specified capacity.

Regulation of cables and breaker differs from each locality, refer in accordance with local rules.

Voltage rating	1Φ 208/230V (60Hz)
Operating range	187-264V

Cable	Cable size *1)	Remarks
Power supply cable	8AWG	2 cable + Ground, 1 Ø 208/230V
Connection cable	14AWG	3 cable + Ground, 1 Ø 208/230V

- 1) Selected sample: Select the correct cable type and size according to the country or region's regulations.
 Max. wire length: Set a length so that the voltage drop is less than 2%. Increase the wire diameter when the wire length is long.

Breaker	Specification *2)
Circuit breaker (MOCP) *4)	Current : 40 (A)
Earth leakage breaker	Leakage current : 30mA 0.1sec or less *3)

2) Select the appropriate breaker of the described specification according to the national or regional standards.

3) Select the breaker that enough load current can pass through it.

4) MOCP: Maximum Over Current Protection

6.4. Unit wiring

- When stripping off the coating of a lead wire, always use a special tool such as a wire stripper. If there is no special tool available, carefully strip the coating with a knife etc.

How to connect wiring to the terminal

Caution when wiring cable

- Use crimp-type terminals with insulating sleeves as shown in the figure to connect to the terminal block.
- Securely clamp the crimp-type terminals to the wires using an appropriate tool so that the wires do not come loose.
- Use the specified wires, connect them securely, and fasten them so that there is no stress placed on the terminals.
- Use an appropriate screwdriver to tighten the terminal screws. Do not use a screwdriver that is too small, otherwise, the screw heads may be damaged and prevent the screws from being properly tightened.
- Do not tighten the terminal screws too much, otherwise, the screws may break.
- See the table below for the terminal screw tightening torques.

Tightening torque [N·m (lbf·in.)]	
M4 screw	1.2 to 1.8 (11 to 16)
M5 screw	2.0 to 3.0 (17 to 25)

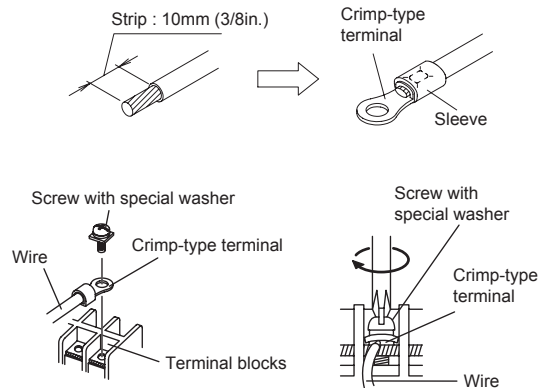
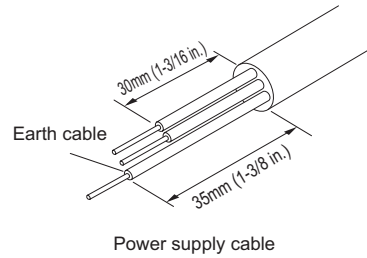

6. 5. Wiring method

The wiring example for Outdoor unit, Indoor units and Branch box is shown in figure.
For other connections, refer to Design&Technical Manual.

[Example 1]

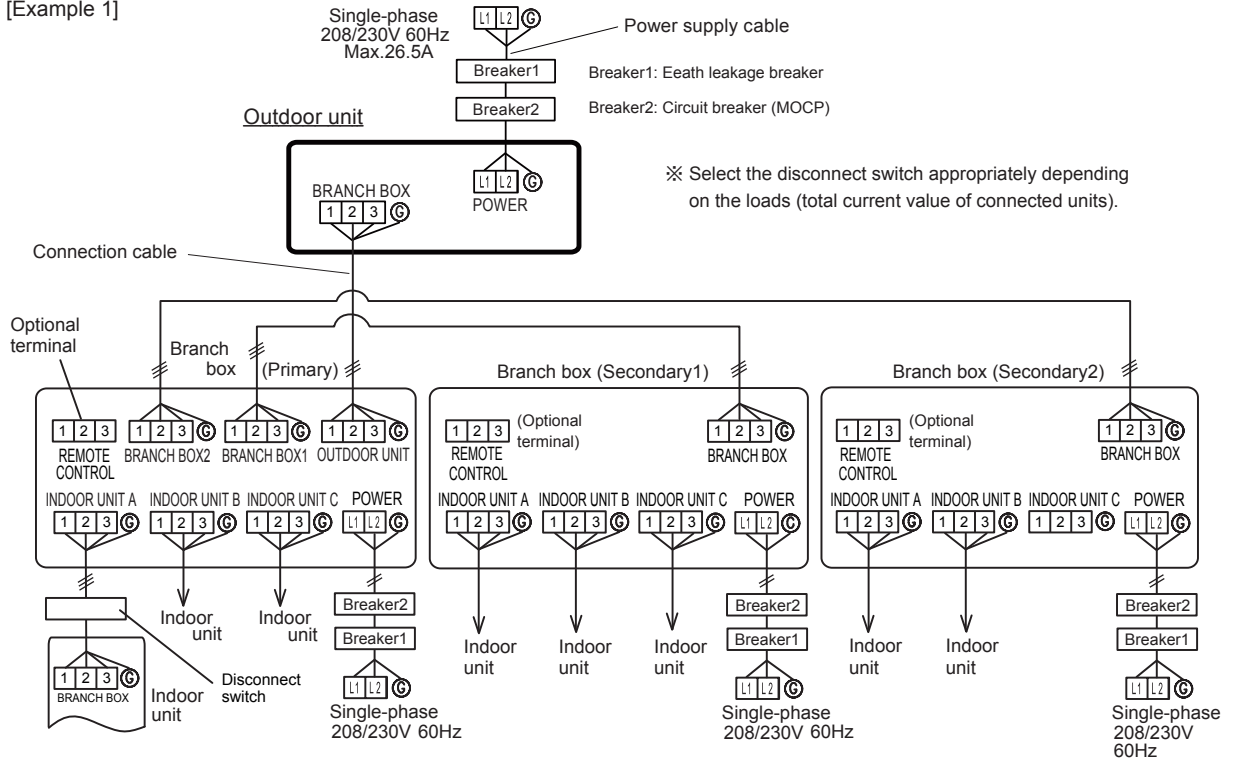

[Example 2]

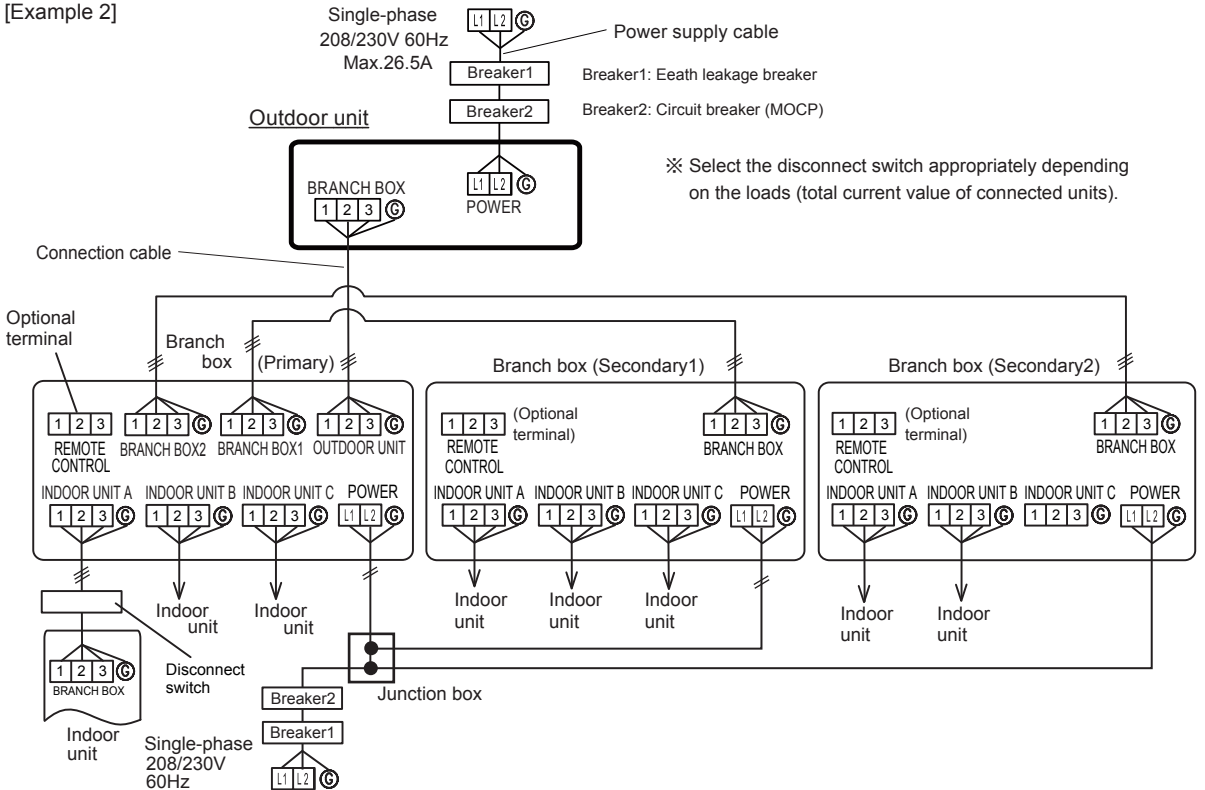

6. 6. Connecting of wiring

- (1) Remove the service covers and insulation sheet. And connect the wires to the terminal in accordance with the terminal nameplate. (Fig. A, Fig. B)
- (2) After connecting the wires, use binders to secure the wires. (Fig. B)
 - Connect the wires without applying excessive tension.

Fig. A

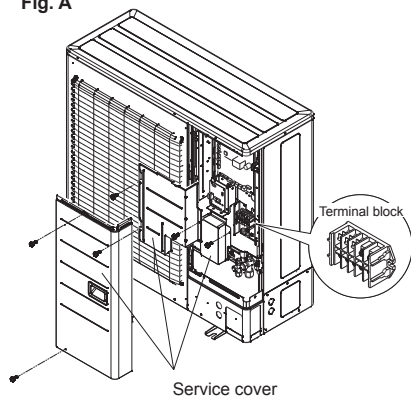
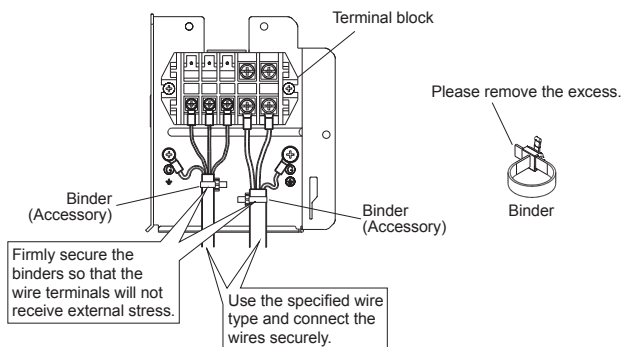
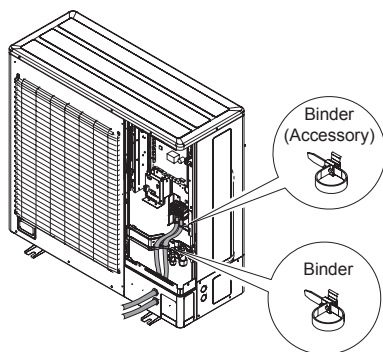

Fig. B



- (3) Secure the cables using the binders under the terminal blocks, and then secure the cables using the binders attached to the base of the valves.



- (4) Be sure to install the insulation sheet after the wiring is complete.

Installation method of conduit plate

Please fix the conduit plate (accessory) as shown in the figure below.

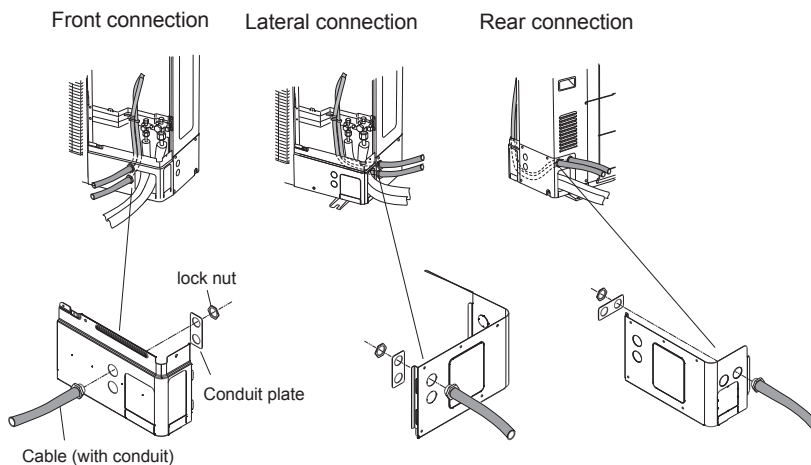

7. PIPE INSTALLATION II

7.1. Sealing test

WARNING

- Before operating the compressor, install the pipes and securely connect them. Otherwise, if the pipes are not installed and if the valves are open when the compressor operates, air could enter the refrigeration cycle. If this happens, the pressure in the refrigeration cycle will become abnormally high and cause damage or injury.
- After the installation, make sure there is no refrigerant leakage. If the refrigerant leaks into the room and becomes exposed to a source of fire such as a fan heater, stove, or burner, it produces a toxic gas.
- Do not subject the pipes to strong shocks during the sealing test. It can rupture the pipes and cause serious injury.

CAUTION

- For maintenance purposes, do not bury the piping of the outdoor unit.
- After connecting the pipes, perform a sealing test.
- Make sure that the 3-way valves are closed before performing a sealing test.
- Pressurize nitrogen gas to 4.15MPa (600psi) to perform the sealing test.
- Add nitrogen gas to both the liquid pipes and the gas pipes.
- Check all flare connections and welds. Then, check that the pressure has not decreased.
- Compare the pressures after pressurizing and letting it stand for 24 hours, and check that the pressure has not decreased. If the pressure has dropped, the pipe joints may be leaking.
 - * When the outdoor air temperature changes 5 °C (9 °F), the pressure changes 0.05MPa (7.25psi). When outdoor air temperature raises/drops by 5°C (9 °F), the pressure will raise/fall by 0.05MPa (7.25psi) accordingly.
- If a leak is found, immediately repair it and perform the sealing test again.
- After completing the sealing test, release the nitrogen gas from both valves.
- Release the nitrogen gas slowly.

7.2. Vaccum process

⚠ CAUTION

- Perform a refrigerant leakage test (air tightness test) to check for leaks using nitrogen gas while all valves in the outdoor unit are closed. (Use the pressure indicated on the nameplate.)
- Be sure to evacuate the refrigerant system using a vacuum pump.
- The refrigerant pressure may sometimes not rise when a closed valve is opened after the system is evacuated using a vacuum pump. This is caused by the closure of the refrigerant system of the outdoor unit by the electronic expansion valve. This will not affect the operation of the unit.
- If the system is not evacuated sufficiently, its performance will drop.
- Use a clean gauge manifold and charging hose that were designed specifically for use with R410A. Using the same vacuum equipment for different refrigerants may damage the vacuum pump or the unit.
- Do not purge the air with refrigerants, but use a vacuum pump to evacuate the system.

- 1) Check that the valves are closed by removing the blank caps from the gas and liquid pipes.
- 2) Remove the charging port cap, and connect the gauge manifold and the vacuum pump to the charging valve with the service hoses.
- 3) Vacuum the indoor unit and the connecting pipes until the pressure gauge indicates -0.1 MPa (500microns).
- 4) When -0.1 MPa (500microns) is reached, make sure it hold vacuum for 60 minutes.
- 5) Disconnect the service hoses and fit the charging port cap to the charging valve to the specified torque. (Refer to below table)
- 6) Remove the blank caps, and fully open the 3-way valves with a hexagon wrench [Torque: 6 to 7 N·m (4.4 to 5.2 lbf·ft)].
- 7) Tighten the blank caps of the 3-way valve to the specified torque.

	Tightening torque [N·m (lbf·ft)]
Charging port cap	10 to 12 (7.4 to 8.8)
3-way valve	6 to 7 (4.4 to 5.2)

Blank cap [mm (in.)]	Tightening torque [N·m (lbf·ft)]
6.35 (1/4)	20 to 25 (14.8 to 18.4)
9.52 (3/8)	20 to 25 (14.8 to 18.4)
12.70 (1/2)	25 to 30 (18.4 to 22.1)
15.88 (5/8)	30 to 35 (22.1 to 25.8)
19.05 (3/4)	35 to 40 (25.8 to 29.5)

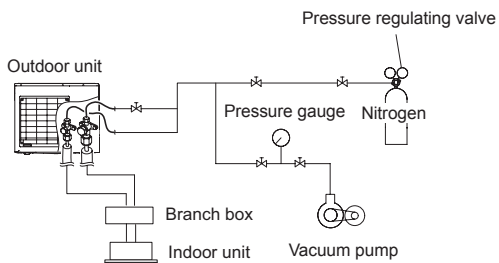
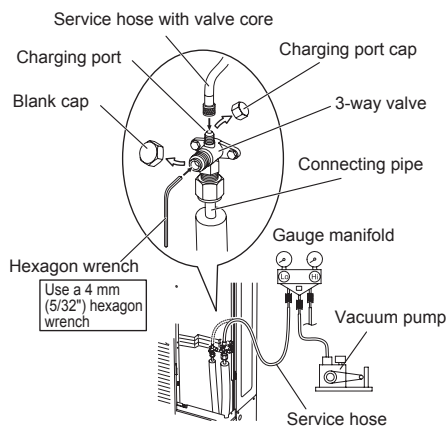

7. 3. Additional charging

⚠ CAUTION

- Do not turn on the power unless all operations are complete.
- Do not charge the system with a refrigerant other than R410A.
- Do not reuse recovered refrigerant.
- Use an electronic scale to measure the charging amount of refrigerant.
Adding more refrigerant than the specified amount will cause a malfunction.
- Charge refrigerant using the liquid pipe.
Adding refrigerant through the gas pipe will cause a malfunction.
- Add refrigerant by charging the system with the refrigerant in the liquid state. If the refrigerant cylinder is equipped with a siphon, it is not necessary to place the cylinder upright.

7. 3. 1. Procedure for charging the system with refrigerant

- 1) Remove the charging cap from the liquid pipe.
- 2) Attach a charging hose to the refrigerant cylinder, and connect it to the charging port.
- 3) Add refrigerant by calculating the additional refrigerant volume in accordance with the calculation formula indicated below.
- 4) Remove the charging hose and install the charging cap.
- 5) Remove the blank caps (gas pipe, liquid pipe), and open the valves.
- 6) Close the blank caps.
- 7) After adding refrigerant, indicate the added charging volume on the unit.

* Tighten the blank caps and charging caps to the torque values specified.
To open and close the valves, use an M4(5/32in.) hexagon wrench for liquid and gas pipes.

7. 3. 2. Calculating the amount of refrigerant charge to be added

- Round up the value to 2 decimal places.

Diameter of liquid pipe (mm (in.))	Additional amount for pipe length (kg/m (oz./ft))
Φ6.35 (1/4)	0.021 (0.224)
Φ9.52 (3/8)	0.058 (0.624)

Calculation of additional amount for pipe length

$$L = \begin{array}{|c|c|} \hline \text{Total length of} & \times 0.058 \\ \Phi 9.52\text{mm} & \text{kg/m} \\ (\Phi 3/8\text{in.}) & (0.624 \\ \text{liquid pipe} & \text{oz./ft}) \\ \hline \text{m (ft)} & \\ \hline \text{kg (oz.)} & \end{array} + \begin{array}{|c|c|} \hline \text{Total length of} & \times 0.021 \\ \Phi 6.35\text{mm} & \text{kg/m} \\ (\Phi 1/4\text{in.}) & (0.224 \\ \text{liquid pipe} & \text{oz./ft}) \\ \hline \text{m (ft)} & \\ \hline \text{kg (oz.)} & \end{array} = \begin{array}{|c|} \hline \text{Total} \\ \hline \text{kg (oz.)} \\ \hline \end{array}$$

<Example>

If liquid pipe piping length is the following

Φ9.52 (3/8") : 20m, Φ6.35 (1/4") : 15m

$$\begin{aligned} \text{Additional charge volume } L &= 20(\text{m}) \times 0.058(\text{kg/m}) + 15(\text{m}) \times 0.021(\text{kg/m}) \\ &= 1.475\text{kg} \approx 1.48\text{kg} \end{aligned}$$

Φ9.52 (3/8") : 78ft, Φ6.35 (1/4") : 110ft

$$\begin{aligned} \text{Additional charge volume } L &= 78(\text{ft}) \times 0.624(\text{oz./ft}) + 110(\text{ft}) \times 0.224(\text{oz./ft}) \\ &= 48.672\text{oz.} + 24.64\text{oz.} = 73.312\text{oz.} \approx 73.31\text{oz.} \end{aligned}$$

7.4. Refrigerant recovery method

※ Please perform the refrigerant recovery according to the local law and rules.

The refrigerant recovery of this type of equipment must be performed by a refrigerant recovery machine.

MODE/EXIT : Press the "MODE/EXIT" button.

SELECT : Press the "SELECT" button.

ENTER : Press the "ENTER" button.

- ① Turn on both the power supplies of the outdoor unit and the branch boxes.
- ② Press the "MODE/EXIT" button of the outdoor unit when all units are in stop operation state.
- ③ Match the 7 seg. display to "F3" by pushing the SELECT button.
- ④ Press the "ENTER" button.
- ⑤ Match the 7 seg. display to "21" by pushing the "SELECT" button.
- ⑥ Press the "ENTER" button for about 5 seconds.
- ⑦ Turn off the power supplies of all units when "P.oFF" is displayed.
- ⑧ Perform the refrigerant recovery with the refrigerant recovery machine.

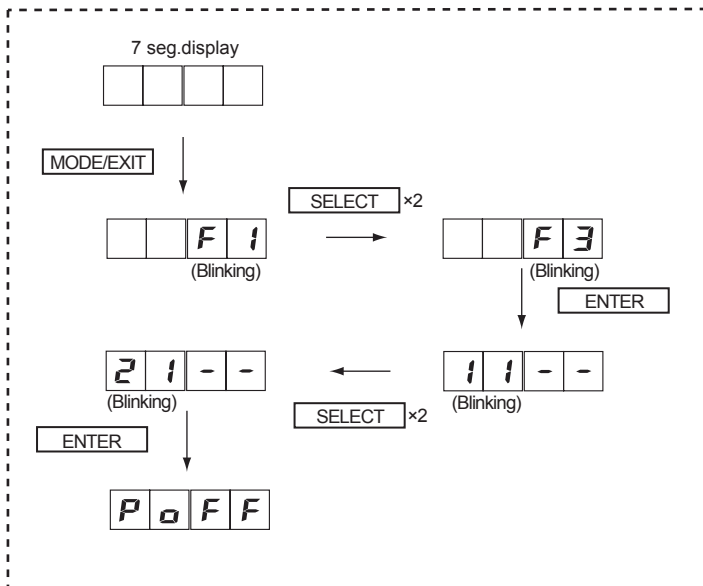

It can not be operated in the "P.oFF" state.

Please turn on the power supplies of all units again in case of performing operation.

7.5. Installing insulation

- Use an insulation on the refrigerant pipes to prevent condensation and dripping.
- Determine the thickness of the insulation material by referring to Table A.

Table A, Selection of insulation
(for using an insulation material with equal heat transmission rate or below 0.040 W/(m·k))

Relative humidity [mm (in.)]		Insulation material			
		Minimum thickness [mm(in.)]			
		70% or more	75% or more	80% or more	85% or more
Pipe diameter	6.35 (1/4)	8 (5/16)	10 (13/32)	13 (16/32)	17 (21/32)
	9.52 (3/8)	9 (11/32)	11 (7/16)	14 (18/32)	18 (23/32)
	12.70 (1/2)	10 (13/32)	12 (15/32)	15 (19/32)	19 (3/4)
	15.88 (5/8)	10 (13/32)	12 (15/32)	16 (5/8)	20 (25/32)

- If the ambient temperature and relative humidity exceed 32 °C (89°F), increase the level of heat insulation for the refrigerant pipes.

7.6. Filling with putty

⚠ WARNING

- Fill the piping holes with putty (supplied locally) to avoid any gap (Fig A). If small animals such as insects enter the external unit, a short circuit may be caused near electrical components in the service panel.

- If the outdoor unit is installed at a level that is higher than the indoor unit, the water that has condensed in the 3-way valve of the outdoor unit could travel to the indoor unit. Therefore, use putty in the space between the pipe and the insulation to prevent the entry of water to the indoor units.

Fig. A

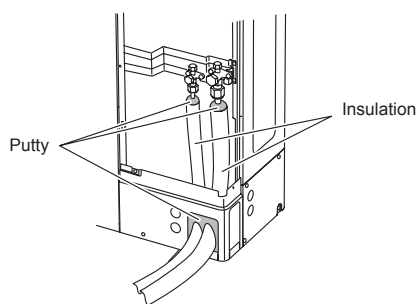

8. FIELD SETTING

⚠ CAUTION

Discharge the static electricity from your body before setting up the DIP switches.
Never touch the terminals or the patterns on the parts that are mounted on the board.

8.1. Field setting switches

Set the functions of an outdoor unit with the push buttons (SW931, SW932 and SW933) while observing the 7 seg. display (LED961 and LED962) on the printed circuit board.

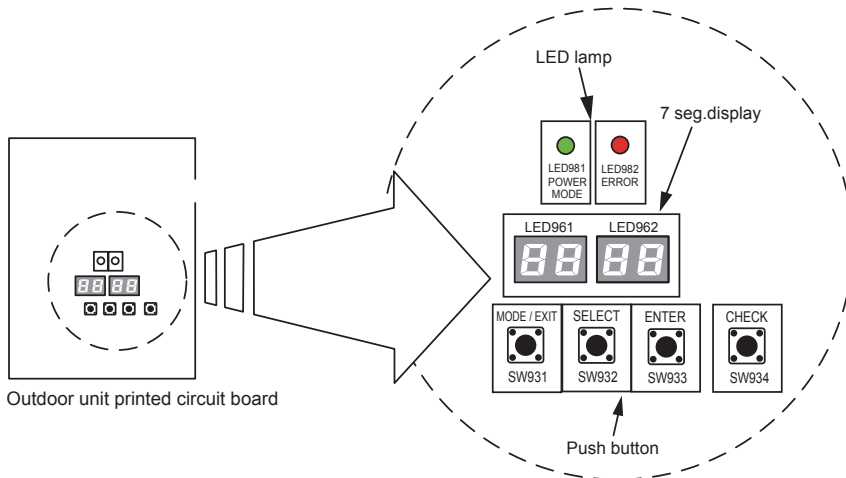

PREPARATION

- ① Be sure to check that the operation of the outdoor unit has stopped (be sure to stop the operation if it is still running), and turn off the power.
- ② Remove the front panel of the outdoor unit, and remove the lid of the electrical component box in order to expose the printed circuit board.
- ③ Turn on the power of the outdoor unit.
As shown in the above figure, make sure that the POWER/MODE indicator lamp (LED981) is on and the ERROR indicator lamp (LED982) is off.

- If the ERROR indicator lamp (LED982) flashes, it indicates that an error has occurred. Check wiring and power supply. After making sure that the ERROR indicator lamp (LED982) has turned off, proceed to the next step.

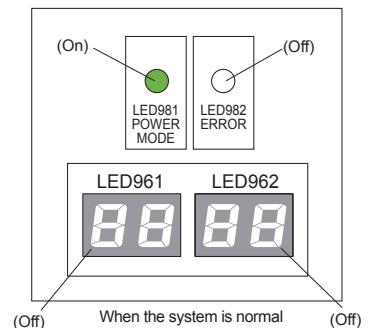

8.2. Function settings

Various functions can be set. Set when necessary.
Perform settings after all indoor units have stopped operation.

Refer to Table A for the items that can be set.

Table.A: List of Settings

No	Setting Item		7 seg				Factory default	Content
			First 2 digits		Last 2 digits			
11	Cooling capacity shift	Standard	1	1	0	0	●	<ul style="list-style-type: none"> Please set this item when cooling ability is inadequate. If cooling ability is inadequate due to the setting of "High power mode1", please set it to "High power mode2".
		High power mode1			0	1		
		High power mode2			0	2		
20	Switching between batch stop or emergency stop	Batch stop	2	0	0	0	●	<p>This mode selects the pattern of the stop function to be operated by the external input terminal (CN934).</p> <ul style="list-style-type: none"> Batch stop: The stop of all indoor units connected to same refrigerant system due to input signal coming from CN934. Emergency stop: The air conditioner returns to the original operation if input from the CN934 is stopped. Furthermore, the air conditioner does not accept the operation of the indoor unit when emergency stop is actuated.
		Emergency stop			0	1		
21	Operation mode selecting method	Priority given to the first command	2	1	0	0	●	<p>Select the priority setting of the operation mode.</p> <ul style="list-style-type: none"> Priority given to the first command: Priority is given to the operation mode which is set first. Priority given to external input of outdoor unit: Priority is given to the operation mode which is set by the external input terminal (CN932).
		Priority given to external input of outdoor unit			0	1		
28	Forbidden	Forbidden	2	8	0	0	●	Setting forbidden
29	Forbidden	Forbidden	2	9	0	0	●	Setting forbidden
					0	1		
30	Energy saving level setting	Level 1 (stop)	3	0	0	0		<p>The capacity limit can be selected when operating with the "Energy Saving Peak Cut function."</p> <p>The operation selection can be done by external input terminal(CN933).</p> <p>The lower the level, the more the effect of energy saving, but the cooling/heating performance decreases.</p>
		Level 2 (Limited at 50%)			0	1		
		Level 3 (Limited at 75%)			0	2	●	
		Level 4 (Limited at 100%)			0	3		
34	Frost Protection Fan Mode	On	3	4	0	0	●	<p>This mode is the function to prevent frosting to the propeller fan of outdoor unit during heating operation.</p>
		Off	3	4	0	1		
41	Low noise mode setting	Off (Normal)	4	1	0	0	●	<p>When "Low noise mode ON" is selected, the operating noise will be suppressed.</p> <p>Without external input terminal: It operates by selecting Low noise mode ON.</p> <p>With external input terminal: The operation selection can be done by external input terminal(CN931) by selecting Low noise mode OFF.</p>
		On (Low noise mode)			0	1		
42	Low noise mode operation level setting	Level 1 (-3dB)	4	2	0	0	●	<p>The noise level when operating in the low noise mode can be set.</p> <p>Cooling/heating performance decreases by lowering operation noise level.</p>
		Level 2 (-6dB)			0	1		
		Level 3 (-9dB)			0	2		

(1) Setting method

Use the MODE/EXIT, SELECT, and ENTER buttons to configure settings according to the procedures below.

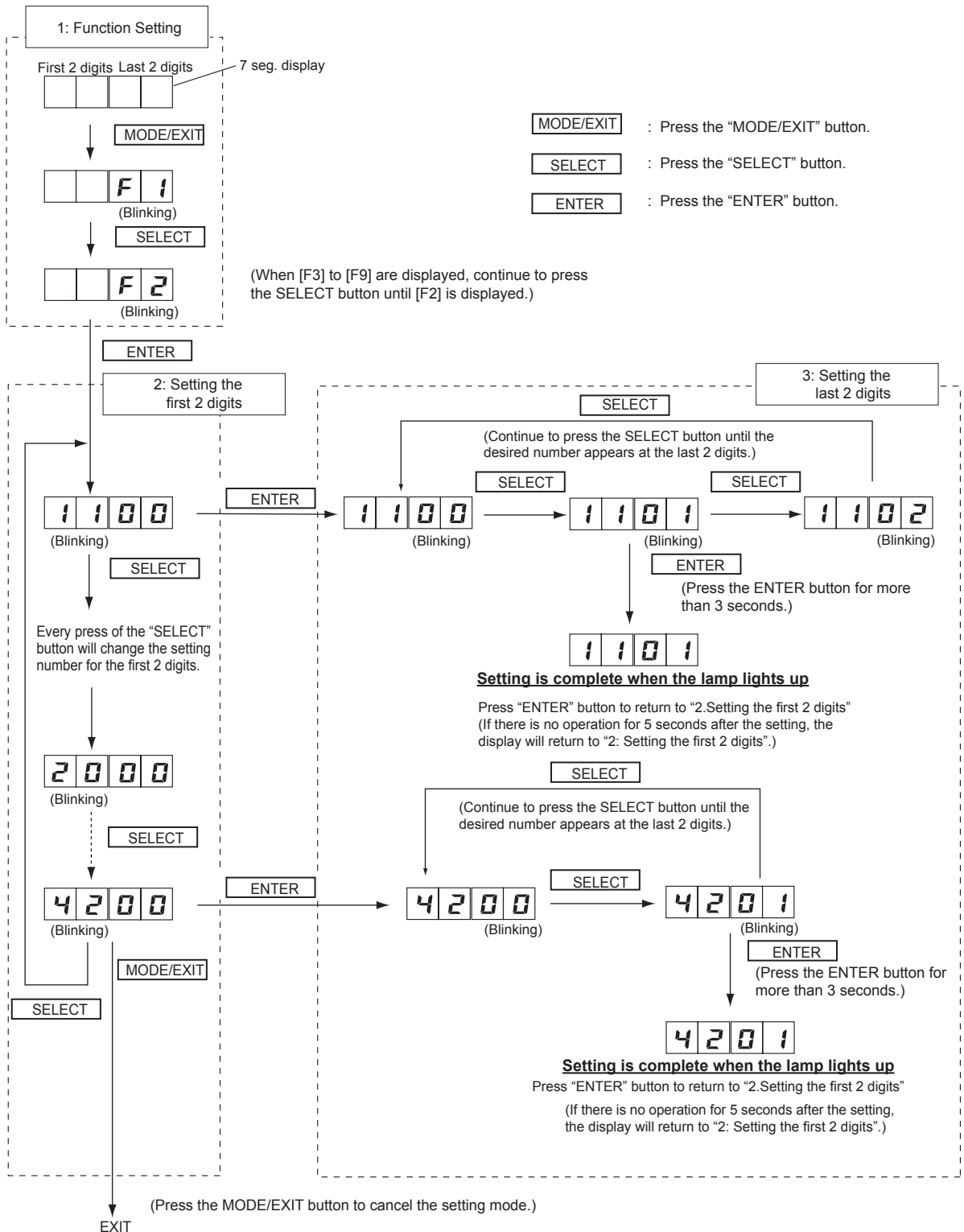

9. TEST OPERATION

9.1. Check run

After performing the repairs, inspections etc., always carry out the Check run. Normal operation will not be possible without performing the Check run.

9.1.1. Things to confirm before starting the Check run.

To ensure safety, check that the following work, inspections and operations have been completed.

Check Item	Check Column
① Check that all work on the piping connecting the outdoor unit, indoor units and branch box has been completed	
② Check that all work on the wiring connecting the outdoor unit, indoor units and branch box has been completed	
③ Is there a gas leakage? (At pipe connections {flange connections and brazed areas})	
④ Is the system charged with the specified volume of refrigerant?	
⑤ Is a breaker installed at the power supply cable of outdoor unit and every Branch boxes?	
⑥ Are the wires connected to the terminals without looseness, and in accordance with the specifications?	
⑦ Is the 3-way valve of the outdoor unit open? (Gas pipe and liquid pipe)	
⑧ Is power supplied to the crank case heater for more than 12 hours?	
⑨ Has the power supply of the all indoor units turned off ? (Remote controller)	

9.1.2. Restrictions applicable when performing the Check run

- When the Check run starts, all indoor units connected to the outdoor unit will start to run automatically. During the Check run, you cannot check the operation of the indoor units separately. After the Check run, check the operation of the indoor units separately in normal operation.
- The operable temperature ranges for the Check run are: external temperature -15 to 46°C(5 to 115°F); room temperature for cooling 18 to 46°C(64 to 114°F); room temperature for heating -15 to 37°C(5 to 98°F).
- In the check run, the conditioner will automatically switch between cooling and heating depending on the external temperature and internal temperature.
If the external temperature or internal temperature is outside the above operable temperature range, wait until the temperature is within the operable range and then perform the Check run.
- The Check run can be completed within 1 hour, but may take several hours depending on the external and internal temperature conditions etc.
- Please do not conduct the Check run with all the windows in the room closed. Otherwise the room temperature could get too low or too high.
- Depending on the difference of the room temperature of each room, a judgment may be impossible.

9. 1. 3. Operating procedure for Check run

(●: On, ◎: Blinking, ○: Off)

- (1) Turn power on to the outdoor unit, indoor units and branch boxes.
After the displayed number of "8888." has been turned off, press the "CHECK" button.(approximately 2 minutes)

- (2) Press and hold the "CHECK" button for more than 3 seconds.
(3) The number of connected branch boxes and indoor units will be displayed on the 7 seg. display. Check that the displayed number matches the actual number of connected units. Do not perform the Check run if the displayed number of units is in error. If the Check run was performed with the number of units in error, check the state of the units and then perform the Check run again.

- ① If the displayed number of units matches the installed number, go to (4)
- ② If the displayed number does not match the installed number, check the following.
 - Are all the Branch boxes turned on? → Check that the Branch boxes are turned on, and go to (4).
 - Are connection cables connected to all of the indoor units? → Turn of the power, connect the Connection cable and go to (1).

- (4) Press and hold the "CHECK" button again for more than 3 seconds.

- The Check run will start.

In the Check run, the following items will be checked.

- ① The wiring and piping between the indoor units and the Branch box
- ② Valve opening
 - To make an enforced stop, press the "MODE/EXIT" button. You cannot execute the stop operation using the remote control.
 - To prevent electric shock, close the service panel during the Check run.

- (5) The Check run will stop automatically after all items are completed.





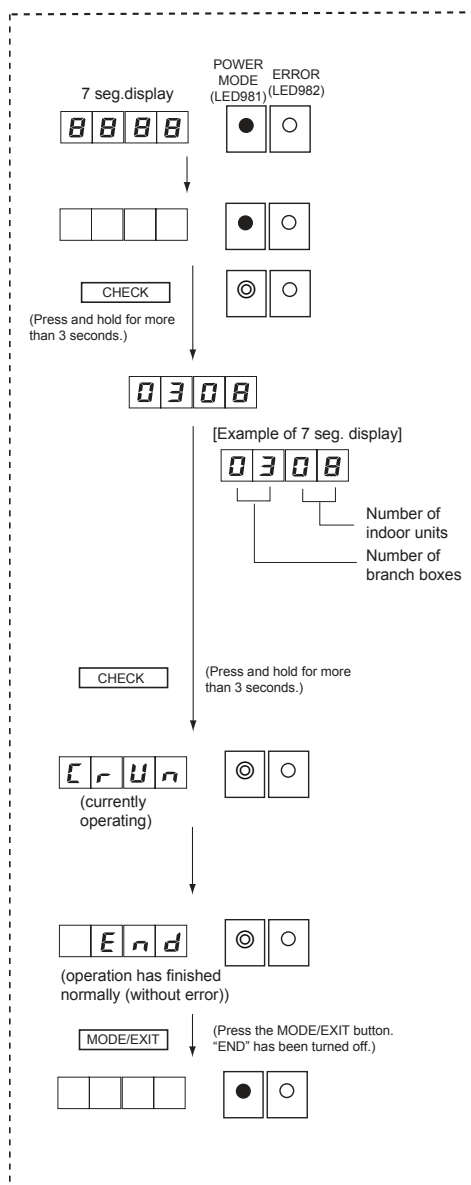



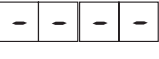

When an error occurs, consult the following error display items. Correct the error, and carry out the Check run again.

- * When the error display appears even though the measures for error are taken, switch on the power again after turning off the power. When the power is turned on again after turned off, wait approx. 10 minutes and turn on the power again.

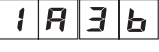

9. 1. 4. Error display

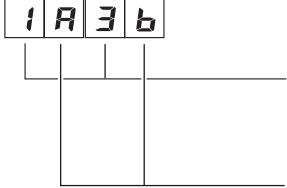
(●: On, ◎: Blinking, ○: Off)

Error display		Error item	Contents
7 seg. display	LED lamp		
 <p>(blinking)</p>		Indeterminable	The external or room temperature is outside the operable range. The air conditioner will temporarily permit normal operation, but the Check run should be carried out again at a later date when the temperatures are within the operable ranges.
		Wiring number error	The number of wirings between indoor unit and branch box is not correct. Turn off all the units, and check number of connected wires. After correcting the error, turn on the power and carry out the Check run again.
		Pipe number error	The number of wirings between indoor unit and branch box is not correct. Turn off all the units, and check number of connected pipes. After correcting the error, turn on the power and carry out the Check run again. ※ If the number of pipes is correct, the internal heat-exchanger thermistor or branch box piping thermistor may have come out of its holder, or a coil may have come out of an expansion valve. In this case, please contact Service personnel.
<p>(example)</p> 		Wiring error	<p>A wiring error has occurred.</p> <p>The location at which the wiring error has been determined will be displayed on the 7 seg. display. If there are multiple wiring error locations, the display will cycle through the locations, switching every 2 seconds. After performing the following operation, turn off the power and correct the wiring.</p> <ul style="list-style-type: none"> • Note down the content of the wiring error. • Note down the number of blinks of the green LED on the PCB of the branch box. <p>(The number of blinks indicates the device number of the Branch box)</p> <p>After correcting the wiring, turn on the power and carry out the Check run again.</p> <p>(In the case of the diagram)</p> <p>Connect the Connection cable which is connected to the terminal A on Branch box (Primary) to the terminal B on Branch box (Secondary2).</p>  <p>1: Branch box-Primary 2: Branch box-Secondary 1 3: Branch box-Secondary 2 A: Branch box-TerminalA b: Branch box-TerminalB C: Branch box-TerminalC</p>
		unit error	This is a unit error. * For error content, please refer to “11.2. Error display mode”.

9.2. TEST RUN

9.2.1. Pre-test run check items

Before the test run, refer to the figure and check the following items.

- ① Is check run performed? Test run doesn't operate if check run is not performed. ("FAIL" is displayed when operating the unit before the check run is done.)



After checking that the above items are all in order, refer to "9.2.2. Test run method" to test run the unit.

If there are problems, adjust immediately and recheck.

9.2.2. Test run method

Be sure to configure test run settings only when the outdoor unit has stopped operating.

- Depending on the communication status between the indoor and outdoor units, it may take several minutes for the system to start operating after settings for the test run are complete.
- After the test run settings are complete, all the outdoor units and the connected indoor units will start operating. Room temperature control will not activate during test run (continuous operation).
- Test run set with the outdoor unit doesn't stop automatically. Be sure to stop the operation according to the operation method.
- All indoor units will operate when test run is performed from the outdoor unit. At this time, the remote controller of the indoor unit is unavailable.
- Operation mode cannot be changed during the test run. To change the operation mode, please stop the test run first, and then perform the test run again. At this time, the compressor cannot be restarted for 3 minutes after it stops in order to protect the indoor unit. Please restart it after 3 minutes.

Perform test run for refrigerant system.

You can set "cooling test run" or "heating test run" with the push-button switch on the outdoor unit print circuit board.

Test run setting method

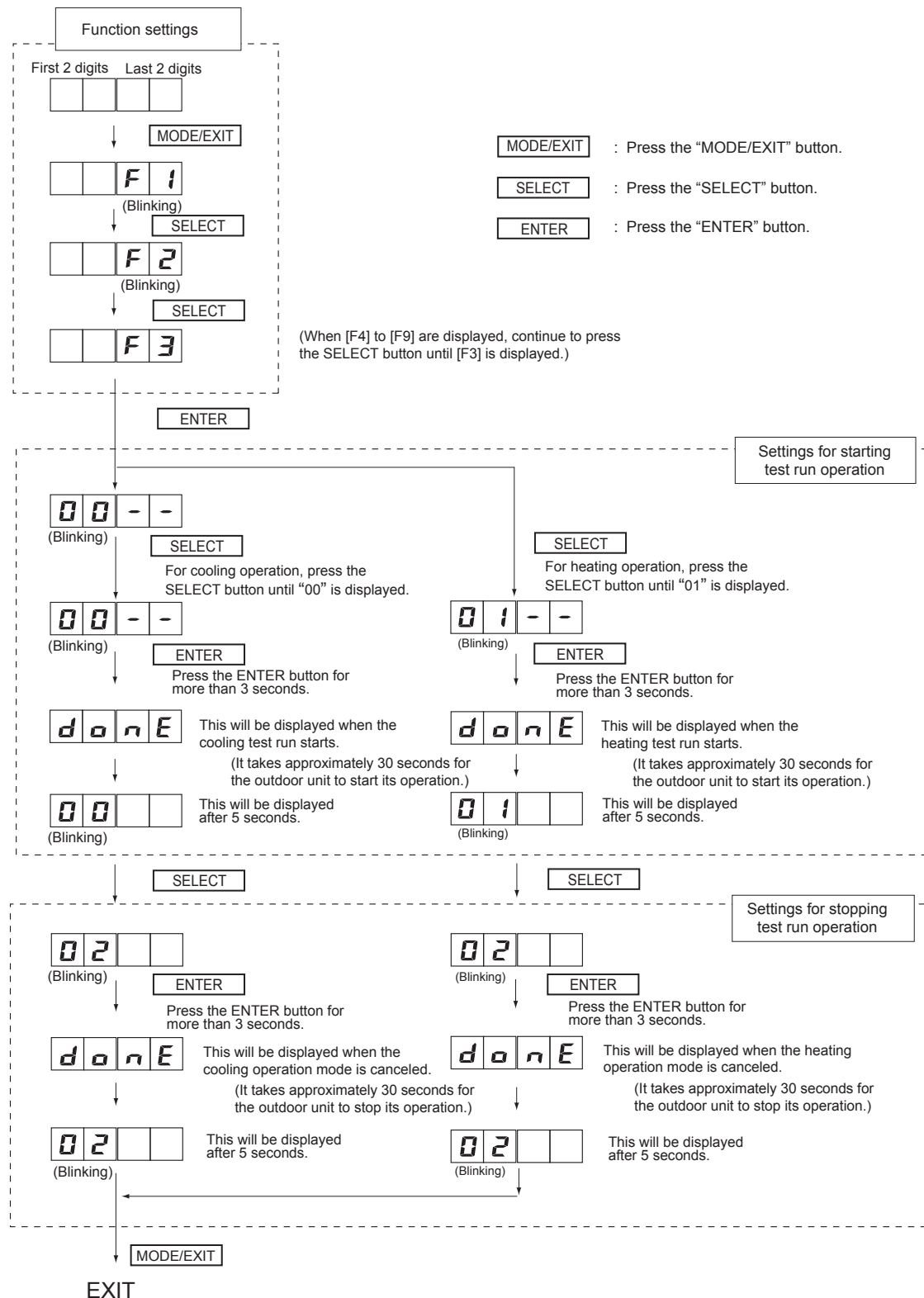

After the test run is complete, turn off the power. Attach the cover of the electrical component box and the front panel of the outdoor unit.

9. 3. Confirming the operation of indoor unit

Run the unit in a normal way, and confirm its operation. (Please end the check run first before confirmation)

- ① Cold air (or warm air) must be discharged from the indoor unit.
- ② The indoor unit operates normally when air direction or air volume adjustment button is pressed.

Error code is displayed when operating the indoor unit with the remote controller before check run.

10. EXTERNAL INPUT & OUTPUT

10. 1. Fitting cable (option parts)

The cable (including connector) that connects to the external input & output terminal is an optional part. This cable should not be laid parallel to the connection cable or power supply cable. Doing so could result in erroneous operation.

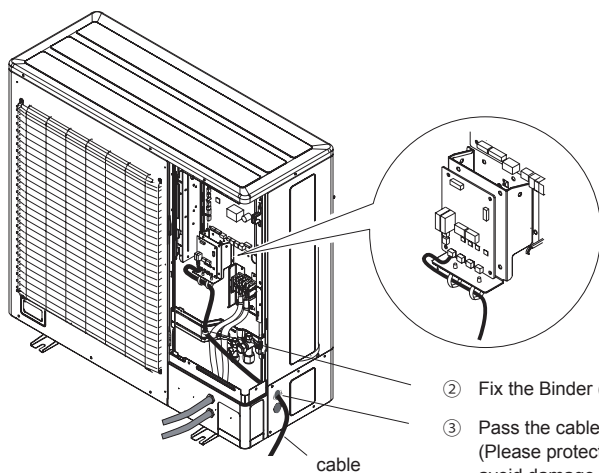

- ① When fitting the service cover, pull the cable as shown in the diagram to prevent it from being trapped. And fix the 2 binders (accessory (optional parts)).

- ② Fix the Binder (accessory (outdoor unit)).
- ③ Pass the cable through the as yet unused knockout hole. (Please protect the cable with the edge of knockout hole to avoid damage.) Seal the knockout hole that passes the cable with putty, so that there is no gap.

10. 2. External input

10. 2. 1. Wiring of connector

ON/OFF of the "Low noise mode", "External input priority mode", "Peak cut mode", and "Stop operation mode" functions can be enabled with an external field device.

When installing connection cable, specified part (optional parts) must be used.

Refer to section 8.2, Table. A: List of setting, for the required function. The function must be set for the external input to work.

Input	Connector
Low noise mode	CN931
External input priority mode	CN932
Peak cut mode	CN933
Stop operation mode	CN934

* Make the distance from the PC board to the connected unit within 10m (33ft).

- Contact capacity : 24VDC or more, 10mA or more.

Circuit diagram example

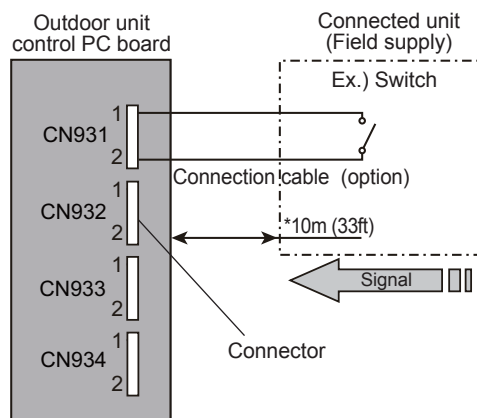

10. 2. 2. Low noise mode (CN931)

- This features reduces the operating sound of the outdoor unit from the normal sound. The air conditioner is set to the “Low noise mode” when closing the contact input of a commercial timer or ON/OFF switch to a connector on the outdoor control PC board.
- * Performance may drop depending on the outside air temperature condition, etc.
- * Set the “Low noise mode” level, refer to “8.2.Function settings”.

Input Signal ...ON : Low noise mode
 ...OFF : Normal operation

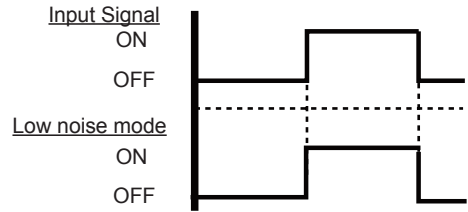

10. 2. 3. External input priority mode (CN932)

- It is possible to switch to cooling operation and heating operation by using external input.
- * Set the “External input priority mode” , refer to “8.2.Function settings”.

Input Signal ...ON : Heating operation
 ...OFF : Cooling operation

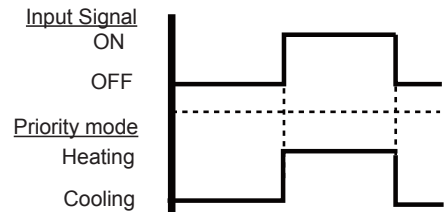

10. 2. 4. Peak cut mode (CN933)

- Operation that suppressed the current value can be performed by means of the connected unit. The air conditioner is set to the Peak cut mode by applying the contact input of a commercial ON/OFF switch to a connector on the outdoor control PC board.
- * Set the “Peak cut mode” level , refer to “8.2.Function settings”.

Input Signal ...ON : Peak cut mode
 ...OFF : Normal operation

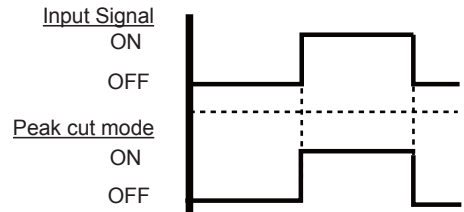

10. 2. 5. Stop operation mode (CN934)

- It is possible to switch to Batch stop or Emergency stop and Normal operation by using external input.
- * Set the “Batch stop” or “Emergency stop” pattern ,refer to “8.2.Function settings”.

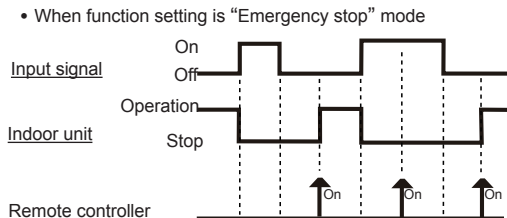
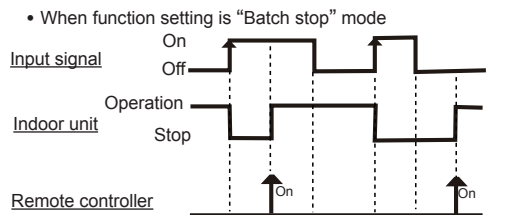

10.3. External output

10.3.1. Wiring of connector

When installing connection cable, specified part (optional parts) must be used.

Output	Connector
Error status	CN951
Compressor status	CN952

* Make the distance from the PC board to the connected unit within 10m (33ft).

- 1) Power supply
 - Voltage (Chart sign=Vcc) : DC 24V or less
- 2) Load
 - Load : DC 500mA or less is recommended

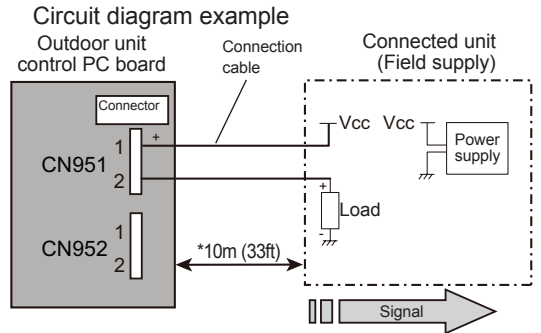

10.3.2. Error status output (CN951)

An air conditioner error status signal is produced when a malfunction occurs.

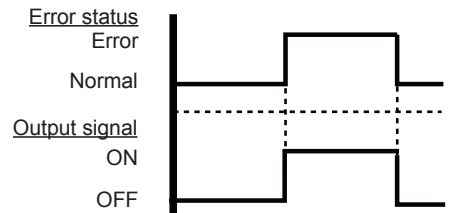

10.3.3. Compressor status output (CN952)

Compressor operation status signal is produced when the compressor is running.

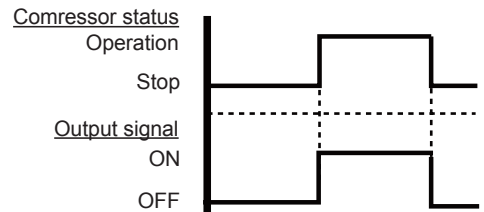

10.3.4. Base heater

A Base heater is a heating element that may be installed to melt the ice that may accumulate in the condenser, drain pan.

When installing connection cable, specified part (optional parts) must be used.

This output signal is produced when the outdoor temperature drop down to 2°C (36°F), and releases at 4°C (39°F).

Circuit diagram example

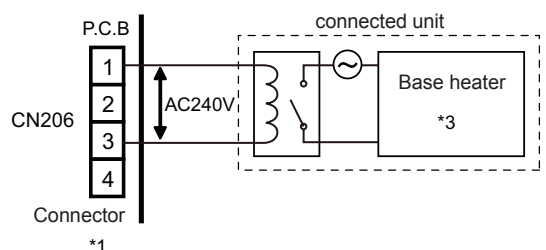
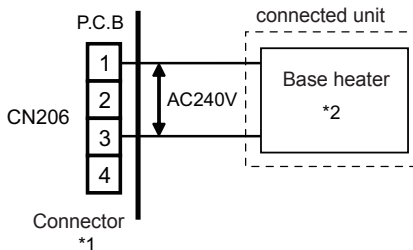

*1: Connect to pin 1 and pin 3. No connection pin 2 and pin 4.

*2: The allowable power consumption is 25W or less.

*3: If a load greater than 25W is applied, a contactor or relay should be used to operate and control the base heater.

11. LED Display

You can determine the operating status by the lighting up and blinking of the LED lamp.
Check the status using the table below.

11. 1. Normal operation mode

CODE		DESCRIPTION
C	L	Cooling
H	t	Heating
	o r	During oil recovery operation
	d F	During defrosting operation
	P C	During power saving operation
	L n	During low noise operation

11. 2. Error display mode

- When error occurs, "Err" and "Number of errors occurred" are alternately displayed on the 7 seg. display.
- The latest error code can be confirmed by pressing the ENTER button.
- When error codes are displayed, all the error codes can be confirmed by pressing the SELECT button.
- When the error display appears even though the measures for error are taken, switch on the power again after turning off the power. When the power is turned on again after turned off, wait approx. 10 minutes and turn on the power again.

Example: When "Discharge thermistor error" and "Compressor thermistor error" occurred

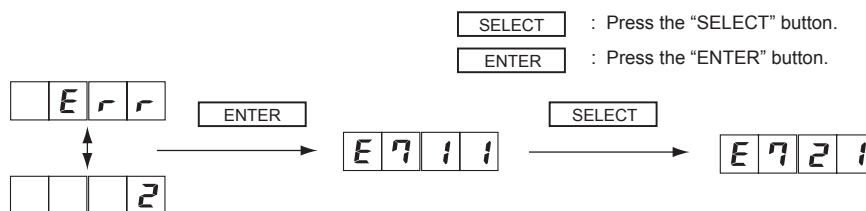

CODE	DESCRIPTION	CODE	DESCRIPTION
E 1 1 1 3	Serial communication error	E 7 5 1	Suction gas thermistor error
E 1 1 1 4		E 7 7 1	Heat sink thermistor error
E 1 5 6	Check run unfinished	E 8 2 1	Sub-cool heat EX gas inlet thermistor error
E 2 1 2	Number of wires and pipes error	E 8 2 2	Sub-cool heat EX gas outlet thermistor error
E 2 2 1	Indoor unit capacity error	E 8 3 1	Liquid pipe thermistor error
E 2 4 2	Number of indoor units error	E 8 4 1	Current sensor error
E 2 4 3	Number of Branch boxes error	E 8 6 1	Discharge pressure sensor error
E 5 U 1	Indoor unit error	E 8 6 3	Suction pressure sensor error
E 6 2 1	Outdoor unit model information error	E 8 6 4	High pressure switch error
E 6 3 1	Inverter error	E 9 4 1	Over current error
E 6 4 1	A.F. voltage error	E 9 5 1	Compressor control error
E 6 5 3	I.P.M. error	E 9 7 3	Outdoor unit fan motor error
E 6 A 1	Display P.C.B. communication error	E 9 9 1	4-way valve error
E 7 1 1	Discharge thermistor error	E A 1 1	Discharge temp. error
E 7 2 1	Compressor thermistor error	E A 3 1	Compressor temp. error
E 7 3 3	Heat EX. liquid outlet thermistor error	E A 5 1	Low pressure error
E 7 4 1	Outdoor thermistor error	E J 2 U	Branch boxes error

Note : Even if error is solved while displaying error codes, the 7 seg. display continues to display the error codes.
Please confirm the error has been recovered by checking normal display.

7 seg. display:

1: 1, 2: 2, 3: 3, 4: 4, 5: 5, 6: 6, 7: 7, 8: 8, 9: 9, A: A, B: b, C: C
 d: d, E: E, F: F, H: H, J: J, L: L, n: n, o: o, r: r, t: t, S: S, P: P
 U: U