

**RESIDENTIAL SPLIT SYSTEM HEAT PUMP
FSH1BF4M2SX SERIES
16 SEER MODELS**

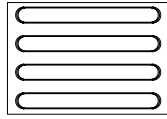

Corner Post Style



Panel Style

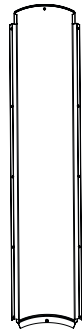
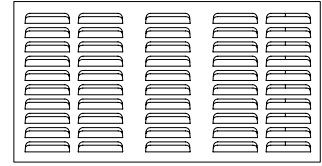

Corner Post

Outdoor Fan Grille

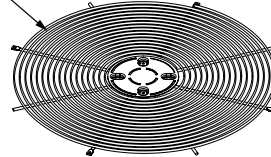

Outdoor Fan Motor

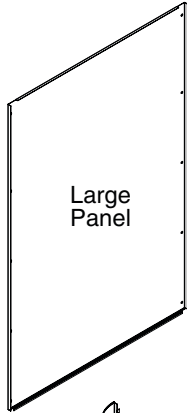
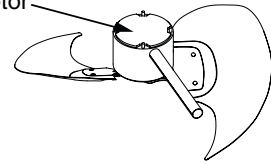

Large Panel

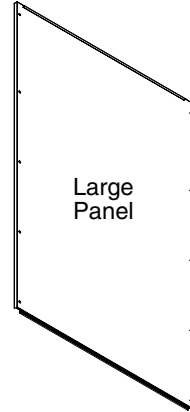

Large Panel

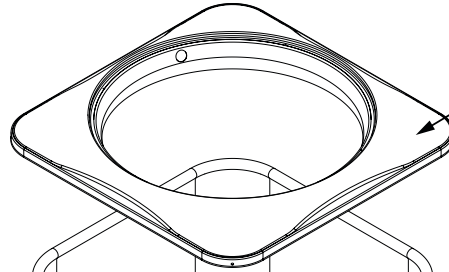

Top Pan

Corner Post



Corner Post

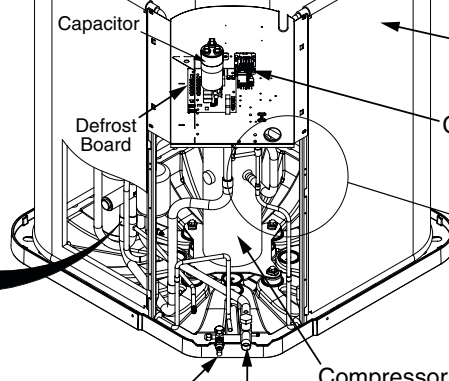
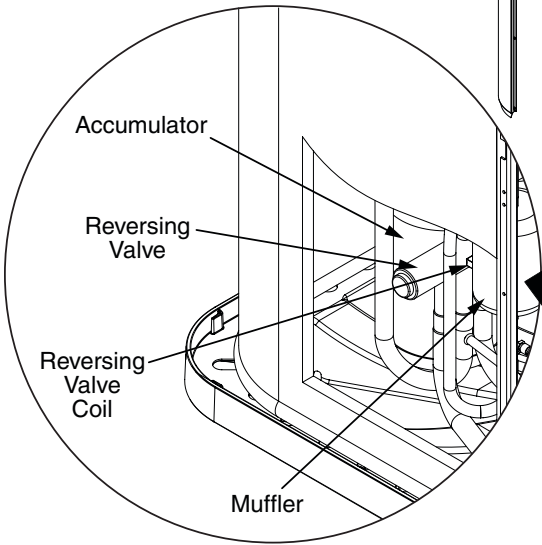

Capacitor

Defrost Board

Outdoor Coil

Contactor

Compressor

Refrigerant Valve (SM)

Refrigerant Valve (LG)

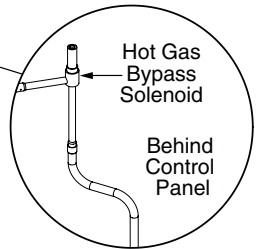

Hot Gas Bypass Solenoid

Behind Control Panel

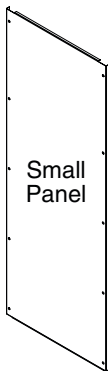

Small Panel

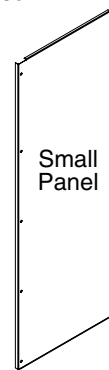

Small Panel



Left Back Post

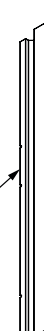

Right Back Post

FSH1BF4M2SX SPLIT SYSTEM HEAT PUMP WITH MICROCHANNEL

COMPONENT	FSH1BF4M2SX24K	FSH1BF4M2SX36K	FSH1BF4M2SX48K	FSH1BF4M2SX60K
	1014235F	1014236F	1014237F	1014238F
ACCUMULATOR	668853R	668794R	668854R	668854R
AMBIENT SENSOR	624780R	624780R	624780R	624780R
CAPACITOR	01-0083	01-0269	01-0262	01-0084
COMPRESSOR	921844	921769	921659	921793
COMPRESSOR MOLDED PLUG	634660R	634660R	634660R	634660R
COMPRESSOR PLUG, LV 2 STAGE	634661R	634661R	634661R	634661R
CONTACTOR	624826R	624826R	624827R	624828R
CRANKCASE HEATER	632410R	632410R	632410R	632410R
DEFROST BOARD	1016567R	1016567R	1016567R	1016567R
DEFROST SENSOR	624812R	624812R	624812R	624812R
FILTER DRIER	669762R	669762R	669761R	669761R
HIGH PRESSURE SWITCH	632473R	632473R	632473R	632473R
HOT GAS BYPASS COIL	669992R	669992R	669992R	669992R
HOT GAS BYPASS VALVE	669964R	669964R	669965R	669965R
LOW PRESSURE SWITCH	632393R	632393R	632393R	632393R
MUFFLER	669546R	669546R	669546R	669546R
OUTDOOR COIL	664832R	664907R	664909R	664909R
LARGE PANELS	101074204R	101074206R	101074206R	101074206R
SMALL PANELS	101074404R	101074406R	101074406R	101074406R
CORNER POST	101472304R	101472306R	101472306R	101472306R
LEFT BACK POST	101450404R	101450406R	101450406R	101450406R
RIGHT BACK POST	101450304R	101450306R	101450306R	101450306R
OUTDOOR FAN BLADE	667351R	667351R	667351R	667319R
OUTDOOR FAN GRILLE	669591R	669591R	669591R	669591R
OUTDOOR FAN MOTOR	622171R	622656R	622656R	622656R
REFRIGERANT VALVE (LG)	663864R	663865R	663865R	663865R
REFRIGERANT VALVE (SM)	664850R	664850R	664850R	664850R
REVERSING VALVE	669465R	M0079102	M0079102	M0079102
REVERSING VALVE COIL	669470R	669470R	669470R	669470R
SWIVEL NUT CONNECTOR	664194R	664194R	664194R	664194R
TOP CAP	275291	275291	275291	275291
TOP PAN	101472101R	101472101R	101472101R	101472101R
THERMOSTATIC EXPANSION VALVE	669770R	669771R	669568R	669578R

Please specify the correct Model No., Serial No., and part number(s) when ordering parts from the nearest authorized dealer or service center.

