

FKD 8 XL MIXED FLOW FAN

Item no. 40012

Document type: **Product card**
 Document date: **2018-06-15**
 Generated by: **Systemair Online Catalogue**

Description

- Mixed-flow impeller
- 100% Speed-controllable
- Integral thermal contacts
- Air stream temperatures up to 140 °F

Application

Fantech FKD direct drive, mixed flow fans blend the high air flow of axial fans with the higher pressure, non-overloading characteristics of backward curved impellers. An excellent choice for exhaust or supply applications where quieter performance and easy installation are important. Perfect for commercial and institutional structures such as offices, hospitals, beauty salons, veterinary clinics as well as residential applications such as kitchen range hood exhaust.

Design

The casing is manufactured from galvanized sheet metal. The Series have external rotor motors with a mixed flow impeller, which reduces the external dimensions of the fans. Brackets are supplied with the fans to make installation easier.

Motor protection

To protect the motor from overheating the fan has integral thermal contacts with leads to a motor protection device.

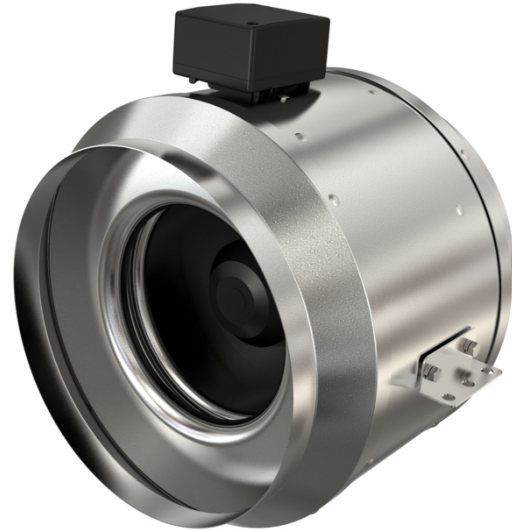

Technical parameters

Nominal data	
Voltage	115 V
Frequency	60 Hz
Phase	1 ~
Input power (P1)	318 W
Current	2,99 A
Max. airflow	837 cfm
Fan impeller speed	2599 r.p.m.
Weight	14,8 lbs.
Temperature data	
Max. temperature of transported air	140 °F
Protection / Classification	
Insulation class	B
Enclosure class, motor	IP44
Others	
Certificate	AMCA Air, AMCA Sound, cULus

EPS diagrams

Performance

Diagrams

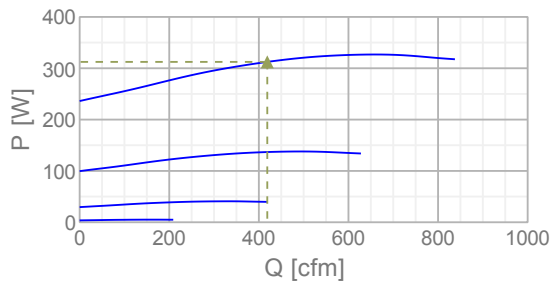
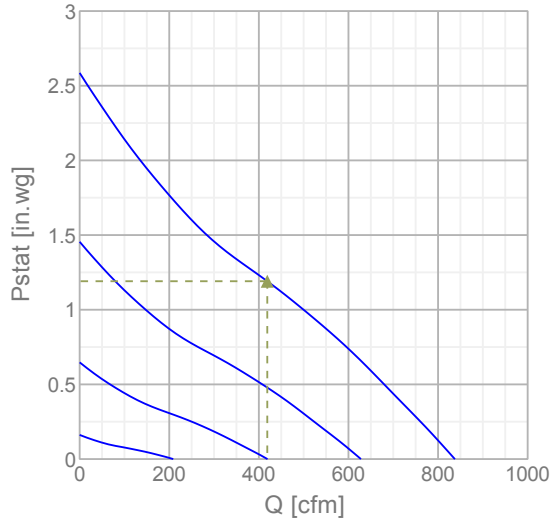

Max efficiency

Hydraulic data										
▲ Working air flow	419 cfm									
▲ Working static pressure	1,19 in.wg									
▲ Power	312 W									
Speed	2618 r.p.m.									
Current	- A									
SFP	0,746 W/(cfm)									
Voltage	115 V									
Sound power level	63	125	250	500	1k	2k	4k	8k	Tot	
Inlet	dB(A)									
	56	68	73	74	71	65	63	58	78	

Loudness

Dimensions

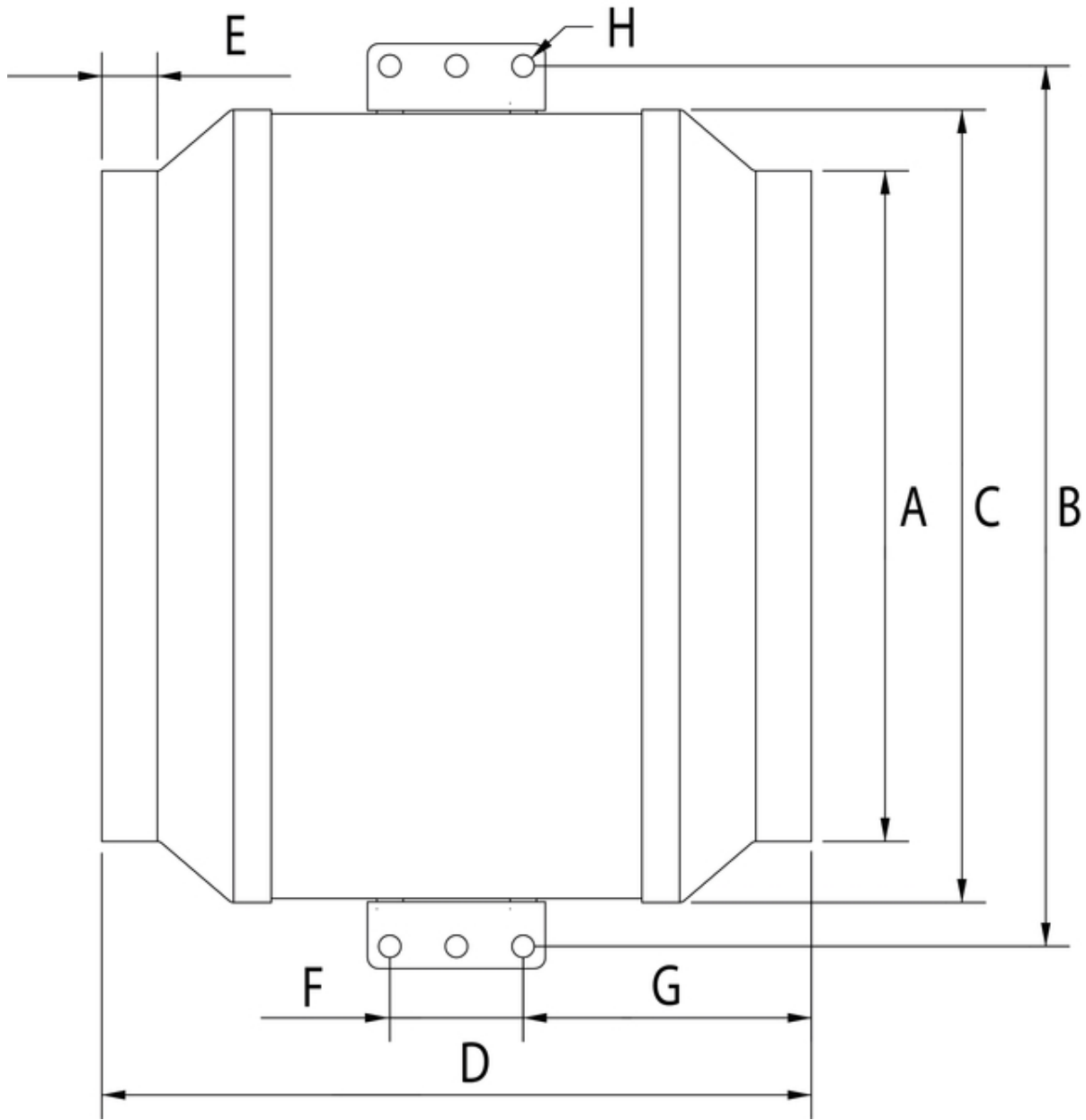

Model	A	B	C	D	E	F	G	H
8XL	8 (203)	14 (356)	12 1/2 (318)	14 5/8 (371)	1 (25)	2 3/8 (60)	6 1/8 (156)	3/8 (10)
10	10 (254)	14 (356)	12 1/2 (318)	12 1/4 (311)	1 (25)	2 3/8 (60)	5 (127)	3/8 (10)
10XL	10 (254)	15 5/8 (397)	14 (356)	15 (381)	1 (25)	2 3/8 (60)	6 3/8 (162)	3/8 (10)
12	12 (305)	15 5/8 (397)	14 (356)	12 1/2 (318)	1 (25)	2 3/8 (60)	5 1/8 (130)	3/8 (10)

Dimensions in inches (mm)

Wiring

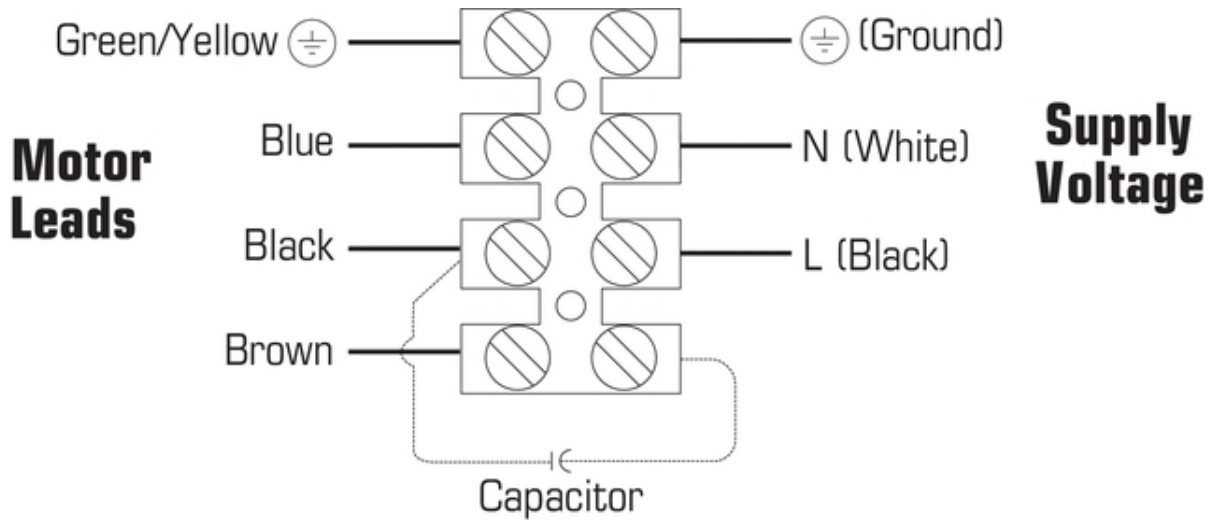

Accessories

Electric accessories

[RPE 10 Speed Control \(411101\)](#)

[WC 15 Speed Control \(411102\)](#)

Accessories

[FC 8 Mounting Clamps \(411121\)](#)

[LD 8 Silencer \(411125\)](#)

[IR 8 Iris Damper \(411237\)](#)

[RSK 8 Backdraft Damper \(411115\)](#)

[FML 8 Metal Hood Supply Air \(45148\)](#)

Documentation

 [401339 FKD OIPM EN FR ES.pdf \(1,05MB\)](#)

 [450368 FKD Submittal Sheet EN.pdf \(156,32kB\)](#)

 [450420 FKD Guide Spec EN.pdf \(69,80kB\)](#)

 [40012.dxf \(940,14kB\)](#)

Specification text

Description

A mixed flow centrifugal type exhaust/supply fan for moderate size ventilation applications specifically designed to bridge the transition from centrifugal to axial. FKD Series fans offer substantially quieter performance and are easier to install than axial arrangements. Fans can be mounted at any angle in any point along the duct work and straight-through air flow design allows easy installation. Fans can be easily removed from duct work for service. Fan motors are capable of operating in air stream temperatures of 140o F. Motor bearings are a permanently sealed, self lubricating ball type. All fans are 100% speed controllable through a decrease in the voltage by using a solid state or transformer type control. All FKD Series fans are backed by Fantech's Three Year Warranty.

Guide Specifications for Model FKD Inline Duct Fans

Supply, exhaust or return air inline fans shall be of the centrifugal, direct driven type.

Construction Housing

- Fan housing shall be constructed of heavy gauge galvanized sheet metal
- Fan shall be supplied with externally mounted electrical terminal box with pre-wired terminal strip connections

Motor

- Motorized impeller shall be an enclosed external rotor type. Single phase motors (FKD8XL – FKD18) shall be 120 or 230V permanent split capacitor type
- Three phase motors (FKD18XL, FKD20) shall be dual wound for 230V or 440/460V
- All motors shall be a permanently sealed self lubricating ball bearing type
- Single phase motors shall be equipped with automatic reset thermal overload protection
- Three phase motors shall be equipped with internal automatic reset thermal overload switch for interlock with contactor
- Motors shall be acceptable for continuous duty
- Sufficient service factor shall be provided to ensure long maintenance free operation over maximum load conditions

Wheel

- Fan wheel shall be of the mixed flow centrifugal type with a well designed inlet venturi for maximum performance
- Motorized impeller shall be both statically and dynamically balanced as one integral unit to provide for vibration free performance
- Impellers for models FKD 12XL through FKD18 shall be molded of high impact polypropylene
- Impeller for FKD 8XL through FKD 12, FKD 18XL and FKD 20 shall be constructed of aluminum

Performance

- Fan air flow and sound performance shall be based on tests conducted in accordance with AMCA Standard 211 and 311 and shall be licensed to bear the AMCA Certified Ratings label Code Approval
- Fan shall be tested and approved by UL and CSA (or equals) for safety

FKD Series shall be manufactured under the authority of Fantech, Inc., Lenexa, KS.