



Owner's Manual for models:

- Back Mount Undercounters** ETBR1, ETBSR2, ETBR2, ETBWR2, ETBR3, ETBF1, ETBSF2, ETBF2, ETBWF2, ETBF3
- Drawered Undercounters** ETBR1-D2, ETBSR2-D2, ETBR2-D4, ETBWR2-D4, ETBR3-D2
- Side Mount Undercounters** ETR1, ETR2, ETWR2, ETR3
ETF1, ETF2, ETWF2, ETF3, ETRF2, ETRF3
- Side Mount Glass Door Undercounters** ETGSR2, ETGR2, ETGWR2

A Step Above the Standard



Thank you for choosing EVEREST

Safety Notices



EVEREST
REFRIGERATION



WARNING - When using your appliance, always follow basic precautions, including the following :

When installing the unit, be careful that the electrical cord is not under the unit or pressed against the wall. This could cause a damage to the cord.

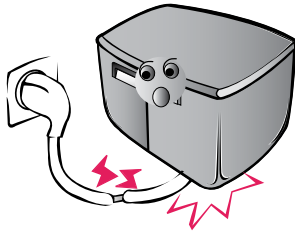

Before starting the unit for the first time, make sure the unit is free from all packaging. Packaging left on the unit during operation may cause a fire hazard.

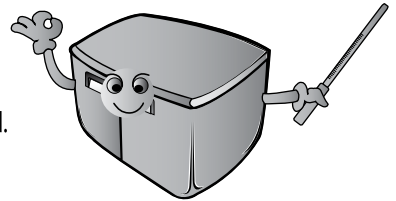

To prevent electrical shock, please do not plug or unplug the cord with wet hands.

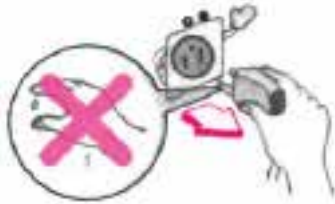

Before cleaning or maintaining the unit, please unplug it. Do not use any flammable cleaning products on or around the unit.

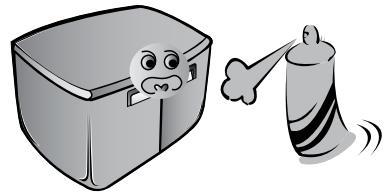

Install the unit on a hard and level surface.

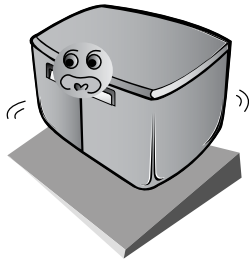

Please do not hang or climb on the unit as this may cause the unit to fall.



Please do not store temperature sensitive items in the unit, such as medical or science research related materials.

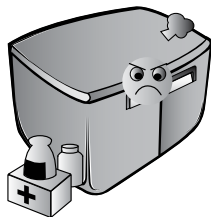

If you suspect a refrigerant leak, unplug the unit and immediately contact an authorized service technician.





WARNING - Read and follow all safety notices in this installation guide. These notices provide helpful safety and efficient operation information. Failure to do so may lead to serious injury and / or damage to the unit.

To minimize shock and fire hazards, be sure not to overload the outlet into which the unit is plugged into. A dedicated circuit of sufficient amperage is required.

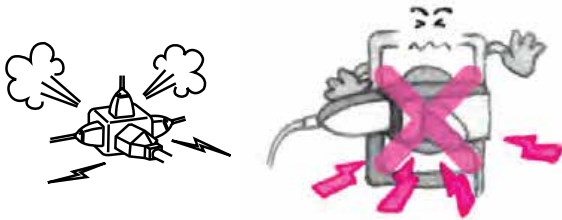

To prevent damage to the electrical components, have the unit plugged in directly to its own circuit. EVEREST is not responsible for any damage caused by improper electrical connections resulting from electrical power failure, use of extension cords & surge protectors, and any voltage drops to the unit.

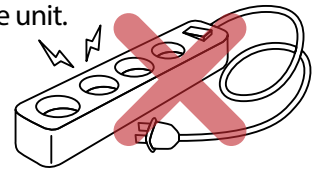

To prevent electrical shock and malfunction, do not spray the unit with water.

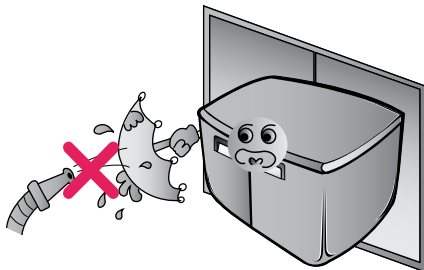

Clean the pronges of the electrical plug with a soft cloth or brush before plugging it into an electrical receptacle to prevent a fire hazard.



When it is time to salvage the unit, make sure to remove the rubber gaskets from the doors to prevent the risk of children or animals getting trapped inside the unit.

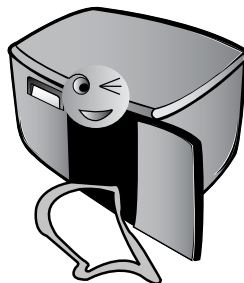

To prevent electrical shock and damage to the electrical cord, please hold the plug head when plugging and unplugging the unit.



Do not use the electrical cord or plug if they are damaged in any way.



To avoid personal injuries from broken glass, please do not place glass items in the freezer.



Avoid installing the unit where it could be exposed to water or moisture.

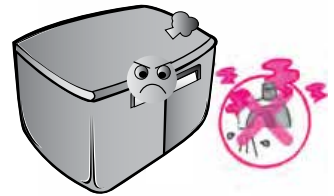

After unplugging the unit, please wait at least 6 minutes before re-plugging it in. Failure to do so could cause extensive damage to the compressor.

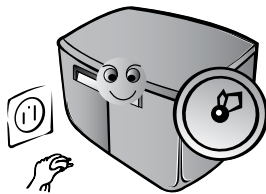

Avoid touching frozen foods or containers, especially metal containers, with wet hands. It could cause frostbite.



If the unit will not be used for an extended period of time, please unplug it from the outlet.



Please do not attempt to remove or repair any components unless you are an authorized service technician.

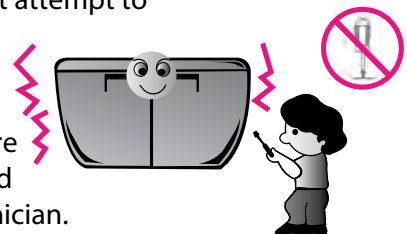

The refrigerator compartment temperature should be set from 32°F~42°F. The freezer compartment temperature should be set from -5°F~5°F (See page 10, 11). Setting the temperature out of the recommended ranges will void the unit's warranty.

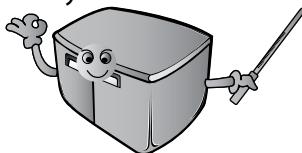

Do not put your hands under the unit when moving it. You could be injured by sharp edges, protruding parts, crushing, etc.



Install the unit on a hard and level surface or the unit could produce undesired noises.

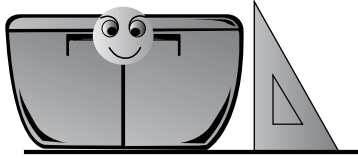

The unit should be at least 2" away from the wall and the casters must be installed for ventilation and proper operation of the condensate evaporative system. For the side mount units, a 7" space should also be afforded to the left side of the unit.

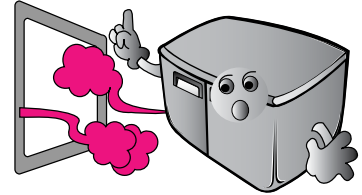

Indoor Use Only

Outdoor use may cause a decrease in performance and significant damage to the unit.

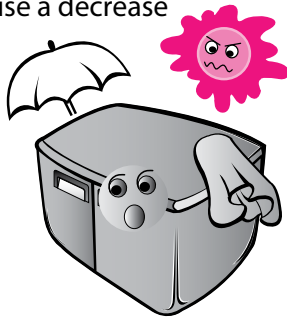

Dusty and High Humidity Areas

Dusty environments will cause the condenser coil to prematurely clog which will require it to be cleaned more often. High humid environments could cause the unit to rust.

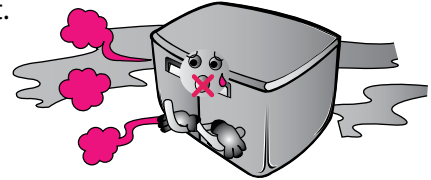

Do not build an enclosure or cabinet around the unit.

Restricting the airflow around the unit's condenser area will cause the compressor to work harder, which can result in compressor failure and the unit not being able to maintain the desired temperature.

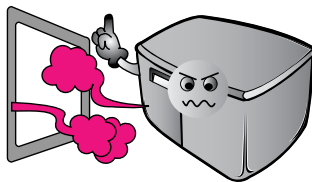

Select a location away from other heat and moisture generating equipment such as stoves, ovens, dish washers, etc.

High ambient temperatures cause the compressor to work harder, which can result in compressor failure and the unit not being able to maintain the desired temperature.

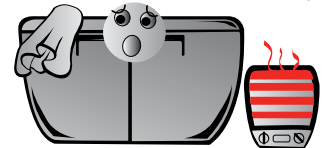

Keep the unit upright at all times during delivery. Tilting the unit during delivery will cause harm to the refrigeration system.

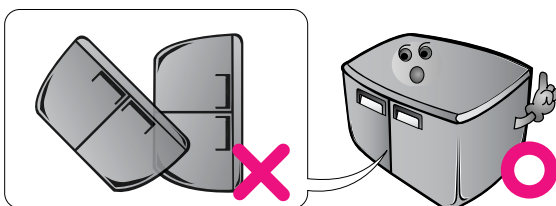



Shelf Cleaning

Periodically remove the shelves from the unit and clean them with mild soap and warm water.

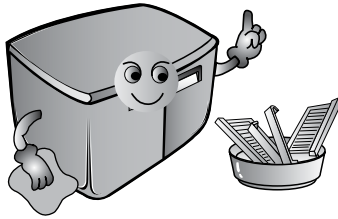

Door Gasket Cleaning

To preserve the life span of the door gasket clean the gasket with mild soap and water on a regular basis.

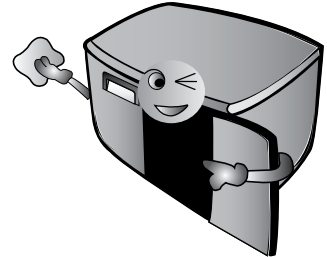

Do not use the following products when cleaning

Clean the exterior of the product with a stainless steel cleaner only. Never use steel wool, strong acids, abrasive cleaners or degreasers. Acidic products and products containing vinegar must be stored in sealed containers to prevent acid damage to the interior of the unit and the evaporator coil. (Rust resulting from the lack of or improper maintenance will not be covered under warranty.)

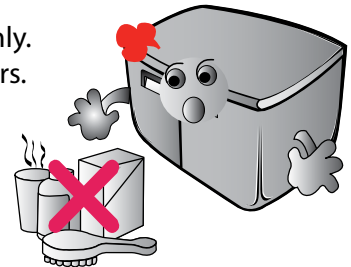

Interior Cleaning

Clean the interior surface of the unit with mild soap and warm water. Do not let water accumulate inside the unit. To prevent water damage, wipe the interior of the unit with a dry cloth as needed. Do not use abrasive cleaners, concentrated detergents, bleaches, cleaning waxes, solvents or polishes to clean the interior of the unit.

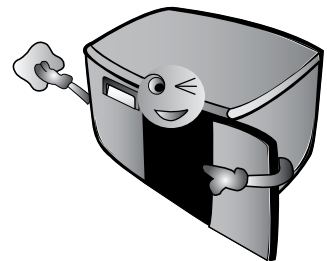

Condenser Coil Cleaning

Poor condensing unit performance is caused by heavy dust build-up on the condenser coil. The condenser coil should be cleaned monthly. Shine a flashlight through the condenser coil to check for dirt between the fins. Clean the outside of the condenser with a soft brush or a vacuum with a brush attachment. The condenser coil should be cleaned in the direction of the fins, top to bottom, not side to side. Be careful not to bend the fins. Detailed instructions of this procedure can be found on page 13 in this manual.

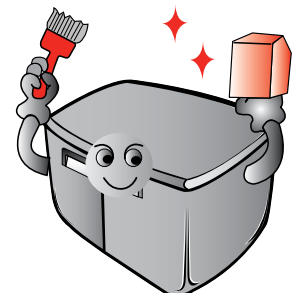

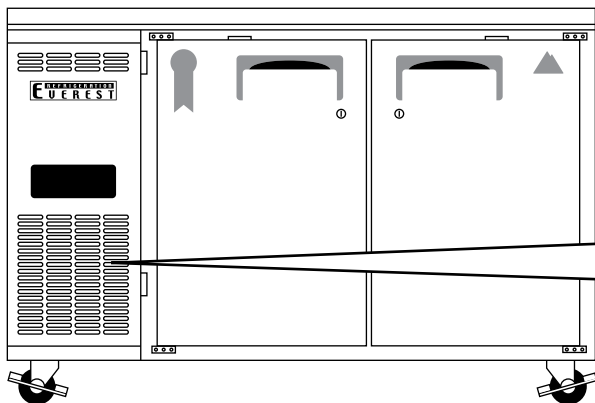

Diagram ET-L-001-D1

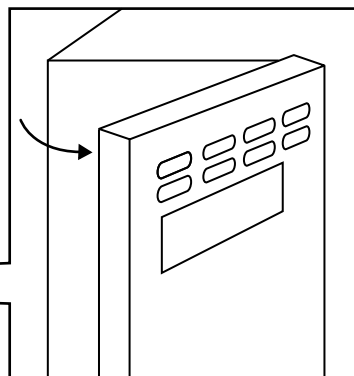

Diagram ET-L-001-D2

ET Series

Applicable Model Prefix: ET

Model Shown: ETF2

IMPORTANT: Failure to clean the condenser coil will result in a void of warranty.

Follow these simple steps at least once a month to ensure the proper operation of your Everest product.

1. Always unplug the unit before performing maintenance.
2. Locate the condensing unit panel door at the front, left side of the unit. See diagram ET-L-001-D1.
3. Open the condensing unit panel door to access the condenser coil. See diagram ET-L-001-D2.
4. Take note of two possible locations of the condenser coil black mesh air filter.
Type (A) air filters will be mounted in front of the condenser coil. Type (B) air filters will be mounted behind the condensing unit panel door. See diagrams ET-L-001-D3 and ET-L-001-D4.
5. Completely detach the air filter from the mounting brackets. See diagrams ET-L-001-D3 and ET-L-001-D4.
6. Rinse air filter in lukewarm water and soap solution*.
7. Repeat step 6 until air filter is clear of any blockage from lint, dust or grease.

* Do not use abrasive, acid-based cleaners or degreasers to avoid damage to the air filter.

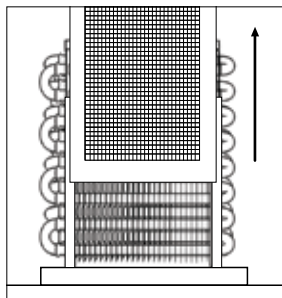
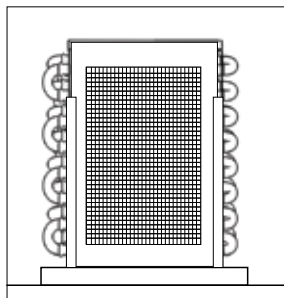

A type

Diagram ET-L-001-D3

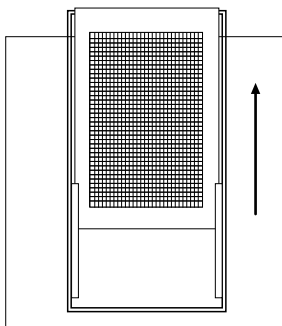
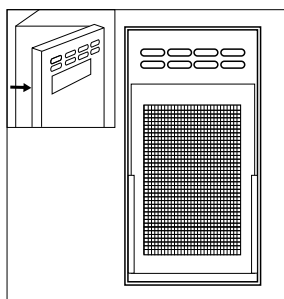

B type

Diagram ET-L-001-D4

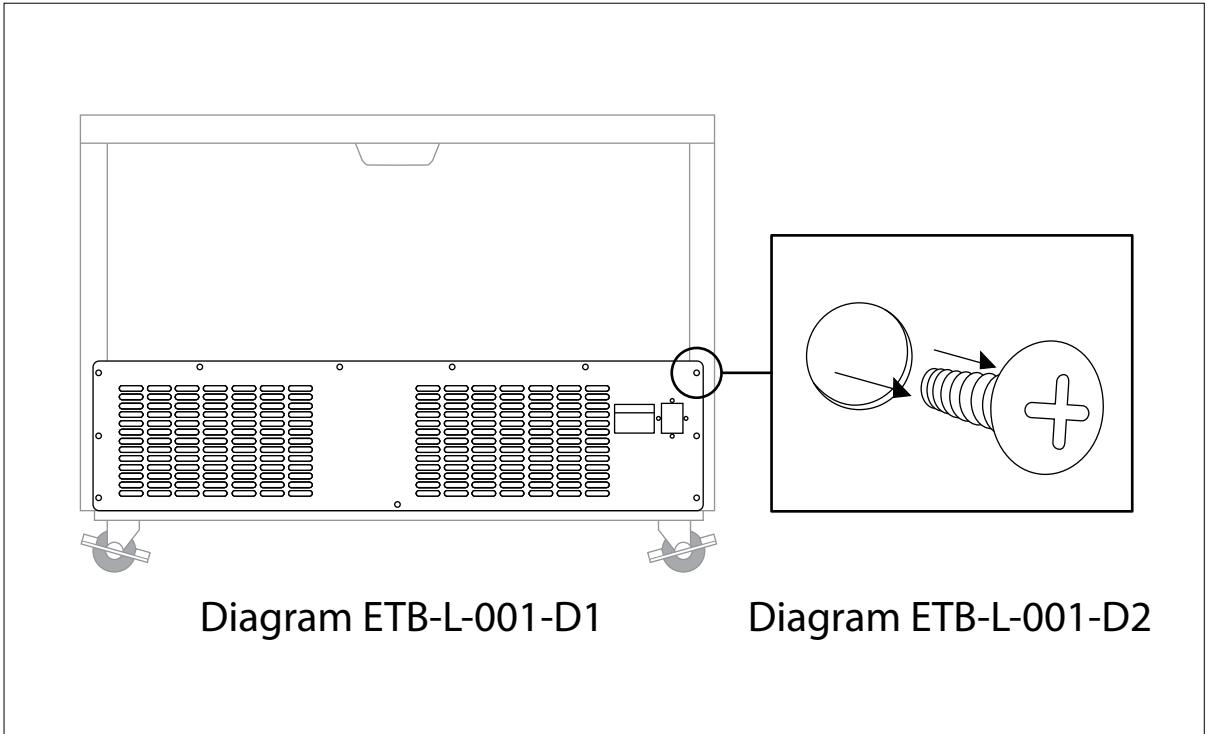

Diagram ETB-L-001-D1

Diagram ETB-L-001-D2

ETB Series

Applicable Model Prefix: ETB, EMGR5

Model Shown: ETBR2

IMPORTANT: Failure to clean the condenser coil will result in a void of warranty.
Follow these simple steps at least once a month to ensure the proper operation of your Everest product.

1. Always unplug the unit before performing maintenance.
2. Locate the condenser coil at the back of the unit. See diagrams ETB-L-001-D1 and ETB-L-001-D3.
3. Unscrew the back grill completely. See diagram ETB-L-001-D2.
4. Use any hard bristled brush in a vertical sweeping motion to remove lint, dust and debris from in between the aluminum fins of the condenser coil. Do not apply heavy pressure so as not to bend the fins*.
5. For grease-coated fins, use any commercial condenser coil cleaner*. Please follow the specific instructions on the bottle.
6. Repeat steps 4 to 5 until fins are clear of any blockage from lint, dust or grease.

* Do not use vacuum brush attachments and abrasive, acid-based cleaners or degreasers to avoid damage to the aluminum fins.

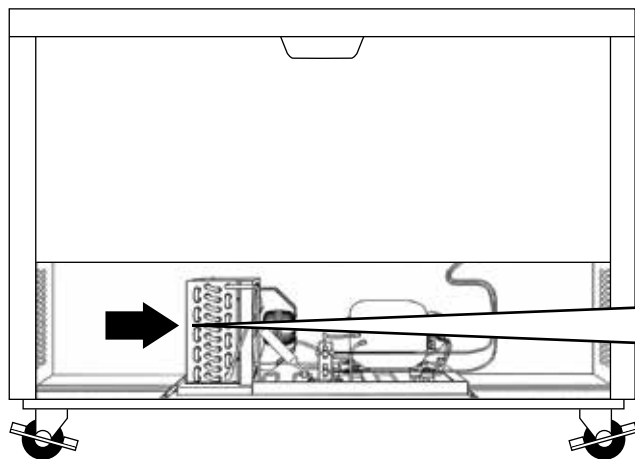

Diagram ETB-L-001-D3

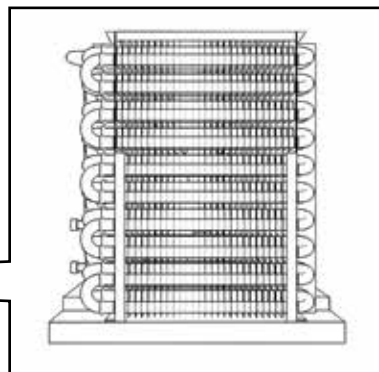



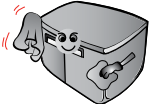
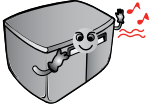
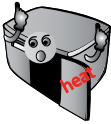



Diagram ETB-L-001-D4

Please check the following before requesting service

	Symptom	Possible Solutions
	Condensing unit fails to start	a. Ensure the electrical cord has been connected. b. Ensure the unit is turned on.
	Cabinet does not maintain proper temperature	a. Check the door gaskets for proper seal. b. Check to see if the temp. control setting is too high, then adjust as necessary. c. Avoid installing the unit next to heat generating equipment and direct sunlight. d. Avoid storing hot contents. e. Ensure the doors are fully closed.
	Refrigerated compartment is too cold	a. Adjust the temperature control to a warmer setting.
	Noisy operation	a. Check for loose parts. b. Check for tubing rattle. c. Check for a bent fan blade. d. Check for damaged fan motor bearings. e. Ensure the unit is stable. f. Ensure the cabinet is level.
	Condensation on the exterior surface	a. Condensation on the exterior surface of the unit is perfectly normal during periods of high humidity. b. Check door alignment and gaskets for proper seal.
	Sound of water dripping	a. This is the sound of the refrigerant circulating during the compressor rest period and it is normal.
	Exterior walls are warm	a. Heaters have been placed around the door openings to prevent condensation buildup. This is normal.
	Condensation on the interior	a. Condensation can occur during hot and humid weather with frequent or prolonged door opening. This is normal. b. The doors might not be closed properly. Check door alignment and gaskets for proper seal.

Shelves

The unit's shelves are adjustable so that the refrigerated compartment can be configured to suit your needs.

The shelf clip pilasters are spaced and labeled in 1" increments for your convenience.

Shelf Clip

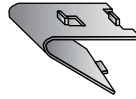

Pilaster

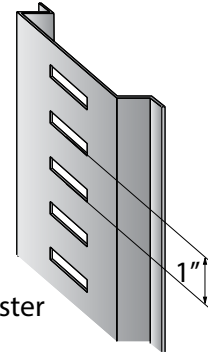

To install a shelf, hook the shelf clips into the pilasters by inserting the top part of the clips first and then the bottom. Each shelf requires 4 clips.

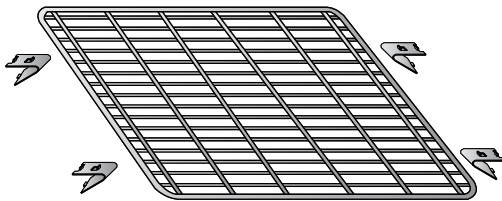

To remove a shelf, start by unloading the shelf. Second, remove the shelf itself. Finally, remove the shelf clips by tilting them up and allowing the bottom of the clip to come out first and then remove the top part of the clip from the pilaster.



Warning - Never attempt to adjust a shelf when loaded!



Back Mount Undercounter Refrigerators

Model	ETBR1	ETBSR2	ETBR2	ETBWR2	ETBR3
Capacity (Cu. Ft.)	5.6	7.5	10.3	15	18.3
Door(s)	1	2	2	2	3
Shelves	2	4	4	4	6
Compressor(Hp)	1/5	1/5	1/5	1/4+	1/3
Power (V-Hz-Ph)	115-60-1	115 -60-1	115-60-1	115-60-1	115-60-1
Temp. Range (°F)	32 ~ 42	32~ 42	32 ~ 42	32 ~ 42	32 ~ 42
Refrigerant	R-134A	R-134A	R-134A	R-134A	R-134A
Crated Weight (LBS)	181	213	256	311	353
Amps (A)	4.10	4.40	4.40	4.80	5.20
Ext. Dimensions (W x D x H* inches)	27 3/4 x 31 1/2 x 29 1/8	35 5/8 x 31 1/2 x 29 1/8	47 1/2 x 31 1/2 x 29 1/8	59 1/4 x 31 1/2 x 29 1/8	71 1/8 x 31 1/2 x 29 1/8

Back Mount Undercounter Freezers

Model	ETBF1	ETBSF2	ETBF2	ETBWF2	ETBF3
Capacity (Cu. Ft.)	5.6	7.5	10.3	15	18.3
Door(s)	1	2	2	2	3
Shelves	2	4	4	4	6
Compressor(Hp)	1/3+	1/3+	1/3+	1/2	1/2
Power (V-Hz-Ph)	115-60-1	115-60-1	115-60-1	115-60-1	115-60-1
Temp. Range (°F)	-4 ~ 32	-4 ~ 32	-4 ~ 32	-4 ~ 32	-4 ~ 32
Refrigerant	R-134A	R-134A	R-134A	R-404A	R-404A
Crated Weight (LBS)	195	231	270	320	363
Amps (A)	4.30	6.90	6.90	7.15	7.15
Ext. Dimensions (W x D x H* inches)	27 3/4 x 31 1/2 x 29 1/8	35 5/8 x 31 1/2 x 29 1/8	47 1/2 x 31 1/2 x 29 1/8	59 1/4 x 31 1/2 x 29 1/8	71 1/8 x 31 1/2 x 29 1/8

Drawered Undercounter Refrigerators

Model	ETBR1-D2	ETBSR2-D2	ETBR2-D4	ETBWR2-D4	ETBR3-D2
Capacity (Cu. Ft.)	5.6	7.5	10.3	15	18.3
Door(s)	2(DR)	2(DR)	4(DR)	4(DR)	1(D) 2(DR)
Shelves	-	-	-	-	2
Compressor(Hp)	1/5	1/5	1/5	1/4+	1/3
Power (V-Hz-Ph)	115-60-1	115-60-1	115-60-1	115-60-1	115-60-1
Temp. Range (°F)	32 ~ 42	32 ~ 42	32 ~ 42	32 ~ 42	32 ~ 42
Refrigerant	R-134A	R-134A	R-134A	R-134A	R-134A
Crated Weight (LBS)	200	234	291	347	373
Amps (A)	4.10	4.40	4.40	4.80	5.20
Ext. Dimensions (W x D x H* inches)	27 3/4 x 31 1/2 x 29 1/8	35 5/8 x 31 1/2 x 29 1/8	47 1/2 x 31 1/2 x 29 1/8	59 1/4 x 31 1/2 x 29 1/8	71 1/8 x 31 1/2 x 29 1/8

[NOTE]

* Exterior height does not include 5" for casters.

Drawer pans are not include for Drawered Undercounter Refrigerators.

Specifications subject to change without notice.



Side Mount Undercounters Refrigerators

Model	ETR1	ETR2	ETWR2	ETR3
Capacity (Cu. Ft.)	9	13	18	22
Door(s)	1	2	2	3
Shelves	2	4	4	6
Compressor(Hp)	1/4+	1/4+	1/4+	1/3
Power (V-Hz-Ph)	115-60-1	115 -60-1	115-60-1	115-60-1
Temp. Range (°F)	32 ~ 42	32~ 42	32 ~ 42	32 ~ 42
Refrigerant	R-134A	R-134A	R-134A	R-134A
Crated Weight (LBS)	129	268	320	353
Amps (A)	3.52	3.52	3.52	5.24
Ext. Dimensions (W x D x H* inches)	35 5/8 x 31 1/2 x 29 1/4	47 1/2 x 31 1/2 x 29 1/4	59 1/4 x 31 1/2 x 29 1/4	71 1/8 x 31 1/2 x 29 1/4

Side Mount Undercounters Freezers / Dual Temps

Model	ETF1 (Freezer)	ETF2 (Freezer)	ETWF2 (Freezer)	ETF3 (Freezer)	ETRF2 (Dual Temp)	ETRF3 (Dual Temp)
Capacity (Cu. Ft.)	9	13	18	22	9(R) 9(F)	14(R) 8(F)
Door(s)	1	2	2	3	2	3
Shelves	2	4	4	6	4	6
Compressor(Hp)	1/3	1/2	1/2	1/2	1/2	1/2
Power (V-Hz-Ph)	115-60-1	115-60-1	115-60-1	115-60-1	115-60-1	115-60-1
Temp. Range (°F)	-4 ~ 32	-4 ~ 32	-4 ~ 32	-4 ~ 32	-4 ~ 32	-4 ~ 32
Refrigerant	R-134A	R-404A	R-404A	R-404A	R-404A	R-404A
Crated Weight (LBS)	193	264	300	348	316	356
Amps (A)	4.24	7.50	7.50	7.50	8.12	8.12
Ext. Dimensions (W x D x H* inches)	35 5/8 x 31 1/2 x 29 1/4	47 1/2 x 31 1/2 x 29 1/4	59 1/4 x 31 1/2 x 29 1/4	71 1/8 x 31 1/2 x 29 1/4	59 1/4 x 31 1/2 x 29 1/4	71 1/8 x 31 1/2 x 29 1/4

Side Mount Glass Door Undercounter Refrigerators

Model	ETGSR2	ETGR2	ETGWR2
Capacity (Cu. Ft.)	13	18	23
Door(s)	2 (Sliding)	2 (Sliding)	2 (Sliding)
Shelves	4	4	4
Compressor(Hp)	1/4+	1/4+	1/3
Power (V-Hz-Ph)	115-60-1	115-60-1	115-60-1
Temp. Range (°F)	32 ~ 42	32 ~ 42	32 ~ 42
Refrigerant	R-134A	R-134A	R-134A
Crated Weight (LBS)	282	318	355
Amps (A)	2.94	2.94	5.24
Ext. Dimensions (W x D x H* inches)	47 1/2 x 31 1/2 x 29 1/4	59 1/4 x 31 1/2 x 29 1/4	71 1/8 x 31 1/2 x 29 1/4

[NOTE]

* Exterior height does not include 5" for casters.

Specifications subject to change without notice.

[Analog Temperature Knob Setting]

Applicable models: ETBR1, ETBSR2, ETBR2, ETBWR2, ETBR3

ETBF1, ETBSF2, ETBF2, ETBWF2, ETBF3

ETBR1-D2, ETBSR2-D2, ETBR2-D4, ETBWR2-D4, ETBR3-D2

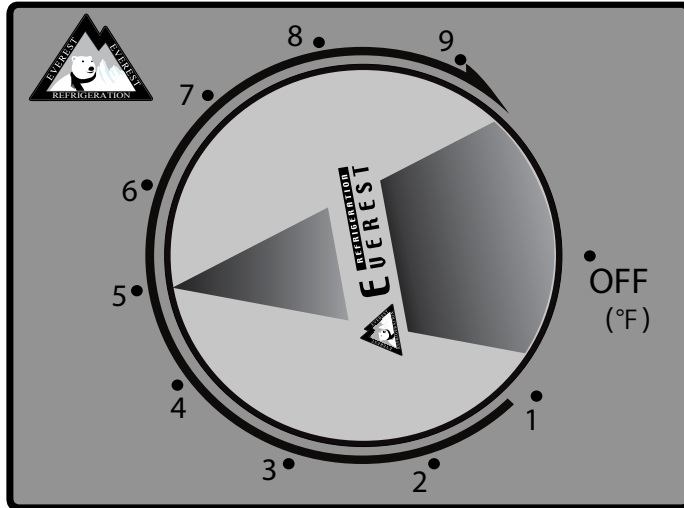

[Temperature Setting Range]

Setting Range	Comp.	REF(°F)	FZR(°F)
1 ~ 3	On	48	11
	Off	41	4
3 ~ 5	On	39	0.5
	Off	31	-6.5
6 ~ 9	On	30	-9.5
	Off	21	-17.5

• Factory Recommended Setting: "5"



[Digital Temperature Setting]

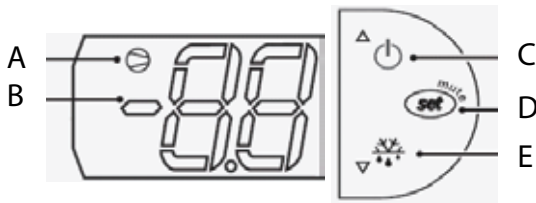

Applicable models: ETR1, ETR2, ETWR2, ETR3, ETF1, ETF2, ETWF2, ETF3, ETRF2, ETRF3
ETGSR2, ETGR2, ETGWR2



* LED Display

- A Operation of compressor
- B Current cabinet temperature

* Control Buttons

-  C Power button
-  D Temperature setting button
-  E Defrost button

* How to set desired temperature

- Step 1 Press and hold " **D** " button until the LED displays " **set** " symbol and a number consecutively. The number is the previous setting temperature (Recommended setting Temp- Refrigerator : 35°F, Freezer : -4°F) When the number is flashing, release the button.
Caution: If " **PS** " symbol appears on the LED, it means that you pressed and held " **D** " button too long. Release it, and then press " **D** " button twice to restart the temperature setting.
- Step 2 While flashing the number, set your desired temperature by pressing " **C** " (high) or " **E** " (low) button. The number increases or decreases by a decimal point.
- Note: Your new setting temperature should be in the range of between 32°F and 42°F for refrigerator and -4°F~34°F for Freezer
- Step 3 Press " **D** " button to get out of the setting mode. The LED will show the current cabinet temperature.

Drawered Undercounter Refrigerator

Drawer pans are not included in this product as standard, Customers need to purchase them separately.
 *Custom pan dividers required to fit standard full sized pans. Contact manufacturer for details.

ETBR1-D2

[Standard: (1) pan divider per drawer included]

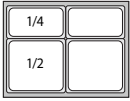

Top Drawer
Pan Depth 4"



Top Drawer
Pan Depth 6"

ETBSR2-D2

[Standard: (2) pan dividers per drawer included]

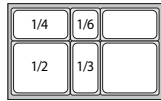

Top Drawer
Pan Depth 4"



Top Drawer
Pan Depth 6"

ETBR2-D4

[Standard: (1) pan divider per drawer included]



Top Drawer
Pan Depth 4"

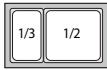

Top Drawer
Pan Depth 6"

ETBWR2-D4

[Standard: (2) pan dividers per drawer included]



Top Drawer
Pan Depth 4"



Top Drawer
Pan Depth 6"

ETBR3-D2

[Standard: (4) pan dividers per drawer included]



Top Drawer
Pan Depth 4"



Top Drawer
Pan Depth 6"



Optional
4" high backsplash

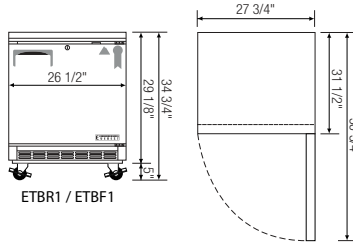
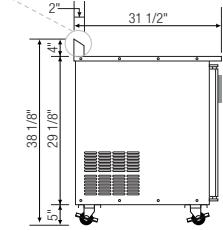

ETBR1 / ETBF1

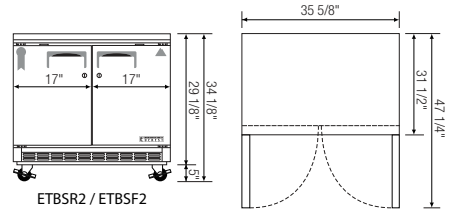

ETBSR2 / ETBSF2

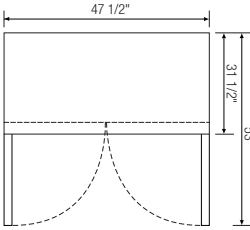

ETBR2 / ETBF2

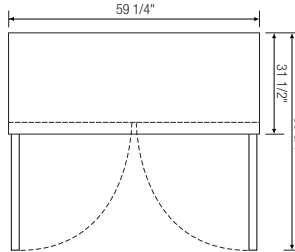

ETBWR2 / ETBWF2

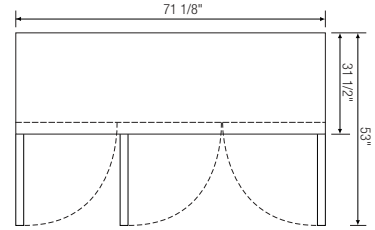

ETBR3 / ETBF3

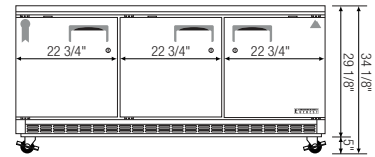
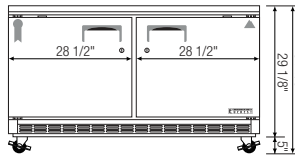
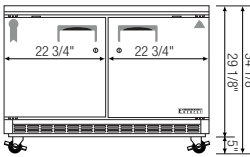

Optional
4" high backsplash

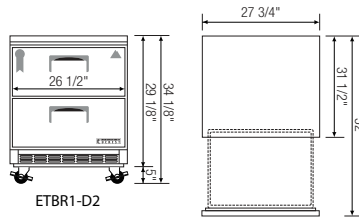
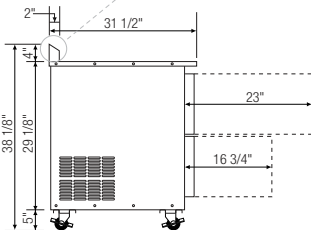

ETBR1-D2

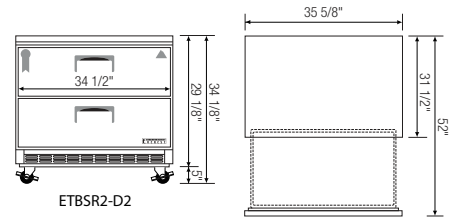

ETBSR2-D2

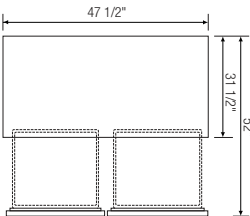

ETBR2-D4

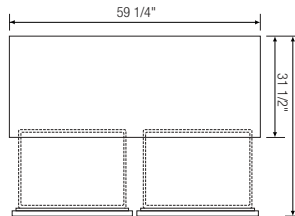

ETBWR2-D4

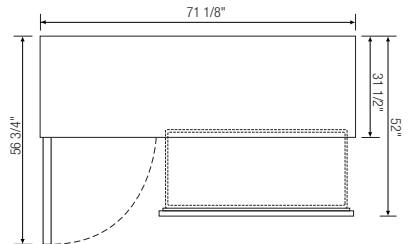

ETBR3-D2

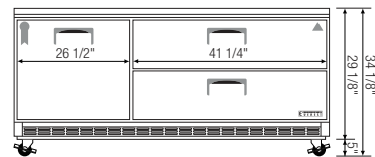
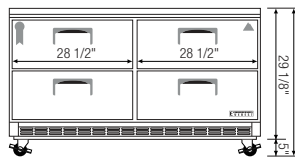
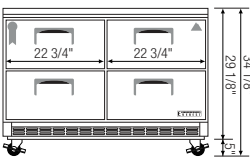



Optional
4" high backsplash

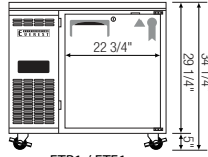
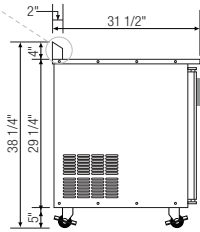

ETR1 / ETF1

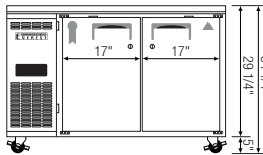
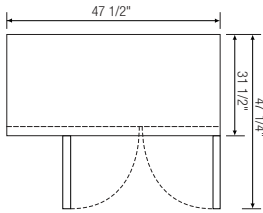
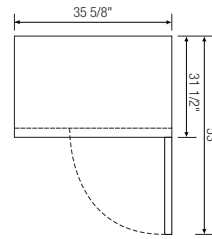

ETR2 / ETF2

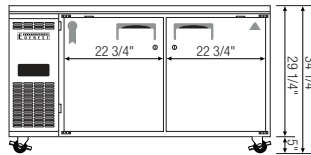
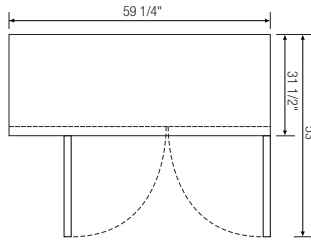

ETR2 / ETF2

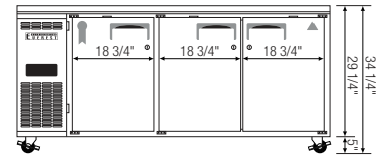
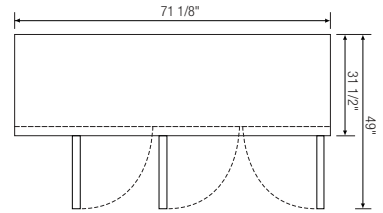

ETR3 / ETF3

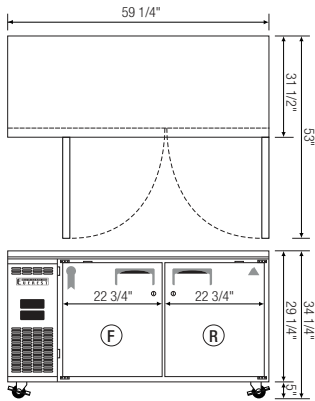

ETRF2

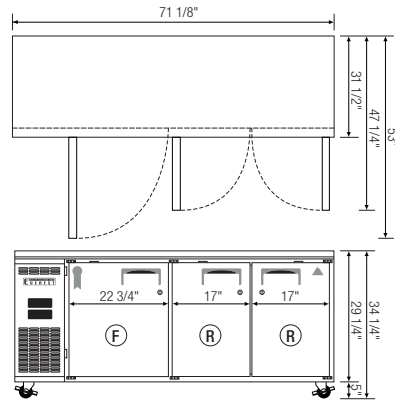

ETRF3

Optional
4" high backsplash

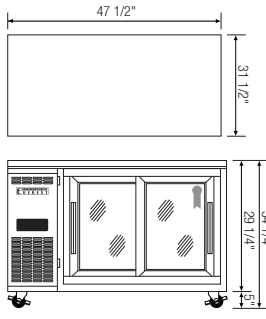
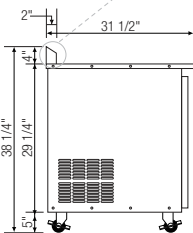

ETGSR2

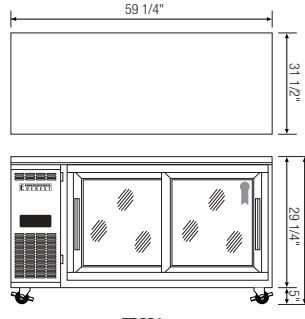

ETGR2

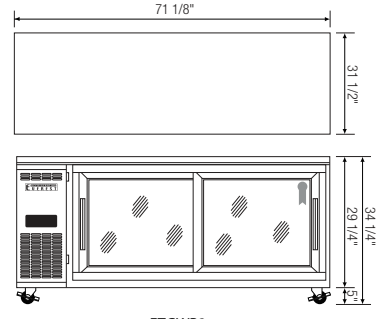

ETGWR2



The warranty card below must be submitted to Everest within thirty (30) days of purchase.

WARRANTY REGISTRATION CARD

Business Name : _____ Telephone : () _____

Address : _____

City : _____ State : _____ Zip : _____

Place of Purchase : _____ Date Purchased : _____ Date Installed : _____

Model No : _____ Cabinet Serial No : _____

3* YEAR PARTS and LABOR WARRANTY

(Applicable to units purchased after July 1, 2014.)

5 YEAR COMPRESSOR WARRANTY

Name of Business Owner : _____ Date : _____

Signature of Business Owner : _____

** Terms may vary. Contact Everest for further details.*

EVEREST LIMITED WARRANTY

EVEREST warrants to the original purchaser of every new EVEREST unit, the cabinet and all parts thereof, to be free from defects in material or workmanship, under normal and proper use and maintenance service as specified by EVEREST and upon proper installation and start-up in accordance with the instruction packet supplied with each unit. Our obligation under this warranty is limited to a period of three (3)* years from the date of original installation or thirty six (36)* months after shipment date from EVEREST, whichever occurs first (applicable to units purchased after July 1, 2014). Any part covered under this warranty that is determined by EVEREST to have been defective within three (3)* years of original installation or thirty six (36)* months after shipment date from the manufacturer, whichever occurs first, is limited to the repair or replacement, including labor charges, of defective parts or assemblies. The labor warranty shall include standard straight time labor charges only and reasonable travel time, as determined by EVEREST.

WARRANTY CLAIMS

All warranty claims for labor or parts must be made directly through EVEREST. All claims shall include: unit model number, cabinet serial number, proof of new product purchase, installation date, and all pertinent information related to the reported defect. For compressor warranty claims, the compressor tag shall be returned to EVEREST along with the above listed information.

WARRANTY EXCLUSIONS

EVEREST's sole obligation under this warranty is limited to either the repair or replacement of parts, subject to the additional limitations below. This warranty neither assumes nor authorizes any person to assume obligations other than those expressly covered by this warranty.

- A. **NON WARRANTY PARTS.** EVEREST excludes specific parts exposed to normal wear and tear. These parts include, but are not limited to, lamps, gaskets, casters, shelves and shelf clips, pans, bin and pan dividers and airflow guards.
- B. **INDIRECT OR CONSEQUENTIAL DAMAGE.** EVEREST does not warrant economic loss, profit loss, or special, indirect or consequential damages including without limitation, losses or damages arising from food or product spoilage claims caused by refrigeration failure.
- C. **IMPROPER USAGE.** EVEREST is not responsible for parts or labor coverage for component failure and or other damages resulting from improper usage, installation or failure to clean and/or maintain the unit as set forth in the user's manual provided with this unit. All EVEREST units are designed for commercial use, not for residential use. Warranty is invalid if the unit is installed in a residence.
- D. **WARRANTY IS NOT TRANSFERRABLE.** Warranty is limited to only the original purchaser/user to which the unit was delivered. Warranty does not transfer with change of ownership.
- E. **ALTERATION, NEGLIGENCE, MISUSE, ABUSE, ACCIDENT, DAMAGE DURING TRANSIT OR INSTALLATION, FIRE, FLOOD, ACTS OF GOD.** EVEREST is not responsible for malfunctions due to alteration, neglect, misuse, abuse, accident, damage during transit or installation, fire, flood, storm, and/or other acts of God. EVEREST is not responsible for any improper electrical connections resulting from electrical power failure, the use of extension cords, and low voltage or voltage drops to the unit.
- F. **UNAUTHORIZED MODIFICATION.** EVEREST is not responsible for the repair or replacement of failed or damaged components resulting from unauthorized modifications to units or the use of non- standard parts without prior written approval from EVEREST.
- G. **OUTSIDE THE U.S.** This warranty does not apply to any parts and/or labor warranty claims made on units sold or used outside of the United States.

FIVE (5) YEAR COMPRESSOR WARRANTY

In addition to the warranty set forth above, EVEREST warrants the hermetically sealed compressor for five (5) years, not to exceed sixty (60) months from the unit's date of shipment from EVEREST. To qualify for a compressor warranty claim, the replacement compressor must have been purchased directly from EVEREST. Claimants must submit the compressor warranty form, original compressor and electrical components to EVEREST. Additionally, examination by EVEREST must confirm the compressor and electrical components to be defective as claimed. This compressor warranty does not apply to shipping and labor costs or other parts whether electrical or mechanical.

These warranties are exclusive and in lieu of all other warranties, expressed or implied, and all other obligations or liabilities on our part, and we neither assume nor authorize any other person to assume for us any other obligation or liability in connection with the sale of said refrigeration units or any part thereof.

** Terms may vary. Contact Everest for further details.*







REFRIGERATION
EVEREST



A Step Above the Standard

201 W. Artesia Blvd., Compton CA 90220

Tel : 310-323-6586, 800-444-6285

Fax : 310-323-7524, 310-761-1127

Visit our website at www.EVERESTref.com