

CROWN MODEL No. I565-CRD CORRESPONDING TO
 MODEL CRD 50-BT AND CRD 50-EA-BT
 CROWN MODEL No. I575-CRD CORRESPONDING TO
 MODEL CRD 55-BT AND CRD 55-EA-BT

TRUSS/GYPSUM INSTALLATION INSTRUCTIONS

MODEL CRD 50-BT AND CRD 50-EA-BT (90° RECTANGLE CRD/REGISTER BOX ASM.)
 MODEL CRD 55-BT AND CRD 55-EA-BT (STRAIGHT RECTANGLE CRD/REGISTER BOX ASM.)
 MODEL CRD 55-BT-45° AND MODEL CRD 55-EA-BT-45°

OPTIONAL
 90° FORMED
 ANGLE ENDS
 FOR SIDE
 FASTENING
 IN TRUSSES

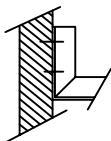

OPTIONAL
 FLUSH MOUNT
 INSTALLATION
 DRIVE "S" LOCKS
 ON BOX FLANGES
 IN PLACE OF
 HANGER ANGLES

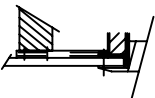

OPTIONAL
 DROP CEILING
 INSTALLATION
 WITH .06 DIA.
 WIRE FASTENERS
 ON PROVIDED
 HANGER BRACKETS

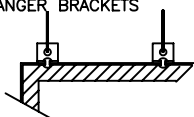

1 HOUR RATED ASSEMBLIES FOR USE IN
 FLOOR/CEILING, ROOF/CEILING: TRUSS/GYPSUM CONSTRUCTION
 UL DESIGNS: L563, L585, L574, P544, P547, P545

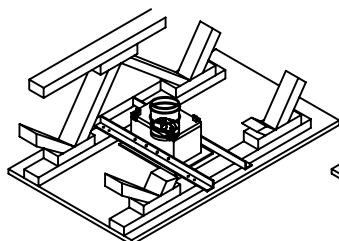
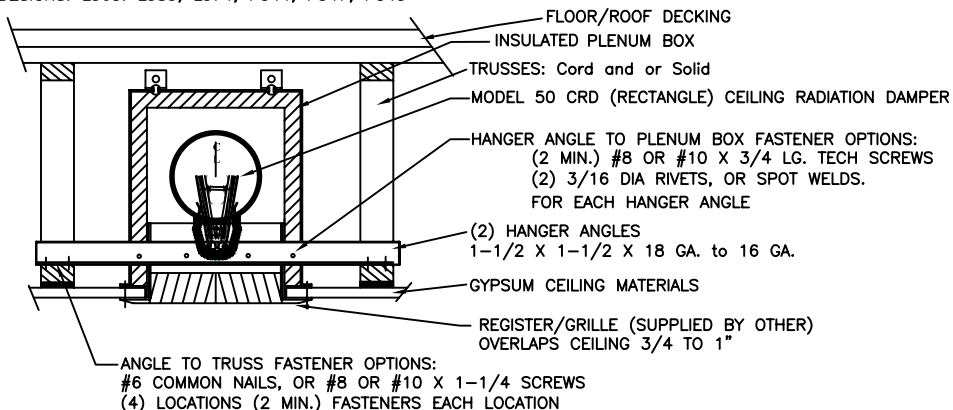

MODEL 55-EA-BT STRAIGHT DUCTING

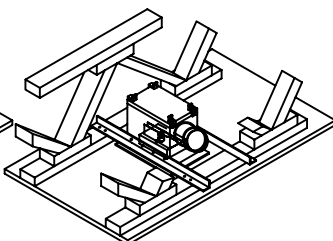

MODEL 50-EA-BT DUCTED 90° THRU TRUSSES

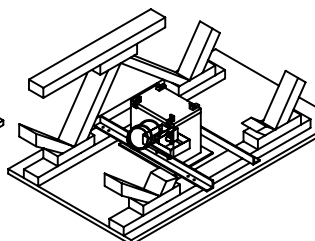

MODEL 50-EA-BT DUCTED 90° PARALLEL TO TRUSSES

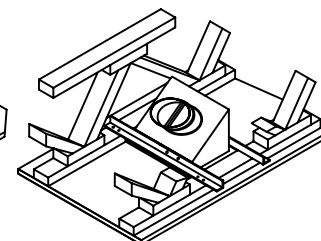

MODEL CRD55-BT-45°

Notes:

- Before installing the damper, CRD Model 50-BT (rectangle), and CRD Model 50-EA-BT (rectangle) open the blades and hook the fusible link over the link catch on the opposite blade. Bend down the link catch to secure the link in position. For CRD Model 50-EA-BT flex the spring wire and secure the link.
- Measure the actual truss centers and add approx. 6" to determine straight angle lengths. (2 required per box) When using the optional formed angle allow for adequate flanges at each mounting point and cut and bend the angles on both ends to 90 degrees. or the appropriate angle required.
- Establish the location of the gypsum flange and fasten the (2) hanger angles to the plenum box with (2) minimum #8 x 3/4 sheet metal screws or 3/16 diameter rivets for each hanger angle. spot welding or bolts. Four connections on each angle as a minimum. Note: fastener positions must not interfere with the damper blade operation.
- Mounting angles are fastened to joists or other structural members with a minimum of two fasteners for each mounting point using #6 common nails or #8 x 1-1/4" long screws.
- The clearance between each side of the ceiling damper and the duct drop shall be 1/8 inch maximum.
- Steel or Aluminum grille or diffuser to be attached to the duct drop or ceiling damper using No. 8 by 1/2 inch long sheet metal screws at 6 inches o.c. and a minimum of (3) places.

IMPORTANT:
 FASTENERS MUST NOT INTERFERE WITH THE DAMPER BLADES OPERATION.

