

Service Facts

Variable Speed AccuLink™ Heat Pumps and Air Conditioners

4A6V8024A1000B
4A6V8036A1000B
4A6V8037A1000B
4A6V8048A1000B
4A6V8049A1000B
4A6V8060A1000B

4A7V8024A1000B
4A7V8036A1000B
4A7V8037A1000B
4A7V8048A1000B
4A7V8060A1000B

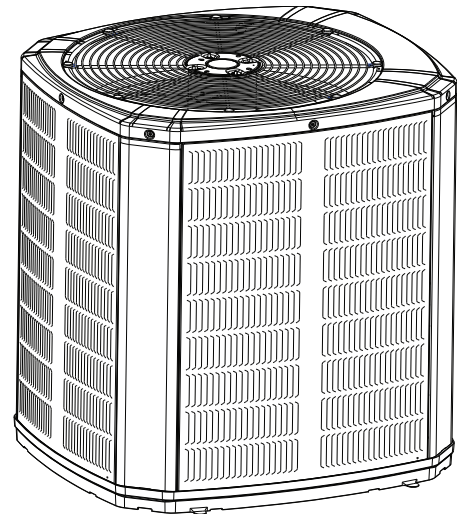

Note: "Graphics in this document are for representation only. Actual model may differ in appearance."



Scan to see help
videos on this
product

⚠ SAFETY WARNING

Only qualified personnel should install and service the equipment. The installation, starting up, and servicing of heating, ventilating, and air-conditioning equipment can be hazardous and requires specific knowledge and training. Improperly installed, adjusted or altered equipment by an unqualified person could result in death or serious injury. When working on the equipment, observe all precautions in the literature and on the tags, stickers, and labels that are attached to the equipment.

SAFETY SECTION – OUTDOOR

Important — This document contains a wiring diagram and service information. This is customer property and is to remain with this unit. Please return to service information pack upon completion of work.

⚠ WARNING

HAZARDOUS VOLTAGE!

Failure to follow this Warning could result in property damage, severe personal injury, or death. Disconnect all electric power, including remote disconnects before servicing. Follow proper lockout/tagout procedures to ensure the power cannot be inadvertently energized.

⚠ WARNING

REFRIGERANT OIL!

Any attempt to repair a central air conditioning product may result in property damage, severe personal injury, or death. These units use R-410A refrigerant which operates at 50 to 70% higher pressures than R-22. Use only R-410A approved service equipment. Refrigerant cylinders are painted a "Rose" color to indicate the type of refrigerant and may contain a "dip" tube to allow for charging of liquid refrigerant into the system. All R-410A systems with variable speed compressors use a PVE oil that readily absorbs moisture from the atmosphere. To limit this "hygroscopic" action, the system should remain sealed whenever possible. If a system has been open to the atmosphere for more than 4 hours, the compressor oil must be replaced. Never break a vacuum with air and always change the driers when opening the system for component replacement.

⚠ CAUTION

HOT SURFACE!

May cause minor to severe burning. Failure to follow this Caution could result in property damage or personal injury. Do not touch top of compressor.

⚠ CAUTION

CONTAINS REFRIGERANT!

Failure to follow proper procedures can result in personal illness or injury or severe equipment damage. System contains oil and refrigerant under high pressure. Recover refrigerant to relieve pressure before opening system.

⚠ CAUTION

GROUNDING REQUIRED!

Failure to inspect or use proper service tools may result in equipment damage or personal injury. Reconnect all grounding devices. All parts of this product that are capable of conducting electrical current are grounded. If grounding wires, screws, straps, clips, nuts, or washers used to complete a path to ground are removed for service, they must be returned to their original position and properly fastened.

⚠ WARNING

SERVICE VALVES!

Failure to follow this warning will result in abrupt release of system charge and may result in personal injury and/or property damage. Extreme caution should be exercised when opening the Liquid Line Service Valve. Turn valve stem counterclockwise only until the stem contacts the rolled edge. No torque is required.

⚠ WARNING

BRAZING REQUIRED!

Failure to inspect lines or use proper service tools may result in equipment damage or personal injury. if using existing refrigerant lines make certain that all joints are brazed, not soldered.

⚠ WARNING

HIGH LEAKAGE CURRENT!

Failure to follow this Warning could result in property damage, severe personal injury, or death. Earth connection essential before connecting electrical supply.

⚠ WARNING



**400 VOLTS
ELECTRICAL HAZARD**

Failure to follow this warning could result in personal injury or death.

WAIT TWO (2) MINUTES after disconnecting power prior to touching electrical components as they may hold a dangerous charge of 400VDC, then verify DC Voltage is less than 42 VDC at inverter test points labeled +VDC and -VDC before servicing board.



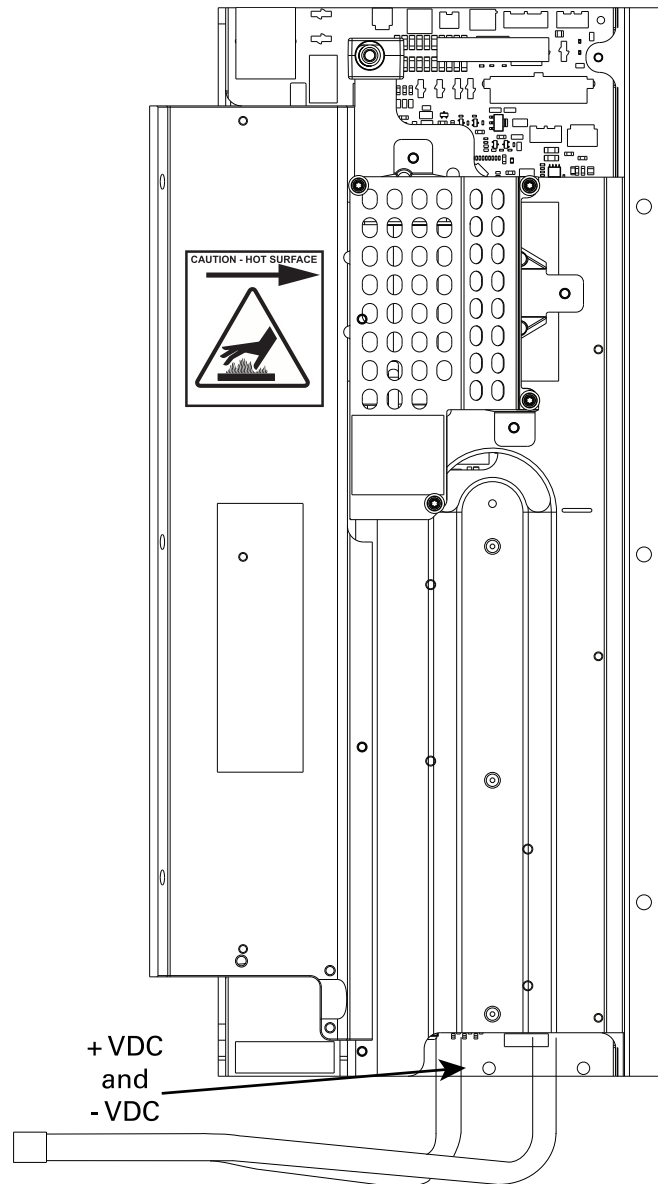

Approved Combinations for Variable Speed Units

- AZONE 850 Comfort Control, or AZONE 950 with Software Version 3.0 or Higher
- TAM8C or later models
- Platinum SV Furnace
- Platinum ZV Furnace
- Approved System Accessories

Note: See AHRI directory for approved indoor and outdoor model combinations. Only Trane coils and air handlers are approved for use with variable speed outdoor units.



Scan to see an overview video about the IVSC Board

Table 1. Operating Range

Cooling	55° F to 120° F
Heating	-10° F to 66° F

Product Specifications

HEAT PUMP MODELS

OUTDOOR UNIT ^{(a) (b)}	4A6V8024A1000B	4A6V8036A1000B	4A6V8037A1000B
POWER CONNS. — V/PH/HZ ^(c)	208/230/1/60	208/230/1/60	208/230/1/60
MIN. BRCH. CIR. AMPACITY	17.0	25.0	26.0
BR. CIR. PROT. RTG. — MAX. (AMPS)	25	35	40
COMPRESSOR	SCROLL	SCROLL	SCROLL
NO. USED — NO. SPEEDS	1-VARIABLE	1-VARIABLE	1-VARIABLE
R.L. AMPS ^(d) — L.R. AMPS	11.5 — 10.2	18.1 — 10.2	18.4 — 10.2
FACTORY INSTALLED			
START COMPONENTS ^(e)	NA	NA	NA
INSULATION/SOUND BLANKET	YES	YES	YES
COMPRESSOR HEAT	YES	YES	YES
OUTDOOR FAN			
DIA. (IN.) — NO. USED	23 — 1	23 — 1	27.5 — 1
TYPE DRIVE — NO. SPEEDS	DIRECT — VARIABLE	DIRECT — VARIABLE	DIRECT — VARIABLE
CFM @ 0.0 IN. W.G. ^(f)	2680	2850	3670
NO. MOTORS — HP	1 — 1/3	1 — 1/3	1 — 1/3
MOTOR SPEED R.P.M.	200 — 1200	200 — 1200	200 — 1200
VOLTS/PH/HZ	208/230/1/60	208/230/1/60	208/230/1/60
F.L. AMPS	2.8	2.8	2.8
OUTDOOR COIL — TYPE	SPINE FIN [™]	SPINE FIN [™]	SPINE FIN [™]
ROWS — F.P.I.	1 — 24	1 — 24	1 — 24
FACE AREA (SQ. FT.)	19.77	23.75	27.87
TUBE SIZE (IN.)	3/8	3/8	3/8
REFRIGERANT	R410-A	R410-A	R410-A
LBS. — R-410A (O.D. UNIT) ^(g)	7 lb — 6 oz	8 lb — 3 oz	9 lb — 8 oz
FACTORY SUPPLIED	YES	YES	YES
LINE SIZE — IN. O.D. GAS ^(h)	5/8	3/4	3/4
LINE SIZE — IN. O.D. LIQ. ^(h)	3/8	3/8	3/8
CHARGING SPECIFICATIONS			
SUBCOOLING	10°	10°	9°
DIMENSIONS	H X W X D	H X W X D	H X W X D
CRATED (IN.)	46 X 30.1 X 33	46 X 30.1 X 33	46.4 x 35.1 x 38.7
WEIGHT			
SHIPPING (LBS.)	225	238	263
NET (LBS.)	204	217	238

^(a) Certified in accordance with the Air-Source Unitary Air-conditioner Equipment certification program, which is based on AHRI standard 210/240.

^(b) Rated in accordance with AHRI standard 270.

^(c) Calculated in accordance with Natl. Elec. Codes. Use only HACR circuit breakers or fuses.

^(d) This value shown for compressor RLA on the unit nameplate and on this specification sheet is used to compute minimum branch circuit ampacity and max. fuse size. The value shown is the branch circuit selection current.

^(e) No means no start components. Yes means quick start kit components. PTC means positive temperature coefficient starter.

^(f) Standard Air — Dry Coil — Outdoor

^(g) This value approximate. For more precise value see unit nameplate.

^(h) Max. linear length 150 ft.; Max. lift — Suction 50 ft.; Max. lift — Liquid 50 ft..

HEAT PUMP MODELS CONT.

OUTDOOR UNIT ^{(a) (b)}	4A6V8048A1000B	4A6V8049A1000B	4A6V8060A1000B
POWER CONNS. — V/PH/HZ ^(c)	208/230/1/60	208/230/1/60	208/230/1/60
MIN. BRCH. CIR. AMPACITY	28.0	29.0	37.0
BR. CIR. PROT. RTG. — MAX. (AMPS)	40	45	50
COMPRESSOR	SCROLL	SCROLL	SCROLL
NO. USED — NO. SPEEDS	1-VARIABLE	1-VARIABLE	1-VARIABLE
R.L. AMPS ^(d) — L.R. AMPS	20.3 — 12.0	21.1 — 12.0	27.5 — 12.0
FACTORY INSTALLED			
START COMPONENTS ^(e)	NA	NA	NA
INSULATION/SOUND BLANKET	YES	YES	YES
COMPRESSOR HEAT	YES	YES	YES
OUTDOOR FAN			
DIA. (IN.) — NO. USED	27.5 — 1	27.5 — 1	27.5 — 1
TYPE DRIVE — NO. SPEEDS	DIRECT — VARIABLE	DIRECT — VARIABLE	DIRECT — VARIABLE
CFM @ 0.0 IN. W.G. ^(f)	4467	4517	4757
NO. MOTORS — HP	1 — 1/3	1 — 1/3	1 — 1/3
MOTOR SPEED R.P.M.	200 — 1200	200 — 1200	200 — 1200
VOLTS/PH/HZ	208/230/1/60	208/230/1/60	208/230/1/60
F.L. AMPS	2.8	2.8	2.8
OUTDOOR COIL — TYPE	SPINE FIN™	SPINE FIN™	SPINE FIN™
ROWS — F.P.I.	1 — 24	1 — 24	1 — 24
FACE AREA (SQ. FT.)	27.87	27.87	30.80
TUBE SIZE (IN.)	3/8	3/8	3/8
REFRIGERANT	R410-A	R410-A	R410-A
LBS. — R-410A (O.D. UNIT) ^(g)	9 lb — 13 oz	10 lb — 12 oz	11 lb — 14 oz
FACTORY SUPPLIED	YES	YES	YES
LINE SIZE — IN. O.D. GAS	7/8 ^(h)	7/8 ^(h)	1 — 1/8 ⁽ⁱ⁾
LINE SIZE — IN. O.D. LIQ. ^(h)	3/8	3/8	3/8
CHARGING SPECIFICATIONS			
SUBCOOLING	10°	10°	10°
DIMENSIONS	H X W X D	H X W X D	H X W X D
CRATED (IN.)	46.4 x 35.1 x 38.7	46.4 x 35.1 x 38.7	51 X 35.1 X 38.7
WEIGHT			
SHIPPING (LBS.)	268	275	285
NET (LBS.)	243	250	259

^(a) Certified in accordance with the Air-Source Unitary Air-conditioner Equipment certification program, which is based on AHRI standard 210/240.

^(b) Rated in accordance with AHRI standard 270.

^(c) Calculated in accordance with Natl. Elec. Codes. Use only HACR circuit breakers or fuses.

^(d) This value shown for compressor RLA on the unit nameplate and on this specification sheet is used to compute minimum branch circuit ampacity and max. fuse size. The value shown is the branch circuit selection current.

^(e) No means no start components. Yes means quick start kit components. PTC means positive temperature coefficient starter.

^(f) Standard Air — Dry Coil — Outdoor

^(g) This value approximate. For more precise value see unit nameplate.

^(h) Max. linear length 150 ft.; Max. lift — Suction 50 ft.; Max. lift — Liquid 50 ft.

⁽ⁱ⁾ Max length of refrigerant lines from outdoor to indoor unit MUST NOT exceed 80 feet. The max vertical change MUST NOT exceed 10 feet. See footnote (h) if 7/8" suction line is used.

Product Specifications

Air Conditioner Models

OUTDOOR UNIT ^{(a)(b)}	4A7V8024A1000B	4A7V8036A1000B	4A7V8037A1000B
POWER CONNS. — V/PH/HZ ^(c)	208/230/1/60	208/230/1/60	208/230/1/60
MIN. BRCH. CIR. AMPACITY	17.0	18.0	18.0
BR. CIR. PROT. RTG. — MAX. (AMPS)	25	25	25
COMPRESSOR	SCROLL	SCROLL	SCROLL
NO. USED — NO. SPEEDS	1-VARIABLE	1-VARIABLE	1-VARIABLE
R.L. AMPS ^(d) — L.R. AMPS	11.5 — 10.2	12.4 — 10.2	12.4 — 10.2
FACTORY INSTALLED			
START COMPONENTS ^(e)	NA	NA	NA
INSULATION/SOUND BLANKET	YES	YES	YES
COMPRESSOR HEAT	YES	YES	YES
OUTDOOR FAN			
DIA. (IN.) — NO. USED	23 — 1	23 — 1	27.5 — 1
TYPE DRIVE — NO. SPEEDS	DIRECT — VARIABLE	DIRECT — VARIABLE	DIRECT — VARIABLE
CFM @ 0.0 IN. W.G. ^(f)	2680	2850	3670
NO. MOTORS — HP	1 — 1/3	1 — 1/3	1 — 1/3
MOTOR SPEED R.P.M.	200 — 1200	200 — 1200	200 — 1200
VOLTS/PH/HZ	208/230/1/60	208/230/1/60	208/230/1/60
F.L. AMPS	2.8	2.8	2.8
OUTDOOR COIL — TYPE	SPINE FIN™	SPINE FIN™	SPINE FIN™
ROWS — F.P.I.	1 — 24	1 — 24	1 — 24
FACE AREA (SQ. FT.)	19.77	23.75	27.87
TUBE SIZE (IN.)	3/8	3/8	3/8
REFRIGERANT	R410-A	R410-A	R410-A
LBS. — R-410A (O.D. UNIT) ^(g)	7 lb — 6 oz	7 lb — 14 oz	9 lb — 6 oz
FACTORY SUPPLIED	YES	YES	YES
LINE SIZE — IN. O.D. GAS	5/8 ^(h)	3/4 ^(h)	3/4 ^(h)
LINE SIZE — IN. O.D. LIQ. ^(h)	3/8	3/8	3/8
CHARGING SPECIFICATIONS			
SUBCOOLING	10°	10°	10°
DIMENSIONS	H X W X D	H X W X D	H X W X D
CRATED (IN.)	46 X 30.1 X 33	46 X 30.1 X 33	46.4 X 35.1 X 38.7
WEIGHT			
SHIPPING (LBS.)	217	228	248
NET (LBS.)	196	207	225

^(a) Certified in accordance with the Air-Source Unitary Air-conditioner Equipment certification program, which is based on AHRI standard 210/240.

^(b) Rated in accordance with AHRI standard 270.

^(c) Calculated in accordance with Natl. Elec. Codes. Use only HACR circuit breakers or fuses.

^(d) This value shown for compressor RLA on the unit nameplate and on this specification sheet is used to compute minimum branch circuit ampacity and max. fuse size. The value shown is the branch circuit selection current.

^(e) No means no start components. Yes means quick start kit components. PTC means positive temperature coefficient starter.

^(f) Standard Air — Dry Coil — Outdoor

^(g) This value approximate. For more precise value see unit nameplate.

^(h) Max. linear length 150 ft.; Max. lift — Suction 50 ft.; Max. lift — Liquid 50 ft.

Air Conditioner Models

OUTDOOR UNIT ^{(a) (b)}	4A7V8048A1000B	4A7V8060A1000B
POWER CONNS. — V/PH/HZ ^(c)	208/230/1/60	208/230/1/60
MIN. BRCH. CIR. AMPACITY	23.0	27.0
BR. CIR. PROT. RTG. — MAX. (AMPS)	35	40
COMPRESSOR	SCROLL	SCROLL
NO. USED — NO. SPEEDS	1-VARIABLE	1-VARIABLE
R.L. AMPS ^(d) — L.R. AMPS	16.0 — 12.0	19.3 — 12.0
FACTORY INSTALLED		
START COMPONENTS ^(e)	NA	NA
INSULATION/SOUND BLANKET	YES	YES
COMPRESSOR HEAT	YES	YES
OUTDOOR FAN		
DIA. (IN.) — NO. USED	27.5 — 1	27.5 — 1
TYPE DRIVE — NO. SPEEDS	DIRECT — VARIABLE	DIRECT — VARIABLE
CFM @ 0.0 IN. W.G. ^(f)	4560	4787
NO. MOTORS — HP	1 — 1/3	1 — 1/3
MOTOR SPEED R.P.M.	200 — 1200	200 — 1200
VOLTS/PH/HZ	208/230/1/60	208/230/1/60
F.L. AMPS	2.8	2.8
OUTDOOR COIL — TYPE	SPINE FIN™	SPINE FIN™
ROWS — F.P.I.	1 — 24	1 — 24
FACE AREA (SQ. FT.)	27.87	30.80
TUBE SIZE (IN.)	3/8	3/8
REFRIGERANT	R410-A	R410-A
LBS. — R-410A (O.D. UNIT) ^(g)	11 lb — 1 oz	11 lb — 14 oz
FACTORY SUPPLIED	YES	YES
LINE SIZE — IN. O.D. GAS	7/8 ^(h)	1 — 1/8 ^(h)
LINE SIZE — IN. O.D. LIQ. ^(h)	3/8	3/8
CHARGING SPECIFICATIONS		
SUBCOOLING	10°	10°
DIMENSIONS	H X W X D	H X W X D
CRATED (IN.)	46.4 X 35.1 X 38.7	51 X 35.1 X 38.7
WEIGHT		
SHIPPING (LBS.)	270	284
NET (LBS.)	245	258

^(a) Certified in accordance with the Air-Source Unitary Air-conditioner Equipment certification program, which is based on AHRI standard 210/240.

^(b) Rated in accordance with AHRI standard 270.

^(c) Calculated in accordance with Natl. Elec. Codes. Use only HACR circuit breakers or fuses.

^(d) This value shown for compressor RLA on the unit nameplate and on this specification sheet is used to compute minimum branch circuit ampacity and max. fuse size. The value shown is the branch circuit selection current.

^(e) No means no start components. Yes means quick start kit components. PTC means positive temperature coefficient starter.

^(f) Standard Air — Dry Coil — Outdoor

^(g) This value approximate. For more precise value see unit nameplate.

^(h) Max length of refrigerant lines from outdoor to indoor unit MUST NOT exceed 80 feet. The max vertical change MUST NOT exceed 25 feet. See footnote (h) if 7/8" suction line is used.

Subcooling Charging in Cooling between 55° F and 120° OD Ambient

American Standard has always recommended installing American Standard approved matched indoor and outdoor systems.

All American Standard split systems are AHRI rated with only TXV or EEV indoor systems.

The benefits of installing approved indoor and outdoor split systems are maximum efficiency, optimum performance and the best overall reliability.

The following charging methods are therefore prescribed for matched systems with indoor TXVs or EEVs.

1. Subcooling (in the cooling mode) is the only recommended method of charging between 55° and 120° ambient temperatures.
2. When charging for ambient temperatures above 120°, charge to 10° subcooling. It is important to return when outdoor ambient temperature is between 55° and 120° to verify system charge per these instructions.
3. For best results — the indoor temperature should be kept between 70° to 80°. Add system heat if needed.
4. Locate the designated subcooling target from the unit nameplate.
5. At startup, or whenever charge is removed or added, the system must be operated for a minimum of (20) minutes to stabilize before accurate measurements can be made.
6. Run the system using the “**Charging Mode-Cooling**” mode found in the 850/950 comfort control. This is the only approved method for setting the system charge level.

Measure Liquid Line Temperature and Refrigerant Pressure at service valves.
7. Determine total refrigerant line length, and height (lift) if indoor section is above the condenser. Follow the Subcool Charging Corrections Table to calculate additional subcooling target value.
8. Locate your liquid line temperature in the left column of the table, and the intersecting liquid line gage pressure under the subcool selection column. Add refrigerant to raise the pressure to match the table, or remove refrigerant to lower the pressure. Always wait (20) minutes for the system conditions to stabilize before adjusting charge again.
9. When system is correctly charged, you can refer to System Pressure Curves to verify typical performance.

Subcool Charging Correction Charts

Figure 1. Subcool Charging Corrections — 2.0 Ton

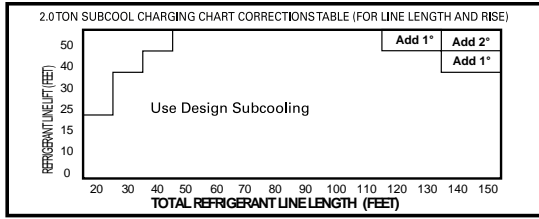

Figure 2. Subcool Charging Corrections — 3.0 Ton

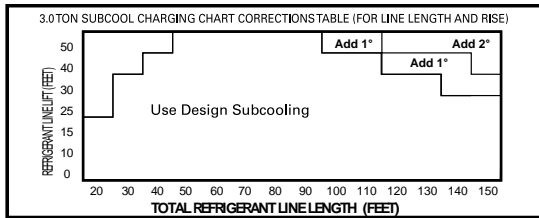

Figure 3. Subcool Charging Corrections — 4.0 Ton

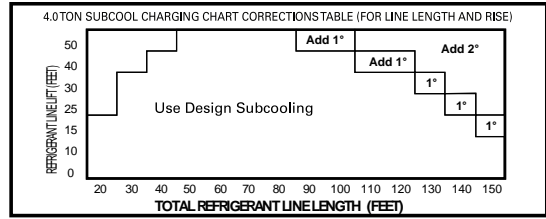
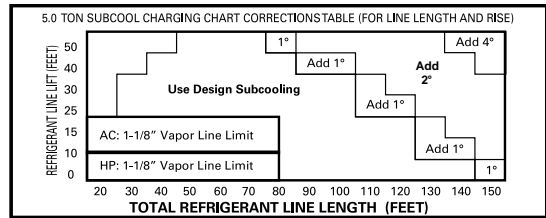

Figure 4. Subcool Charging Corrections — 5.0 Ton



NOTE: 150 ft. length is approved ONLY with 7/8" vapor lines.

Refrigerant Charging Chart

R-410A REFRIGERANT CHARGING CHART							
LIQUID TEMP (°F)	DESIGN SUBCOOLING (°F)						
	8	9	10	11	12	13	14
	LIQUID GAGE PRESSURE (PSI)						
55	179	182	185	188	191	195	198
60	195	198	201	204	208	211	215
65	211	215	218	222	225	229	232
70	229	232	236	240	243	247	251
75	247	251	255	259	263	267	271
80	267	271	275	279	283	287	291
85	287	291	296	300	304	309	313
90	309	313	318	322	327	331	336
95	331	336	341	346	351	355	360
100	355	360	365	370	376	381	386
105	381	386	391	396	402	407	413
110	407	413	418	424	429	435	441
115	435	441	446	452	458	464	470
120	464	470	476	482	488	495	501
125	495	501	507	514	520	527	533
Refer to Service Facts or Installer's Guide for charging method							

Charging: Weigh-In Method

Weigh-In Method can be used for the initial installation, or anytime a system charge is being replaced. Weigh-In Method can also be used when power is not available to the equipment site or operating conditions (indoor/outdoor temperatures) are not in range to verify with the subcooling charging method.

Table 2. Heat Pumps

A	B		C	D
Model	Factory Charge		Charge adder for Indoor Coil	Charge multiplier for interconnecting refrigerant tube length
024	7 lb.	6 oz.	6 oz.	0.6 oz/ft
036	8 lb.	3 oz.	8 oz.	0.6 oz/ft
037	9 lb.	8 oz.	12 oz.	0.6 oz/ft
048	9 lb.	13 oz.	13 oz.	0.6 oz/ft
049	10 lb.	12 oz.	15 oz.	0.6 oz/ft
060	11 lb.	14 oz.	1 lb., 2 oz.	0.6 oz/ft

Table 3. Air Conditioners

A	B		C	D
Model	Factory Charge		Charge adder for Indoor Coil	Charge multiplier for interconnecting refrigerant tube length
024	7 lb.	6 oz.	6 oz.	0.6 oz/ft
036	7 lb.	14 oz.	7 oz.	0.6 oz/ft
037	9 lb.	6 oz.	12 oz.	0.6 oz/ft
048	11 lb.	1 oz.	1 lb., 0 oz.	0.6 oz/ft
060	11 lb.	14 oz.	1 lb., 2 oz.	0.6 oz/ft

Table 4. New Installations – Calculating Charge using the Weigh-In method

<ol style="list-style-type: none"> 1. Measure in feet the distance between the outdoor unit and the indoor unit and record on Line 1. Include the entire length of the line from the service valve to the IDU. 2. Enter the charge multiplier from Column D. 3. Multiply the total length of refrigerant tubing (Line 1) times the value on Step 2. Record the result on Line 3 of the Worksheet. 4. Locate the outdoor equipment size in Column A. Record the value shown in Column C of Table 16 for Heat Pumps or Table 17 for Air Conditioners. 5. Add the values from Step 3 and Step 4 and record the resulting value. This is the amount of refrigerant to weigh-in prior to opening the service valves. 	<p>New Installation Weigh-In Method Worksheet</p> <ol style="list-style-type: none"> 1. Line Length (ft) _____ 2. Value from Column D x _____ 3. Step 1 x Step 2 = _____ 4. Charge Adder (column C) + _____ 5. Refrigerant (Steps 3+4) = _____
--	--

Table 5. Sealed-System Repairs – Calculating Charge using the Weigh-In method.

<ol style="list-style-type: none"> 1. Measure in feet the distance between the outdoor unit and the indoor unit and record on Line 1. Include the entire length of the line from the service valve to the IDU. 2. Enter the charge multiplier from Column D. 3. Multiply the total length of refrigerant tubing (Line 1) times the value on Line 2. Record the result on Line 3 of the Worksheet. 4. Locate the outdoor equipment size in Column A. Record the value shown in Column C of Table 16 for Heat Pumps or Table 17 for Air Conditioners. 5. Record the value in Column B to Line 5 of the Worksheet. 6. Add the values from Step 3, Step 4, and Step 5 and record the resulting value on Line 6. This is the amount of refrigerant to weigh-in. 	<p>New Installation Weigh-In Method Worksheet</p> <ol style="list-style-type: none"> 1. Line Length (ft) _____ 2. Value from Column D x _____ 3. Step 1 x Step 2 = _____ 4. Charge Adder (column C) + _____ 5. Factory Charge (column B) + _____ 6. Refrigerant (Steps 3+4+5) = _____
--	--

Note: The only mode approved for setting or validating system charge is using Charging Mode-Cooling. Charging Mode-Cooling is a variable speed test mode found in the 850/950 comfort control Technician Menu. Outdoor Temperature must be between 55°F and 120°F with Indoor Temperature kept between 70°F and 80°F.

Wiring — D157619P04

LEGEND

- 24 V LINE V FACTORY WIRING (WALL TERMINALS)
- 24 V FIELD WIRING (WALL TERMINALS)
- 24 V FIELD WIRING (FACTORY WIRING)
- MAGNETIC COIL
- EARTH GROUND
- CHASSIS EARTH GROUND
- JUNCTION
- WIRE NUT OR TERMINAL
- THERMISTOR
- INTERNAL OVERLOAD PROTECTION
- PRESSURE ACTIVATED SWITCH
- RESISTOR OR HEATING ELEMENT
- MOTOR WINDING
- SHIELDED CABLE
- POLE OR FEMALE HOUSING (WALL TERMINALS)
- POLE OR MALE HOUSING (WALL TERMINALS)
- POLE OR FEMALE HOUSING (FACTORY WIRING)
- POLE OR MALE HOUSING (FACTORY WIRING)
- COLOUR OF WIRE
- COLOUR OF WIRE
- BK - BLACK
- RD - RED
- OR - ORANGE
- BR - BROWN
- YL - YELLOW
- GR - GREEN
- BL - BLUE
- PK - PINK
- DR - DRAIN
- CS - COIL BOTTOM SENSOR
- CD - COM DISPLAY ASSEMBLY
- CP - COM PRESSURE TRANSDUCER
- EP - ELECTRONIC EXP VALVE
- HPCO - HIGH PRESSURE CUTOUT SWITCH
- OBS - OUTDOOR TEMPERATURE SENSOR
- SP-TRD - SUCTION PRESSURE TRANSDUCER
- SCLEVD - SWITCH OVER VALVE SOLENOID
- TR - TRIP
- PM - PULSE WITH MODULATED COM
- TB - TERMINAL BLOCK
- DTS - DOME TEMPERATURE SENSOR
- CL - COMMUNICATION LINK
- FC - PERMANENT SPLIT CAPACITOR MOTOR CONN
- CS - COIL BOTTOM SENSOR
- LS - LOAD SHED

NOTES:

1. BE SURE POWER SUPPLY AGREES WITH EQUIPMENT NAMEPLATE.
2. POWER WIRING AND GROUNDING OF EQUIPMENT MUST COMPLY WITH LOCAL CODES.
3. LOW VOLTAGE WIRING TO BE NO. 18 AND MINIMUM CONDUCTOR.
4. * ONLY USED ON HEAT PUMP MODELS AND NOT ON AC UNITS

FOR CHAUNAHK INSTALLATIONS
CAUTION: NOT SUITABLE FOR USE ON SYSTEMS EXCEEDING 150V-TO-GROUND ATTENTION-RE CONVERT PAS AUX INSTALLATIONS DE PLUS DE 150 V A LA TERRE

WARNING
 HAZARDOUS VOLTAGE!
 DISCONNECT ALL ELECTRICAL POWER BEFORE SERVICING.
 Failure to disconnect power may result in personal injury or death.

CAUTION
 USE COPPER CONDUCTORS ONLY!
 UNACCEPTABLE WIRE STRANDS OR COILS WILL DAMAGE THE EQUIPMENT.

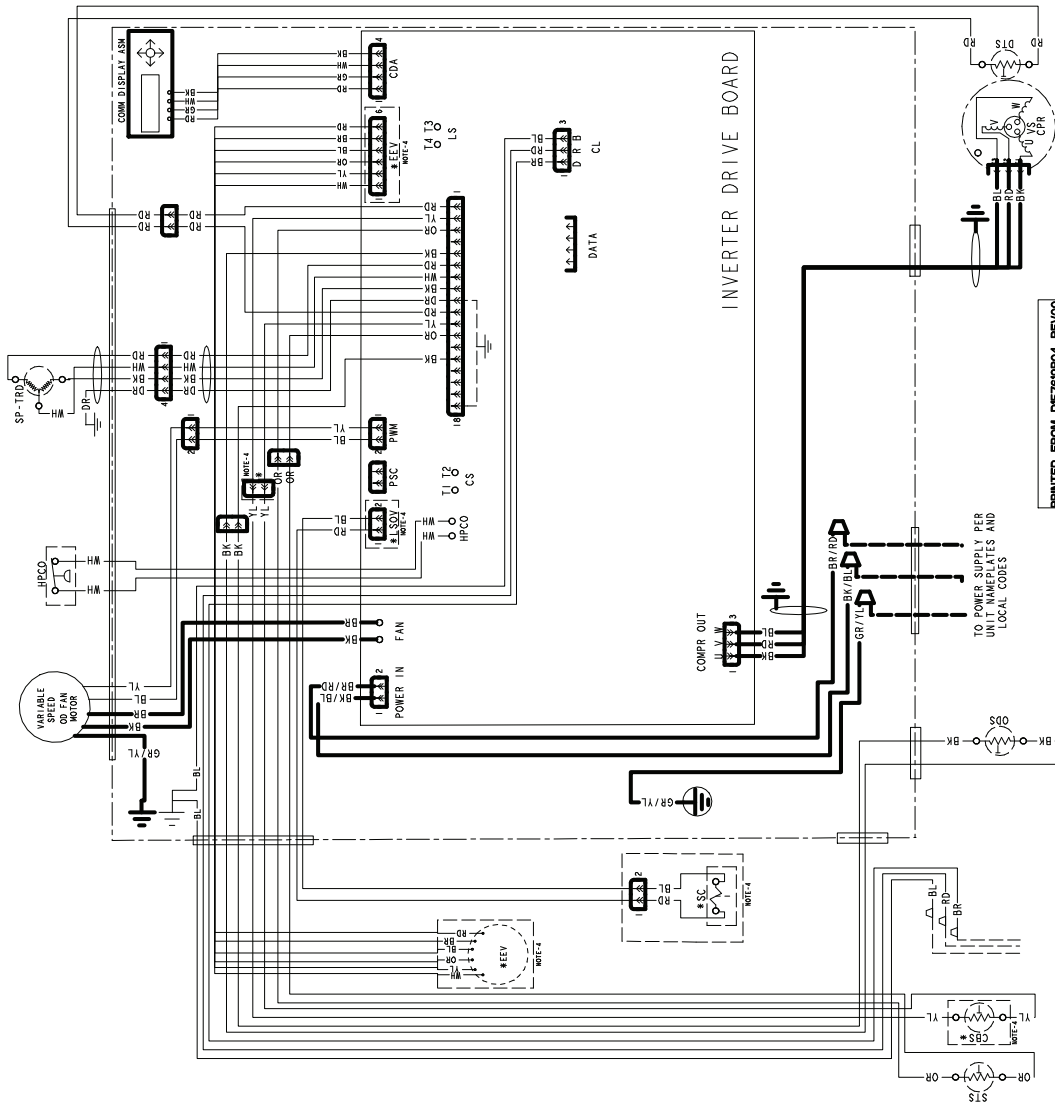

PRINTED FROM DE769P04 REV00

Integrated Variable Speed Control (IVSC) Inputs/Outputs

Also Referred to as "The Drive"

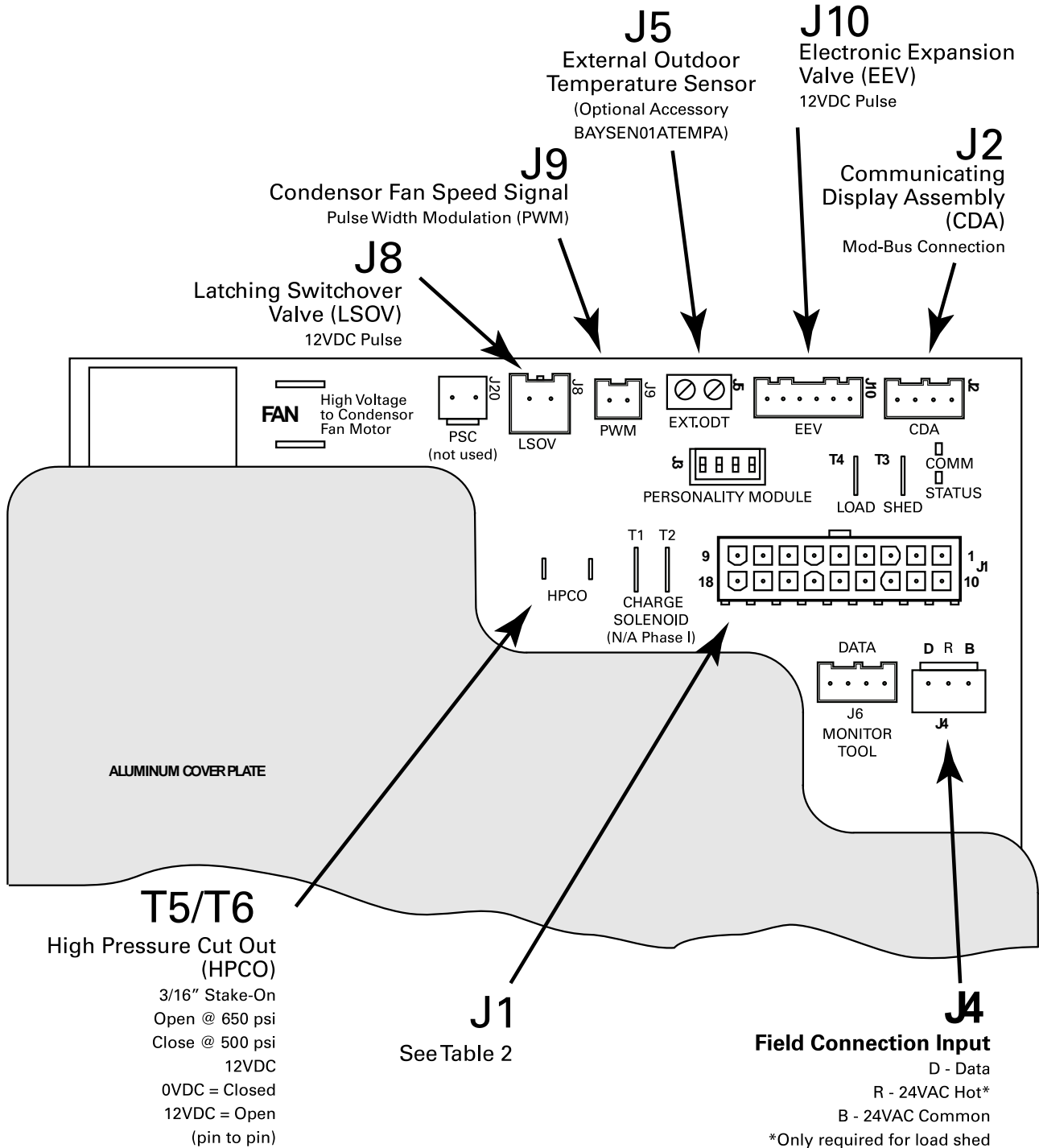

Integrated Variable Speed Control Board LED Indicators

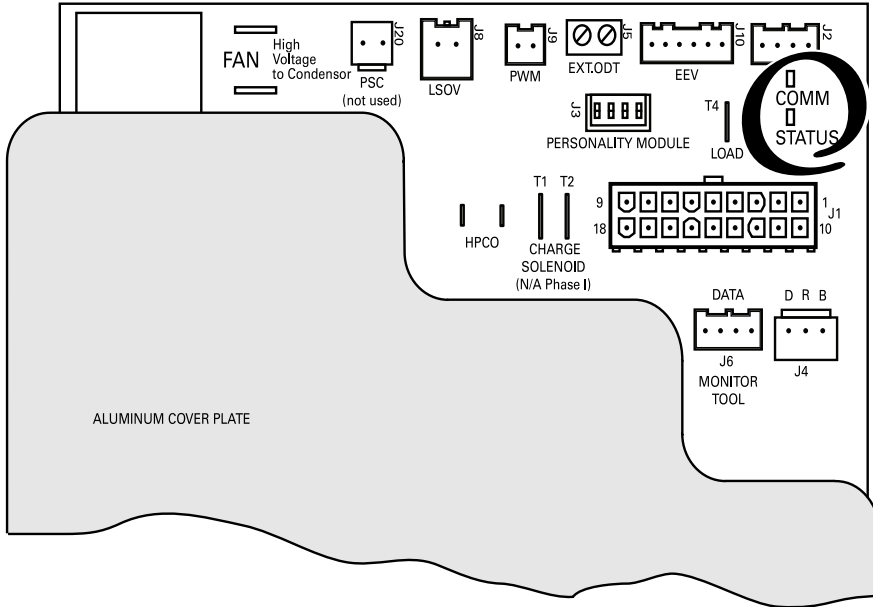

The Status (Green) and COMM (Amber) LEDs are located in the upper right region of the Control Board.

Fault messages are displayed on the CDA

LED'S

LED	RATE	DESCRIPTION	INDICATION
STATUS (GREEN)	SLOW	1 TIME PER SECOND	STANDBY/ IDLE
	MEDIUM	2 TIMES PER SECOND	CALL FOR CAPACITY
	FAST	5 TIMES PER SECOND	POWER UP DELAY
	SOLID ON		TEST MODE
	INTERMITTENT	1 FLASH EVERY 4 SECONDS	HARD LOCKOUT

LED	RATE	DESCRIPTION	INDICATION
COMM (AMBER)	SLOW	1 TIME PER DEVICE	DEVICE COUNT
	FAST	5 TIME PER SECOND	LOSS OF COMMUNICATION

Sump Heat Control

Sump Heat Control Guidelines	
Sump Heat ON	At power up; when outdoor temperature is below 85° F
	When outdoor temperature is below 80° F and compressor dome temperature is less than the outdoor ambient temperature
Sump Heat OFF	When the outdoor temperature goes above 85° F (Sump Heat remains OFF until outdoor temperature drops below 80° F)
	Anytime the compressor is running
	For 50 minutes after each compressor run cycle.

Note: Variable Speed systems are designed so that the compressor and sump heat will not run at the same time. Compressor windings are used for sump heat. When sump heat is active, line-side current will be approximately 1.5 amps. The CDA MONITOR MENU has a field for DRIVE >> DRIVE AMPS which can also be used to verify operation of sump heat.

Sequence of Operation

Control Operational Overview

Operation of the communicating, variable speed outdoor unit is managed and monitored by a micro processor based Integrated Variable Speed Control (IVSC) located in the control box of the outdoor unit. This component is also referred to as "The Drive". Heat and Cool demand messages are transmitted from the comfort control over the data line from the comfort control to the indoor and outdoor sections of the system. System mode and capacity requests are received by the outdoor IVSC and responded to by providing control outputs to the switch-over valve (SOV) solenoid coil, electronic expansion valve (EEV) stepper motor, condenser fan motor and compressor. Operating conditions and system commands such as compressor percent demand, indoor airflow, EEV starting position, defrost (For auxiliary heat), outdoor temperature and alerts are transmitted from the outdoor control over the data line to the rest of the communicating system. Additional data that is communicated to the rest of the system includes the type of equipment installed (variable speed, unit size in nominal tonnage, heat pump or air conditioner) which is used during the Auto Discover function to set indoor airflow and configure the comfort control for the equipment installed

The IVSC has two Light Emitting Diodes (LED) used for indicating operating status and verifying communications. The STATUS LED flash rate indicates if the system is in standby (or idle), receiving capacity demand from the comfort control, in a test mode or in a lockout condition. The COMM LED indicates successful communications by flashing a device count which can be used to verify how many communicating devices are connected to the data line.

A Communicating Display Assembly (CDA) is connected to the IVSC and is used to monitor, configure, test and provide feedback about the system.

Cooling Mode (A/C and Heat Pump)

When a request for cooling capacity is sent from the communicating comfort control to the outdoor unit, the IVSC will respond by flashing the STATUS LED two times per second and the CDA will display COOLING in the SYSTEM STATUS home screen. The IVSC will calculate the required running speed for the compressor and outdoor fan based on the current load value and stage demand sent from the comfort control. Load values under 100 will generate stage one demand and the IVSC will generate power to produce the minimum compressor RPM. Additionally, a CFM demand message is sent from the outdoor IVSC to the indoor unit for matching indoor airflow.

Regardless of the load value or stage demand, the outdoor system will start and ramp to a target startup

speed and hold steady for a minimum dwell period to ensure proper oil return. This dwell period will typically last for 1 minute but for initial start ups, after power is first applied, the dwell period is 15 minutes. The startup operation will progress to normal operation once this dwell period is completed. With stage one demand and minimum compressor RPM, the system will duty cycle as needed to provide the required capacity requested from the comfort control. The default duty cycle setting for stage one demand is 3 Cycles per Hour (CPH). See the Advanced Settings in the 850/950 Installation Guide for more information on CPH.

With any start up, a Pulse Width Modulation (PWM) signal is sent from the J9 plug of the IVSC to the outdoor fan motor to run at the required matching speed.

Should system load value rise above 100, stage two demand is sent from the communicating comfort control to the outdoor control and the IVSC will respond by entering the modulating region of compressor and outdoor fan operation. As load value increases or decreases in the modulating region, so will the compressor, outdoor fan and indoor blower speeds to continuously deliver the capacity requested by the comfort control and meet the demand of the structural load. All indoor CFM demand messages will be sent from the IVSC to the indoor unit so that the blower motor will run with matching modulating speeds. The System Report Screen (Located in the 850/950's Technician Access menu) or the Monitor Menu (Located in the outdoor CDA Technicians Control menu) can be used to view the compressor demand, in percentage, while in the modulating range.

As system load value drops below 100, stage two demand is satisfied and the communicating comfort control returns system operation to stage one demand and the system will begin to duty cycle as needed to provide the requested capacity.

Heat Pump Cooling Mode of Operation

In addition to stage and demand operating sequences outlined in the Cooling Mode description, when a heat pump system receives a demand message for cooling, the Switch Over Valve (SOV) solenoid will be pulsed to position the valve for cooling. Latching Switch Over Valve (LSOV) technology is standard with variable speed outdoor heat pumps. By utilizing components designed to hold the pilot pin of the SOV in place, the valve will maintain the cooling or heating position even when power is removed. Maintaining valve position, or Latching, is accomplished with the help of a magnet mounted in the solenoid coil or a spring manufactured internal to the SOV. To initiate the SOV position, a 12 Volt DC pulse is sent from the J8 plug located on the IVSC to the solenoid coil at the start of each call for capacity. Polarity of the DC pulse is critical to the

direction the valve's pilot pin will be set. Always follow the red and blue color coding to ensure proper polarity.

Heat pumps are also equipped with an Electronic Expansion Valve (EEV) which will be set to the "Check Valve Position" and drive wide open. The EEV does not provide refrigeration control in the cooling mode of operation.

Heat Pump Heating Mode of Operation

When a request for heating capacity is sent from the communicating comfort control to the outdoor unit, the IVSC will respond by flashing the STATUS LED two times per second and the CDA will display HEATING in the SYSTEM STATUS home screen.

In the heating mode of operation the LSOV solenoid will be pulsed to position the valve for heating at the start of each call for capacity.

During heating mode, the EEV will be in the controlling state. Refrigerant flow is managed by incrementally opening or closing the valve to control compressor superheat under a wide range of conditions. Superheat is calculated with feedback to the IVSC from a suction line temperature sensor and a suction line pressure transducer. The IVSC will target 10 degrees (+/-2) of superheat and drive a valve position by periodically pulsing the stepper motor and then monitoring compressor superheat results. Control signals to the EEV stepper motor are 12 volt DC pulses from J10 on the IVSC. The EEV step position and compressor superheat can be monitored through the CDA monitor menu during runtime operation. The IVSC will close the EEV with every OFF cycle and drive the valve to wide open during defrost or cooling mode of operation.

Note: *When a heat pump system is first powered up, the EEV produces an audible sound (soft ratcheting sound) as the valve drives to the closed position.*

Defrost Mode from Cycling-Stage

When the system is operating in cycling-stage and the control initiates a Defrost, the indoor control simultaneously:

- De-energizes the PWM signal to the outdoor fan motor,
- Drives the OD EEV to full open and,
- Commands the SOV to change to the cooling mode.

There is a brief switchover time-delay (to allow refrigerant pressures to stabilize) before the compressor is commanded to run at Maximum Speed Cooling to perform Defrost.

The outdoor control also sends a demand message to the indoor unit to run the blower at Maximum Speed Cooling and energize auxiliary heat (if equipped). Auxiliary heat blower speed may be higher than Maximum Speed Cooling and will take precedence during defrost.

The Defrost Mode will be terminated after the OD coil temperature reaches 47°F or the maximum time override of 15 minutes has lapsed. At Defrost termination, the compressor will be commanded to go to the Defrost Switchover Speed. After the lower speed is achieved, the SOV position will be changed back to the heating mode of operation and the OD fan will be turned back on. Following the refrigerant stabilizing delay, the compressor will be allowed to run at any speed commanded by thermostat demand.

The outdoor control will send the necessary pulse signals to the stepper motor coil returning the EEV to a controlling position that matches capacity demand and begin monitoring superheat.

Defrost Mode from Modulating-Stage

When the system is operating in modulating-stage and the control initiates a Defrost, the outdoor control commands the compressor to go to the Defrost Switchover Speed.

After the lower speed is achieved, the SOV will be switched into the cooling mode and the control will simultaneously de-energize the PWM signal to the outdoor fan motor and drive the OD EEV to full open.

There is a brief switchover time-delay (to allow refrigerant pressures to stabilize) before the compressor is commanded to run at Maximum Speed Cooling to perform Defrost.

The outdoor control also sends a demand message to the indoor unit to run the blower at Maximum Speed Cooling and energize auxiliary heat (if equipped). Auxiliary heat blower speed may be higher than Maximum Speed Cooling and will take precedence during defrost.

The CDA will show DEFROST in the Home Screen.

The Defrost Mode will be terminated after the OD coil temperature reaches 47°F or the maximum time override of 15 minutes has lapsed. At Defrost termination, the compressor will be commanded to go to the Defrost Switchover Speed. After the lower speed is achieved, the SOV position will be changed back to the heating mode of operation and the OD fan will be turned back on. Following the refrigerant stabilizing delay, the compressor will be allowed to run at any speed commanded by thermostat demand.

The outdoor control will also send the necessary pulse signals to the stepper motor coil returning the EEV to a controlling position that matches capacity demand and begin monitoring superheat.

The system will stay in the Defrost, Maximum Speed Cooling even if the comfort control demand changes from modulating-stage to cycling-stage. However, the system will shut down if the comfort control demand message for cycling-stage capacity ends. The system will continue the current defrost cycle the next time the comfort control sends a demand message for compressor heat.

Defrost Control (Heat Pump only)

Demand Defrost

The demand defrost control measures heat pump outdoor ambient temperature with a sensor located outside the outdoor coil. A second sensor located on the outdoor coil is used to measure the coil temperature. The difference between the ambient and the colder coil temperature is the difference or delta-T measurement. This delta-T measurement is representative of the operating state and relative capacity of the heat pump system. By measuring the change in delta-T, we can determine the need for defrost. The coil sensor also serves to sense outdoor coil temperature for termination of the defrost cycle.

Fault Identification

A fault condition is indicated by the CDA connected to the control board inside the heat pump control box.

Defrost Enabled

Demand Defrost is enabled with the following inputs to the Integrated Variable Speed Control (IVSC):

- Outdoor ambient temperature sensor (ODS-B) reporting an outdoor temperature at or below 52° F.
- Coil temperature sensor (CBS) reporting a coil temperature at or below 35° F.
- Heat/Cool Demand (HCD) from the communicating comfort control for at least two minutes or more.

Defrost Initiation

The calculated temperature difference between the outdoor temperature sensor and the coil temperature sensor is called Delta T. Defrost can occur once the current Delta T exceeds the Delta T initiate value. The Defrost initiate value is calculated using a clean-coil Delta T x 2.0, plus a temperature bin correction factor. Initiation Delta T will automatically adjust based on the outdoor temperature. This adaptive logic assures a complete defrost for a range of outdoor temperatures.

DEFROST TERMINATION PROFILES

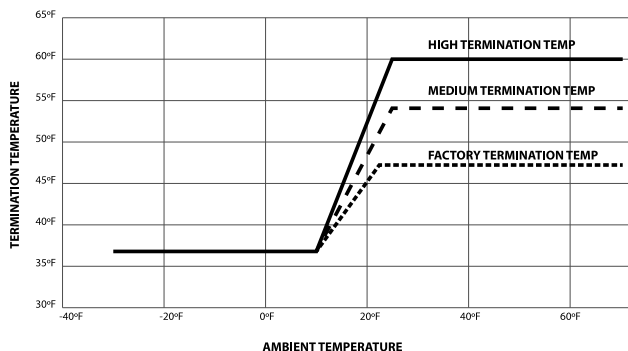

CDA Navigation to Forced Defrost

Figure 5. CDA Mini Menu

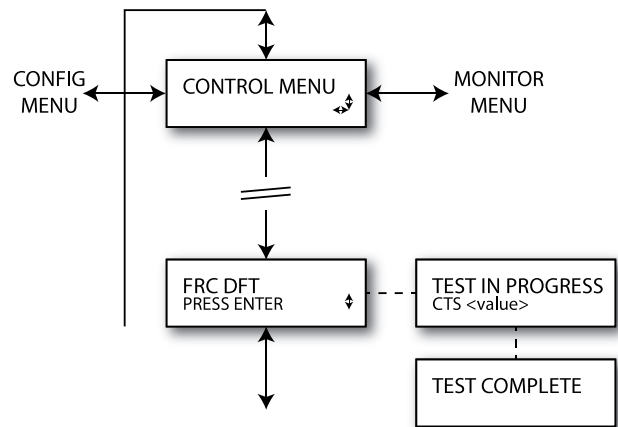

NOTES: Forced Defrost

1. System must be running with demand from the thermostat.
2. FRC DFT TEST can be initiated in heat mode only.
3. Press ENTER to begin forced defrost.
4. Execute Forced Defrost following Forced Defrost (Defrost terminates on Coil Temperature or maximum time override of 15 minutes).
5. When test begins, TEST IN PROGRESS displays on line 1 and Coil Temperature value on line 2.

Note: Home Screen, under System Status will display DEFROST.

6. When test is complete, TEST COMPLETE displays for 10 seconds.
7. If there is a defrost fault condition, test terminates and sends alert to the alert menu.
8. For more information, refer to the Alert Code Tables in Service Facts and Technical Service Manual (Pub. No. 34-4301-01) documents.

Note: Screens will update as the test proceeds.

SENSORS

Compressor Dome Temperature

This table shows the corresponding voltage, resistance and temperature readings for the Dome Temperature Sensor when measured across pins 1 and 10. The power source for the Dome Temperature Sensor is 3.2VDC.

TEMP F	TEMP C	THERMISTOR RESISTANCE (OHMS)	VOLTS DC (PIN TO PIN)
-15	-26.11	139453	3.13
-10	-23.33	118062	3.11
-5	-20.56	100258	3.10
0	-17.78	85393	3.08
5	-15.00	72944	3.06
10	-12.22	62487	3.04
15	-9.44	53676	3.02
20	-6.67	46232	2.99
25	-3.89	39925	2.96
30	-1.11	34567	2.93
35	1.67	30003	2.89
40	4.44	26105	2.85
45	7.22	22767	2.80
50	10.00	19903	2.75
55	12.78	17438	2.70
60	15.56	15312	2.64
65	18.33	13475	2.58
70	21.11	11883	2.51
75	23.89	10501	2.45
80	26.67	9298	2.37
85	29.44	8249	2.30
90	32.22	7333	2.22
95	35.00	6530	2.14
100	37.78	5826	2.06
105	40.56	5208	1.97
110	43.33	4663	1.89
115	46.11	4182	1.80
120	48.89	3758	1.72
125	51.67	3382	1.63
130	54.44	3048	1.55
135	57.22	2752	1.47
140	60.00	2488	1.39
145	62.78	2253	1.31
150	65.56	2043	1.24
155	68.33	1856	1.17
160	71.11	1688	1.10
165	73.89	1537	1.03
170	76.67	1402	0.97
175	79.44	1280	0.91
180	82.22	1170	0.85
185	85.00	1071	0.80
190	87.78	982	0.74
195	90.56	901	0.70
200	93.33	828	0.65
205	96.11	762	0.61
210	98.89	702	0.57
215	101.67	647	0.53

TEMP F	TEMP C	THERMISTOR RESISTANCE (OHMS)	VOLTS DC (PIN TO PIN)
220	104.44	597	0.50
225	107.22	552	0.47
230	110.00	511	0.44
235	112.78	473	0.41
240	115.56	438	0.38
245	118.33	407	0.36
250	121.11	378	0.33
255	123.89	351	0.31
260	126.67	327	0.29
265	129.44	304	0.27
270	132.22	284	0.26
275	135.00	265	0.24
280	137.78	247	0.23
285	140.56	231	0.21
290	143.33	216	0.20
295	146.11	203	0.19
300	148.89	190	0.18
305	151.67	178	0.17
310	154.44	167	0.16
315	157.22	157	0.15
320	160.00	148	0.14
325	162.78	139	0.13
330	165.56	131	0.12

Figure 6. Dome Temperature Sensor Pin 1 & 10 (Red)

Integrated Variable Speed Control Board

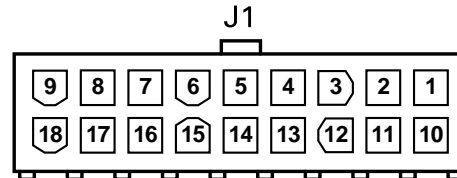

A working Compressor Dome Temperature Sensor is required for:

- Protection (High/Low Temperature)
- Preheating (Sump Heat)
- Outdoor EEV Control
- Diagnostics; Reverse rotation, Flooding, Charge Level

The Dome Temperature Sensor control contains an NTC thermistor input for sensing the Compressor Dome Temperature. The thermistor has a nominal resistance of $\approx 10k$ ohms at 75°F. The minimum range required for the Dome Temperature input is -31°F to 302°F when measured across pins 1 and 10.

Note: Secure Installation of Dome Sensor is required for reliable compressor & system operation.

SENSORS

Ambient Temperature Sensor (ODS)

These tables show the corresponding voltage, resistance and temperature readings for the Ambient, Temperature Sensor when measured across pins 5 & 14.

The power source for the Ambient, Coil and Suction Temperature sensors is 3.2VDC

TEMP F	TEMP C	THERMISTOR RESISTANCE (OHMS)	VOLTS DC
-15	-26.11	135976	2.43
-10	-23.33	115112	2.33
-5	-20.56	97745	2.22
0	-17.78	83247	2.11
5	-15.00	71108	1.99
10	-12.22	60916	1.87
15	-9.44	52334	1.75
20	-6.67	45088	1.63
25	-3.89	38952	1.52
30	-1.11	33742	1.40
35	1.67	29307	1.29
40	4.44	25520	1.19
45	7.22	22280	1.09
50	10.00	19499	1.00
55	12.78	17108	0.91
60	15.56	15045	0.83
65	18.33	13262	0.75
70	21.11	11717	0.68
75	23.89	10375	0.62
80	26.67	9207	0.56
85	29.44	8188	0.51
90	32.22	7297	0.46
95	35.00	6516	0.42
100	37.78	5830	0.38
105	40.56	5227	0.35
110	43.33	4695	0.31
115	46.11	4224	0.29
120	48.89	3808	0.26
125	51.67	3439	0.24
130	54.44	3111	0.21
135	57.22	2820	0.20
140	60.00	2559	0.18

Figure 7. Ambient Temperature Sensor Pins 5 & 14 (Black)

Integrated Variable Speed Control Board

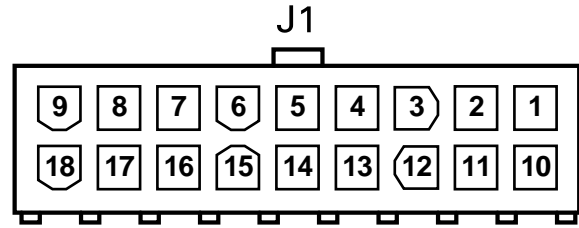

The Ambient Temperature Sensor control has an NTC thermistor input for sensing the outdoor air temperature and has a nominal resistance of $\approx 10k$ ohms at 75°F. The Ambient Temperature is measured across pins 5 and 14. The minimum range required for the Ambient Temperature Sensor is -40°F to 140°F .

A working Ambient Temperature Sensor is required for the following:

- Low Pressure Monitoring
- Defrost (Heat Pump)
- Comfort Control Display (Outdoor Air Temperature)
- Aux Heat Control During Defrost (Heat Pump)
- Aux Heat Lockout
- Compressor Lockout (Heat Pump)
- Oil Management
- Humidifier Dew-Point Control
- OD EEV Startup Position
- ID EEV Startup Position
- Pre Heating (Sump Heat)
- Normal Operation of the ID and OD Fan
- Diagnostics

Coil and Suction Temperature Sensor

TEMP F	TEMP C	THERMISTOR RESISTANCE (OHMS)	VOLTS DC
-15	-26.11	135976	2.71
-10	-23.33	115112	2.64
-5	-20.56	97745	2.56
0	-17.78	83247	2.48
5	-15.00	71108	2.38
10	-12.22	60916	2.29
15	-9.44	52334	2.19
20	-6.67	45088	2.08
25	-3.89	38952	1.97
30	-1.11	33742	1.86
35	1.67	29307	1.75
40	4.44	25520	1.64
45	7.22	22280	1.53
50	10.00	19499	1.42
55	12.78	17108	1.32
60	15.56	15045	1.22
65	18.33	13262	1.13
70	21.11	11717	1.04
75	23.89	10375	0.96
80	26.67	9207	0.88
85	29.44	8188	0.81
90	32.22	7297	0.74
95	35.00	6516	0.68
100	37.78	5830	0.62
105	40.56	5227	0.57
110	43.33	4695	0.52
115	46.11	4224	0.47
120	48.89	3808	0.43
125	51.67	3439	0.40
130	54.44	3111	0.36
135	57.22	2820	0.33
140	60.00	2559	0.30

**Figure 8. Coil Temperature Sensor
Pins 2 & 11 (Yellow)**

Integrated Variable Speed Control Board
J1

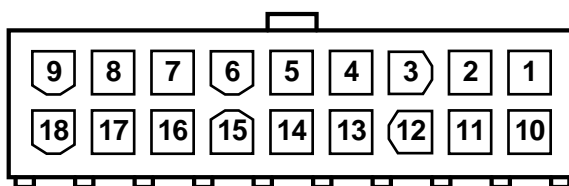

The Coil Temperature Sensor control has an NTC thermistor input for sensing the coil temperature. This reading is used by the defrost algorithm on heat pump units. The thermistor has a nominal resistance of 10k ohms at 75°F. The minimum range and resolutions as measured across pins 2 and 11 required for Coil Temperature Sensor is -50°F to 150°F

A working Coil Temperature Sensor is required for the following:

- Defrost Initiation and Termination
- Compressor Sump Heat (Preheating)
- Diagnostics; Charge Level, Indoor/Outdoor Airflow

**Figure 9. Suction Temperature Sensor
Pins 3 & 12 (Orange)**

Integrated Variable Speed Control Board
J1

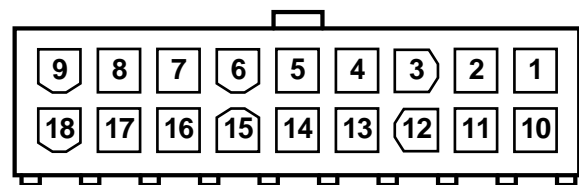

The Suction Temperature Sensor control utilizes an NTC thermistor input for sensing the suction/gas temperature. The thermistor has a nominal resistance of ≈ 10k ohms at 75°F. The minimum range and resolutions as measured across pins 3 and 12 required for the Suction Temperature Sensor is -50°F to 150°F

A working Suction Temperature Sensor is required for:

- Outdoor EEV Control (Target Super Heat)
- Diagnostics; Charge level, Indoor/Outdoor Airflow

SENSORS

Suction Line Pressure Transducer

This table shows the corresponding voltage and pressure readings for the Suction Line Pressure Transducer when measured across pins 7 and 8.

PRESSURE (PSIG)	VOLTS DC PIN 7 TO PIN 8
10	0.60
20	0.70
31	0.81
41	0.91
51	1.00
60	1.10
70	1.20
82	1.32
92	1.42
101	1.52
111	1.62
120	1.72
130	1.81
140	1.91
152	2.03
161	2.13
171	2.23
181	2.33
190	2.43
200	2.52

A working Suction Pressure Sensor is required for the following:

- Start Up (Pressure Limits)
- Low Pressure, Loss of Charge Protection
- Indoor Coil Freeze Protection
- Outdoor EEV Control (Target Super Heat)
- Diagnostics; Reverse Rotation, Charge Level, Indoor/Outdoor Airflow

The Suction Pressure Transducer control is measured across pins 7 and 8 and has an active 0–4.9VDC transducer input for sensing low suction pressure.

DESCRIPTION	LOCATION	WIRE COLOR
4.9 VDC POWER	PIN 6	RED
OUTPUT	PIN 7	WHITE
COMMON	PIN 8	BLACK
GROUND	PIN 9	GREEN

Figure 10. Suction Pressure Transducer Pins 7 (White) & 8 (Black)

Integrated Variable Speed Control Board

J1

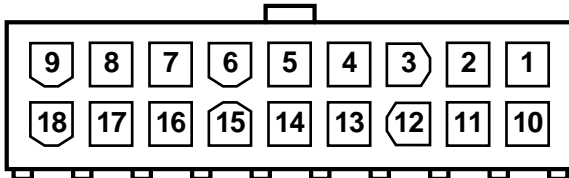

Variable Speed Alert Codes

Alert Code	Alert Group	Display Assembly Text	Sub-alar-m	A/TZONE 850/950	State action on occurrence	State action on clearance	Alert Description	Possible Cause
18	Control Failure	CTRL FLT	4	Err 18.04	Shutdown. Send Err code to thermostat and Fault text to CDA	Resume normal operation.	Internal control error is detected	Control failure, replace IVSC
67	Temp Sensor Fault	AMB T SENSE	0	Err 67.00	For Cooling mode, "Assume Ambient Temp" as per Limp along mode and Continue normal operation. For Heating mode, go to timed defrost.	With actual ambient temperature, continue normal operation. For Heating mode, follow demand defrost algorithm	Ambient Temperature Sensor alert	Ambient Sensor out-of-range (Open/Shorted/Missing)
		COILT SENSE	1	Err 67.01	For Cooling mode, continue normal operation. For heating mode, go to timed defrost.	For Cooling mode, continue normal operation. For heating mode, go to timed defrost.	Coil Temperature Sensor alert	Coil Sensor out-of-range (Open/Shorted/Missing)
		EXT T SENSE	3	Err 67.03	Cooling - Normal operation	Continue normal operation	External Temperature Sensor alert	Ext Sensor out-of-range (Shorted) Open/ Missing revert to Ambient Sensor input
		DOME T SENSE	4	Err 67.04	Cooling - Normal operation	Continue normal operation	Dome Temperature Sensor is faulted in Cooling mode	Dome Sensor out-of-range (Open/Shorted/Missing)
		DOME T SENSE	5	Err 67.05	Heating - Limp along mode of constant speed (compressor speed is limited to 2400 RPM)	Ramp up to demand speed and resume normal operation.	Dome Temperature Sensor is faulted in Heating mode	Dome Sensor out-of-range (Open/Shorted/Missing)
		SUCT T SENSE	6	Err 67.06	Cooling - Normal operation	Continue normal operation	Suction Temperature Sensor is faulted in Cooling mode	Suction Sensor out-of-range (Open/Shorted/Missing)
		SUCT T SENSE	7	Err 67.07	Heating - Limp along mode of constant speed (Compressor speed is limited to 2400 RPM, EEV is locked to safe position)	Ramp up to demand speed and resume normal operation.	Suction Temperature Sensor is faulted in Heating mode	Suction Sensor out-of-range (Open/Shorted/Missing)
		CDT UNATCHD	8	Err 67.08	Heating - Limp along mode of constant speed (compressor speed is limited to 2400 RPM)	Ramp up to demand speed and resume normal operation.	Compressor Dome Temperature Sensor not attached to Compressor (Heating Mode)	Compressor Dome Temperature Sensor not attached to Compressor (Heating Mode) Introduced with AOC Software Version 2, Fall of 2014)
68	Defrost Fault	DFT FAULT A	0	N/A	As defined in Defrost algorithm	Continue normal operation	Defrost Fault A has been detected	Low heat pump capacity (Inoperative compressor, loss of charge, shorted coil sensor, open ambient sensor)
		DFT FAULT B/C	1	N/A	As defined in Defrost algorithm	Continue normal operation	Defrost Fault B or C has been detected	Fault B indicates 10 defrosts terminated on time override. Fault C indicates sensor High Delta T.
		DFT FAULT A(B/C)	2	N/A	As defined in Defrost algorithm	Continue normal operation	Defrost Fault A and B or A and C have been detected	Within a given length of time, both faults existed

Variable Speed Alert Codes

Alert Code	Alert Group	Display Assembly Text	Sub-alarm	A/TZONE 850/950	State action on occurrence	State action on clearance	Alert Description	Possible Cause
80	High Pressure Monitor Fault	HP SHORT LO	0	"Wait"	5 min of compressor lockout and send "WAIT" to thermostat	Restart with reduced capacity. (Capacity reduced by 1/5 with each occurrence)	High pressure switch has tripped resulting in a High Pressure Short Lock Out. (HPCO limit = 650psig)	Overcharged. Cooling Mode: Outdoor Fan Failure, clogged coil, recirculation, excessive high ambient, non condensable. Heating Mode: Indoor Fan Failure, clogged coil, non condensable.
80	High Pressure Monitor Fault	HP HARD LO	1	Err 80.01	Lockout compressor operation until power cycle, No system operation	Can be cleared only on power cycle. After power cycle, the compressor shall resume normal operation.	6 High Pressure Short Lock Out events have occurred resulting in a High Pressure Hard Lock Out. (High Pressure Limit = 650psig)	Overcharged. Cooling Mode: Outdoor Fan Failure, clogged coil, recirculation, excessive high ambient, non condensable. Heating Mode: Indoor Fan Failure, clogged coil, non condensable.
		HP RED RPS	2	"Wait"	On restart, after short lockout, compressor will operate at reduced capacity and this alert is declared. (Message on Tstat informing of reduced capacity) Note: Recover reduced capacity with each 2 hr run time window without an HPCO trip.	Normal operation resumes.	High Pressure trip point has been exceeded and a 5 minute time out has been enforced. Restart is allowed but with reduced capacity.	Overcharged. Cooling Mode: Outdoor Fan Failure, clogged coil, recirculation, excessive high ambient, non condensable. Heating Mode: Indoor Fan Failure, clogged coil, non condensable.
88	Ground fault	GND FAULT LO	1	Err 88.01	Emergency shutdown. Drive will protect itself.	Can be cleared only on power cycle. After power cycle, the compressor shall resume normal operation.	Grounding issue from output of the drive. If the sum of all three currents exceeds 10 amp to ground	Burnt winding, faulty current sensor, internal board short, pinched compressor lead (shorted). Run Drive Test. (GoTo "Compressor Verification" troubleshooting flow chart)
90	Communication Busy Fault	SYS COM BUSY	2	Err 90.02	CLII bus must go idle. Continue to operate normally	Resume normal operation	Communication busy	R & B to thermostat reversed polarity
91	Communication Fault	SYS COM ERR	2	Err 91.02	Shutdown if Heat/Cool demand message not received for 3 reporting intervals.	Resume normal operation	Loss of Heat/Cool demand message	Open/Shorted Data line Check for reversed polarity
		NO SYS CLK	3	Err 91.03	Shutdown	Resume normal operation	Loss of Bit Master	Bit Master Control Fault
106	External Shutdown Fault	EXT SW OPEN	1	"Load Shed"	Compressor cooling operation shall not be allowed.	Resume normal operation. Cooling operation allowed.	External shutdown switch is Active and input at T3 to T4 is open	External Load Shed device is active with external switch configured to Active and input at T3 to T4 is open

Variable Speed Alert Codes

Alert Code	Alert Group	Display Assembly Text	Sub-alarm	A/TZONE 850/950	State action on occurrence	State action on clearance	Alert Description	Possible Cause
114	Bad or Missing PM	PM DATA ERR	0	N/A	Continue normal operation	Continue normal operation	PM data corrupt	PM Error
		PM MISSING	3	Err 114.03	Continue normal operation	Continue normal operation	PM missing with good local copy	PM Error
		PM UNIT ERR	4	N/A	Continue normal operation	Continue normal operation	Bad data in PM with good local copy	PM error
		PM MEM ERR	5	Err 114.05	Shutdown. No compressor operation until a good PM is inserted.	Resume normal operation	Bad data in PM with no local copy	PM Error
		PM MISSING	6	Err 114.06	Shutdown. No compressor operation until a good PM is inserted.	Resume normal operation	PM bad or missing with no local copy	PM Error
155	Outdoor EEV Motor Fault	EEV MTR ERR	2	Err 155.02	Can not run in Heating mode, Can run in Cooling mode	Power cycle	The OD EEV electric coil has an open or intermittent short circuit.	EEV motor coil open or shorted
156	System Low Charge Fault	LOW CHARGE	1	N/A	High Superheat occurrences	Superheat Change occurs and allows control within the EEV range of operation. (Superheat target is 10 degrees +/- 4)	High Superheat occurrence of 35 degrees or more has been detected for more than 60 minutes.	System low charge, liquid line restriction, sensor calibration
159	Unit Bus Fault	IPC3 COM ERR	5	Err 159.05	OD Continue normal operation	Continue normal operation. Technician interface available	Display Assembly communication error	Wire assembly between Display Assembly and IVSC board
164	Outdoor EEV Valve Migrated Open	EEV OPEN ERR	2	N/A	The valve is not responding to a change in position, EEV supposedly opened fully and no change to accommodate superheat occurred.	Superheat Change occurs and allows control within the EEV range of operation	EEV migrated to open position but superheat is not at the desired set point. Valve is not responding to a change in position.	Possible stuck valve or sensor(s) out of calibration
	Outdoor EEV Valve Migrated Closed	EEV CLSE ERR	3	N/A	The valve is not responding to a change in position, EEV supposedly closed fully and no change to accommodate superheat occurred.	Superheat Change occurs and allows control within the EEV range of operation	EEV migrated to closed position but superheat is not at the desired set point. Valve is not responding to a change in position.	Possible stuck valve or sensor(s) out of calibration
165	Low Superheat Error	LO SUPERHEAT	1	N/A	Low Superheat occurrences	Superheat Change occurs and allows control within the EEV range of operation	Low super heat (less than 3 degrees) has been detected for more than 60 minutes	Possible stuck valve, sensor(s) out of calibration, low airflow, overcharge, check valve leaking.
166	Low Superheat Error	LO SUPERHEAT	1	N/A	Low Superheat with EEV closed	Superheat Change occurs and allows control within the EEV range of operation	EEV valve closed and still flooding	Possible stuck valve, sensor(s) out of calibration, low airflow, overcharge, check valve leaking.
172	Key fault	KEY FAULT	1	N/A	OD continue normal operation. CDA shall quit generating key events and will stay on same screen till timeout and then jump to default screen.	Continue normal operation. Technician interface available	Display Assembly has a stuck key	Faulty Display Assembly
174	Suction Pressure Sensor Fault	SUCT P SENSE	0	Err 174.00	Shutdown and enter a hard lockout. Compressor locked out until power cycle and requires service call.	Power cycle. After power cycle, the compressor shall resume normal operation.	Pressure transducer is missing, open, shorted or out of range.	Wiring or component failure. (System under vacuum or suction pressure over 500psig)

Variable Speed Alert Codes

Alert Code	Alert Group	Display Assembly Text	Sub-alar-m	A/TZONE 850/950	State action on occurrence	State action on clearance	Alert Description	Possible Cause
175	Limp Along Mode	LIMP MODE	0	Err 175.00	High or Low superheat detected for at least 20 minutes. Limp Mode can also be triggered by Loss of Sensor reading. Look for Sensor Error. Limit Compressor Speed to a constant value.	Ramp up to demand speed (normal operation)	High or Low superheat detected for at least 20 minutes. Limp Mode can also be triggered by Loss of Sensor reading. Look for Sensor Error. Limit Compressor Speed to a constant value.	Problem with refrigerant pressure or flow (high or low superheat). Sensor Faulted (out of range). Dome temp, suction temp, ambient temp, indoor EEV temp sensor (EEV in safe mode).
		LIMP MOD LO	1	Err 175.01	Loss of Suction Pressure Transducer reading forces shut down and Hard Lock	Can be cleared only on power cycle. After power cycle, the compressor shall resume normal operation.	Shutdown. Can't start system without Service being called. Send error to thermostat and alert menu in CDA	Failed suction pressure transducer, or multiple simultaneous sensor failures. Evaluate sensor failure alerts for troubleshooting / resolution.
176	Modbus Communication Failure	DRV COMM LO	0	Err 176.00	With communication error message, the drive must shut down.	Can be cleared only on power cycle. After power cycle, the compressor shall resume normal operation.	Loss of internal communication within the Drive.	Loss of internal communication within the Drive. On a persistent 176.00 error, the technician should cycle power to the ODU. If error 176.00 returns, replace the Drive. If replacement Drive has the same issue, investigate for EMI and source.
177	Drive Current Failure	CUR DER	0	N/A	Compressor speed Derated.	Ramp up to demand speed (normal operation).	Internal Derate is active due to high Drive output current	High load conditions.
		CUR EX DER	1	Err 177.01	Compressor speed Derated. This alert shall be an indication of an extended Derated performance.	Ramp up to demand speed (normal operation).	Drive current is above threshold and the system is being Derated for an extended period of time.	High load conditions.
		SW CUR CO	2	"Wait"	Emergency shutdown. Control will clear the fault and retry every 5 minutes.	Resume normal operation	Drive output current exceeds internal limit set for current sensor	High load condition. Overcharge, dirty coil (s), low airflow, recirculation, compressor failure, Drive hardware failure (Run Drive Diagnostics).
		HW CUR CO	3	"Wait"	Emergency shutdown. Control will clear the fault and retry every 5 minutes.	Resume normal operation	Drive output current exceeds internal limit set for current sensor	Compressor failure (locked rotor, shorted windings), Drive hardware failure (Run Drive Diagnostics)
		CURRENT LO	4	Err 177.04	Emergency shutdown	Can be cleared only on power cycle. After power cycle, the compressor shall resume normal operation.	5 occurrences of HW CUR CO in 1 hour, or 15 occurrences of SW CUR CO in 1 hour. Each hour of runtime without a HW or SW cutout will reduce the total count by 1.	High load conditions for 5 consecutive over current cutout periods. GoTo Drive Diagnostic Test in CDA. Also see Compressor Verification Flowchart. Choke possibly not plugged in.

Variable Speed Alert Codes

Alert Code	Alert Group	Display Assembly Text	Sub-alar-m	A/TZONE 850/950	State action on occurrence	State action on clearance	Alert Description	Possible Cause
178	DC Voltage Failure	DC HI CO	0	"Wait"	Emergency shutdown. Control will clear the fault and retry every 5 minutes.	Resume normal operation	DC bus voltage is greater than 480VDC	PFC hardware failure. Run Drive Diagnostic Test to verify failure. Call for tech support, record failure mode for warranty claimbefore replacing Drive. This error can occur after a power disconnect.
		DC LOW CO	1	"Wait"	Emergency shutdown. Control will clear the fault and retry every 5 minutes.	Resume normal operation	DC bus voltage is less than 220VDC	Low line voltage. Verify supply voltage is between 187VAC and 253VAC. This error can occur after a power disconnect.
		DC EXC HI LO	2	Err 178.02	DC Voltage Hi Lockout has occurred 10 times consecutively. Control will clear the fault and retry every 5 minutes.	Control will clear fault when condition no longer exists (DC bus voltage is less than 480VDC).	DC Bus excessive over voltage after 10 consecutive 5 minute cutouts (178.00)	PFC hardware failure. Run Drive Diagnostic Test to verify failure. Call for tech support, record failure mode for warranty claimbefore replacing Drive. This error can occur after a power disconnect.

Variable Speed Alert Codes

Alert Code	Alert Group	Display Assembly Text	Sub-alarm	A/TZONE 850/950	State action on occurrence	State action on clearance	Alert Description	Possible Cause
179	Power Module Temperature Failure	REC TEMP DER	0	N/A	Compressor speed Derated.	Ramp up to demand speed (normal operation).	Rectifier temperature greater than the Derate threshold	High Load condition, heat sink performance loss (check thermal grease, cold plate torque)
		REC T EX DER	1	Err 179.01	Compressor speed Derated. This alert shall be an indication of an extended Derated performance.	Ramp up to demand speed (normal operation).	Rectifier temperature greater than the Derate threshold and the system is being Derated for an extended period of time	High Load condition, heat sink performance loss (check thermal grease, cold plate torque) possible Drive hardware failure (Run Drive diagnostics)
		REC TEMP LO	2	Err 179.02	Emergency shutdown	Can be cleared only on power cycle. After power cycle, the compressor shall resume normal operation.	Rectifier temperature greater than the shutdown threshold	High Load condition, heat sink performance loss (check thermal grease, cold plate torque) possible Drive hardware failure (Run Drive diagnostics) Call for tech support, record failure mode for warranty claim before replacing Drive.
		INV TEMP DER	3	N/A	Compressor speed Derated.	Ramp up to demand speed (normal operation).	Inverter temperature greater than the Derate threshold	High Load condition, heat sink performance loss (check thermal grease, cold plate torque)
		INV T EX DER	4	Err 179.04	Compressor speed Derated. This alert shall be an indication of an extended Derated performance.	Ramp up to demand speed (normal operation).	Inverter temperature greater than the Derate threshold and the system is being Derated for an extended period of time	High Load condition, heat sink performance loss (check thermal grease, cold plate torque) possible Drive hardware failure (Run Drive diagnostics)
		INV TEMP LO	5	Err 179.05	Emergency shutdown	Can be cleared only on power cycle. After power cycle, the compressor shall resume normal operation.	Inverter temperature greater than the shutdown threshold	High Load condition, heat sink performance loss (check thermal grease, cold plate torque) possible Drive hardware failure (Run Drive diagnostics) Call for tech support, record failure mode for warranty claim before replacing Drive.
180	Supply Voltage Failure	HI PWR DER	0	N/A	Compressor speed Derated.	Ramp up to demand speed (normal operation).	Low supply voltage and/or high power output from Drive-compressor running at a reduced RPM (Derate)	Maximum power is reduced with line voltage less than 200VAC. High load conditions, recirculation, dirty coils, low airflow
		LOW VOLT CO	2	Err 180.02	Emergency shutdown. Control will clear the fault and retry every 5 minutes.	Resume normal operation	Supply voltage is less than 175VAC	Supply voltage is less than 175VAC

Variable Speed Alert Codes

Alert Code	Alert Group	Display Assembly Text	Sub-alarm	A/TZONE 850/950	State action on occurrence	State action on clearance	Alert Description	Possible Cause
180	Supply Voltage Failure	HIGH PWR CO	3	"Wait"	Shutdown and retry after 5 minutes	Resume normal operation	Drive output current exceeds internal limit set for current sensor	High load condition. Overcharge, dirty coil (s), low airflow, recirculation, compressor failure, Drive hardware failure (Run Drive Diagnostics)
181	Gate Drive Failure	GATE DRV CO	0	Err 181.00	IGBT Failure. Gate driver fault is activated. Control will clear the fault and retry every 5 minutes.	Control will clear fault when condition no longer exists, 10 occurrences of gate drive failure cause the control to trip lock, which can only be cleared with a power cycle.	Drive hardware failure alert	Drive hardware failure. 10 consecutive occurrences will result in an Err 181.07
	Reverse Rotation Protection Soft Lockout	REV ROT CO	1	"Wait"	Soft Lockout for 5 minutes. Send "Wait" to Thermostat	After 5 minute time out, the compressor shall resume normal operation.	Suction Pressure has not changed at start up. Cannot execute start-up because suction pressure does not drop in the time allotted.	Compressor mis-wired, Suction Pressure Sensor Failure (verify accuracy) SOV bypassing, compressor not pumping
	Motor Phase Loss Detection	PHS LOSS CO	2	Err 181.02	Emergency shutdown. Control will clear the fault and retry every 5 minutes.	Resume normal operation. Control will clear fault when condition no longer exists.	Compressor cable connection or motor winding problem. (Verify wiring and windings)	Compressor cable connection or motor winding problem. (Verify wiring and windings) Run Drive Diagnostics to confirm failure mode.
	Reverse Rotation Protection Hard Lockout	REV ROT LO	3	Err 181.03	Can't start system without Service being called. Send error to thermostat and alert menu in CDA	Can be cleared only on power cycle.	Suction Pressure has not changed at start up. 5 Reverse Rotation Shutdowns have occurred	Compressor mis-wired, Suction Pressure Sensor Failure (verify accuracy) SOV bypassing, compressor not pumping
	Stall Detection	STALL DET CO	4	Err 181.04	Emergency shutdown. Locked Rotor. Control will clear the fault and retry every 5 minutes.	Resume normal operation. Control will clear fault when condition no longer exists.	Locked Rotor Condition has been detected	Locked Rotor Condition has been detected. Run Drive Diagnostics to confirm failure mode. Verify system is not grossly overcharged and that service valves are open. Replace compressor.
	Gate Drive Failure Trip Lock	GATE DRV LO	7	Err 181.07	10 consecutive occurrences of gate drive failure	Control needs to be power cycled.	10 consecutive occurrences of gate drive failure alert	Drive hardware failure. Run Drive Diagnostic Test to confirm failure mode. Call for tech support, record failure mode for warranty claim before replacing Drive.
	Illegal Configuration	CONFIG ERR	8	Err 181.08	Trip lock upon occurrence	Can only be cleared with a Power Cycle	Improper parameters used in Personality Module	Data in PM is corrupt or wrong PM installed.
	No Motor	NO MOTOR	9	Err 181.09	Shutdown. Send "clear alarm" message every 5 min and retry demand	Resume normal operation	The compressor motor is not detected (all three windings are not detected)	Compressor cable missing or not plugged in, all compressor windings shorted open.

Variable Speed Alert Codes

Alert Code	Alert Group	Display Assembly Text	Sub-alarm	A/TZONE 850/950	State action on occurrence	State action on clearance	Alert Description	Possible Cause
181	Initializa-tion Error	INIT ERR	10	Err 181.10	Emergency Shutdown. Control will clear the fault and retry every 5 minutes.	Resume normal operation. Control will clear fault when condition no longer exists.	Internal fault with micro and cannot initialize	Cycle power. If error continues call for tech support, record failure mode for warranty claim before replacing Drive.
	ADC Supply Range exceeded	ADC SUP EX	11	"Wait"	Emergency shutdown. Control will clear the fault and retry every 5 minutes.	Resume normal operation. Control will clear fault when condition no longer exists.	Internal communication fault	If error continues call for tech support, record failure mode for warranty claim before replacing Drive.
	ADC Inverter tempera-ture range exceeded	ADC INV T EX	12	"Wait"	Emergency shutdown. Control will clear the fault and retry every 5 minutes.	Resume normal operation. Control will clear fault when condition no longer exists.	Internal fault with temperature sensor.	If error continues call for tech support, record failure mode for warranty claim before replacing Drive.
	ADC Rectifier tempera-ture range exceeded	ADC REC T EX	13	"Wait"	Emergency shutdown. Control will clear the fault and retry every 5 minutes.	Resume normal operation. Control will clear fault when condition no longer exists.	Internal fault with temperature sensor.	If error continues call for tech support, record failure mode for warranty claim before replacing Drive.
	ADC reference range exceeded	ADC REF EX	14	"Wait"	Emergency shutdown. Control will clear the fault and retry every 5 minutes.	Resume normal operation. Control will clear fault when condition no longer exists.	Internal fault with micro	If error continues call for tech support, record failure mode for warranty claim before replacing Drive.
	ADC current range error	ADC CUR EX	15	"Wait"	Emergency shutdown. Control will clear the fault and retry every 5 minutes.	Resume normal operation. Control will clear fault when condition no longer exists.	Internal fault with current sensor	If error continues call for tech support, record failure mode for warranty claim before replacing Drive.
182	Startup Algorithm Fault	STRT SOFT LO	0	"Wait"	Can't execute start-up algorithm Can't start system for at least 5 minutes. Proceed to Normal shutdown. Send "Wait" to thermostat, send Alert to CDA home screen menu and history	Resume normal operation	Compressor has a failed startup attempt.	Drive is limiting compressor speed due to Inverter high temperature or high current.
		STRT HARD LO	1	Err 182.01	Shutdown. Can't start system without Service being called. Send error to thermostat and alert menu in CDA	Can be cleared only on power cycle. After power cycle, the compressor shall resume normal operation.	5 startup soft lockouts occurred without a successful start.	Drive is limiting compressor speed due to Inverter high temperature or high current.
183	Shutdown Algorithm Fault	SHTDWN CO	0	"Wait"	Control is reset internally. Retry after 5 minutes.	Resume normal operation after compressor comes to a halt.	Compressor does not come to a complete stop even after the defined time and continues to run even after control is released.	Loss of internal communication. If error continues after system resets, call for tech support.
184	Protection Algorithm Fault	IDCF CO	0	"Wait"	Shutdown. Soft lockout. Send "Wait" to thermostat, send Alert to CDA home screen menu and history	Resume normal operation after suction pressure is greater than 107psig (35°F saturated) and compressor cutout time has elapsed. Cut Out Time = 5 minutes	(In cooling mode) Indoor coil freeze protection is active. Suction pressure sensor is <78psig (20°F saturated) for 20 minutes.	Restricted airflow, low charge, low ambient operation, restriction in refrigerant system or metering device.

Variable Speed Alert Codes

Alert Code	Alert Group	Display Assembly Text	Sub-alar-m	A/TZONE 850/950	State action on occurrence	State action on clearance	Alert Description	Possible Cause
184	Protection Algorithm Fault	CDT HI SP CO	1	"Wait"	Shutdown. Dome temperature sensor value is 260°F or higher for at least 15 seconds with compressor speed greater than 2400 RPM. Soft lockout. Send "Wait" to thermostat, send Alert to CDA home screen menu and history	Resume normal operation after cutout time has elapsed. CO=15 minutes	Compressor High Temperature Protection at High Speed- Shutdown (Dome Temp Sensor).	High super heat at compressor - Low charge, restricted metering device, restricted condenser airflow in cooling mode, sensor accuracy, high indoor ambient in heat mode, (Indoor set point above 80°F) (Increase IDairflow)
		CDT LO SP CO	2	"Wait"	Shutdown. Dome temperature sensor value is 260°F or higher for at least 15 seconds with compressor speed less than 2400 RPM. Soft lockout. Send "Wait" to thermostat, send Alert to CDA home screen menu and history	Resume normal operation after compressor cutout time has elapsed. CO=15 minutes	Compressor High Temperature Protection at Low Speed-Shutdown (Dome Temp Sensor).	High super heat at compressor - Low charge, restricted metering device, restricted condenser airflow in cooling mode, sensor accuracy, high indoor ambient in heat mode, (Indoor set point above 80°F) (Increase IDairflow)
		LSPP CLG CO	3	"Wait"	Shutdown. Soft lockout. Send "Wait" to thermostat, send Alert to CDA home screen menu and history	Resume normal operation after compressor cutout time has elapsed. CO=5 minutes	Low Suction Pressure Protection in Cooling Mode. Less than 50 PSIG	Low charge, EEV pump down, restriction. Pressure transducer calibration.
		LSPP HTG CO	4	"Wait"	Shutdown. Soft lockout. Send "Wait" to thermostat, send Alert to CDA home screen menu and history	Resume normal operation after compressor cutout time has elapsed. CO=5 minutes	Low Suction Pressure Protection in Heating Mode. Less than 13 PSIG	Low charge, EEV pump down, restriction. Pressure transducer calibration. Extremely low outdoor ambient (ODT less than minus 10°F)
		MCLP CO	5	"Wait"	Shutdown. Soft lockout. Send "Wait" to thermostat, send Alert to CDA home screen menu and history	Resume normal operation after compressor cutout time has elapsed. CO=5 minutes	Maximum Current Low Speed Protection. High compressor load during low speed operation.	System operating under temperature extremes. Possible Derate condition, high compression ratio, damaged compressor (bearings/scroll set galled). Check for high dome temperature alert in previous history.
		DIAGCUR CO	6	"Wait"	Shutdown. Soft lockout. Send "Wait" to thermostat, send Alert to CDA home screen menu and history	Resume normal operation after compressor cutout time has elapsed. CO=5 minutes	In the compressor heating mode, current has exceeded allowable limit at the operating conditions.	At high speed operation (3600 RPM and above) Drive output current limit has been exceeded. Check for low indoor airflow, high system charge.
		MAX NORM LO	7	Err 184.07	Can't start system without Service being called. Send error to thermostat and alert menu in CDA	Can be cleared only on power cycle. After power cycle, the compressor shall resume normal operation.	Maximum number of protection shutdowns (Err 184.xx) have occurred.	Check previous history for 184.xx faults leading to lockout.
		HARD LOCKOUT	8	Err 184.08	Can't start system without Service being called. Send error to thermostat and alert menu in CDA	Can be cleared only on power cycle. Resume normal operation.	Universal Hard Lockout. Outdoor EEV will drive open.	Occurs anytime the system enters the Hard Lockout State. Investigate Alerts leading to this condition.

Variable Speed Alert Codes

Alert Code	Alert Group	Display Assembly Text	Sub-alarm	A/TZONE 850/950	State action on occurrence	State action on clearance	Alert Description	Possible Cause
184	Protection Algorithm Fault	INT LUBE FLT	9	"Wait"	Send error to thermostat and alert menu in CDA history	5 Minute compressor soft lockout time has elapsed	Internal Lubrication Failure. For 60 minutes internal lube does not occur and compressor RPM is below the limitation for internal lube to be satisfied.	A Derate condition exists that does not allow internal lube speed to be achieved when needed. Check for cause of Derate.
185	Protection Derating Fault	NO TEXT	0	N/A Only visible via Technician log in 950/850 history	Dome temperature is high. Limit compressor speed to prevent higher load.		Compressor Dome Temperature Protection, Limit compressor speed.	Low outdoor ambient heating condition.
		NO TEXT	1	N/A Only visible via Technician log in 950 history	Dome temperature is high. Decrease compressor speed to reduce load.		Compressor Dome Temperature Protection, Derate compressor speed.	Low outdoor ambient heating condition.
		NO TEXT	2	N/A Only visible via Technician log in 950 history	Dome temperature is high. Increase compressor speed to improve compressor cooling.		Compressor Dome Temperature Protection, Increase compressor speed.	Low speed heating with high indoor ambient.
		NO TEXT	3	N/A Only visible via Technician log in 950 history	Dome temperature is high. Limit compressor speed to prevent higher load.		Compressor Dome Temperature Protection, Limit compressor speed.	Low speed heating with high indoor ambient.
		CMPR LUBE	5	N/A			Compressor Lubrication cycle.	Low speed operation requires periodic lubrication cycle.
		NO TEXT	6	N/A Only visible via Technician log in 950/850 history	Low compressor speed with high Drive output current. Increase speed.		Low compressor speed with high Drive output current, Increase compressor speed.	Low speed with high condenser load. (Indoor coil in heating mode/outdoor coil in cooling mode)
		NO TEXT	7	N/A Only visible via Technician log in 950 history	Low compressor speed with high Drive output current. Hold speed.		Low compressor speed with high Drive output current, Limit compressor speed.	Low speed with high condenser load. (Indoor coil in heating mode/outdoor coil in cooling mode)
		CLG DERATE	8	N/A Only visible via Technician log in 950 history	Suction saturation temperature is 28 degrees For less (92 PSIG) for at least 20 minutes.	Saturated suction temperature is 35 degrees For higher (107 PSIG)	Indoor coil freeze protection is active, Derate compressor speed.	In cooling mode: low indoor/outdoor ambient operation. Low airflow, low humidity, Low RH dehumidification target.
		SYS OR	9	N/A			System Oil Return function active to bring oil back to compressor.	Low Dome temperature with an ON cycle and/or multiple short cycles.
		NO TEXT	10	N/A Only visible via Technician log in 950 history	Suction pressure is low		Low Suction Pressure Protection in cooling mode, Derate compressor speed.	In cooling mode: low indoor/outdoor ambient operation.

Variable Speed Alert Codes

Alert Code	Alert Group	Display Assembly Text	Sub-alar-m	A/TZONE 850/950	State action on occurrence	State action on clearance	Alert Description	Possible Cause
185	Protection Derating Fault	NO TEXT	11	N/A Only visible via Technician log in 950/850 history	Suction pressure is low		Low Suction Pressure Protection in cooling mode, Limit compressor speed.	In cooling mode: low indoor/outdoor ambient operation.
		NO TEXT	12	N/A Only visible via Technician log in 950 history	Suction pressure is low		Low Suction Pressure Protection in heating mode, Derate compressor speed.	In heating mode: low outdoor ambient/ indoor temperature operation.
		NO TEXT	13	N/A Only visible via Technician log in 950 history	Suction pressure is low		Low Suction Pressure Protection in heating mode, Limit compressor speed.	In heating mode: low outdoor ambient/ indoor temperature operation.
		NO TEXT	14	N/A Only visible via Technician log in 950 history	Drive output current is high		High compressor speed with high Drive output current, Derate compressor speed.	In heating mode, high indoor coil load or high outdoor ambient.
		NO TEXT	15	N/A Only visible via Technician log in 950 history	Drive output current is high		High compressor speed with high Drive output current, Limit compressor speed.	In heating mode, high indoor coil load or high outdoor ambient.
186	MOC Protection Derating Fault	NO TEXT	0	N/A	Drive output current is high		High Drive output current, Limit compressor speed.	High compressor load
		NO TEXT	1	N/A	Drive output current is high		High Drive output current, Derate compressor speed.	High compressor load
		NO TEXT	2	N/A	Drive Inverter temperature is high		High Inverter temperature, Limit compressor speed.	High compressor load
		NO TEXT	3	N/A	Drive Inverter temperature is high		High Inverter temperature, Derate compressor speed.	High compressor load
		NO TEXT	4	N/A	Drive Rectifier temperature is high		High Rectifier temperature, Limit compressor speed.	High compressor load
		NO TEXT	5	N/A	Drive Rectifier temperature is high		High Rectifier temperature, Derate compressor speed.	High compressor load
187	Evacuation Mode	EVACUATION	0	Err 187.00	Outdoor unit operation shall not be allowed. EEV drives to full open.	Resume normal operation after Power Cycle	Evacuation mode has been executed from the CDA. ODU operation is locked out and EEV drives to full open.	Evacuation mode has been executed from the CDA.

Variable Speed Alert Codes

Alert Code	Alert Group	Display Assembly Text	Sub-alarm	A/TZONE 850/950	State action on occurrence	State action on clearance	Alert Description	Possible Cause
187	Drive Diagnostics Mode	DRV TEST	1	Err 187.01	Drive diagnostic test has been executed - send alert message to thermostat and CDA.	Exit the drive test at the CDA, after 120 minute time out or by power cycling the unit.	Drive Diagnostics Test is in progress	Technician to determine after running the diagnostic test. See CDA Technicians Control menu. This information will be required for warranty replacement part credit.
188	Storage Load Failure	STR LOAD F	0	Err 188.00	Shutdown	Cycle Power to clear hard lockout condition	Internal Error	Cycle Power. If error does not clear, call for tech support, record failure mode for warranty claim before replacing Drive.
	Storage Update Failure	STR UPD F	1	Err 188.01	Shutdown	Cycle Power to clear hard lockout condition	Internal Error	Cycle Power. If error does not clear, call for tech support, record failure mode for warranty claim before replacing Drive.
	State Failure	STATE ERR	2	Err 188.02	Shutdown	Cycle Power to clear hard lockout condition	Internal Error	Cycle Power. If error does not clear, call for tech support, record failure mode for warranty claim before replacing Drive.
	Hardware Variant Read Failure	HW VAR RD F	3	Err 188.03	Shutdown	Cycle Power to clear hard lockout condition	Internal Error	Cycle Power. If error does not clear, call for tech support, record failure mode for warranty claim before replacing Drive.
	Application Exception	APP EXCP	4	Err 188.04	Shutdown	Cycle Power to clear hard lockout condition	Internal Error	Cycle Power. If error does not clear, call for tech support, record failure mode for warranty claim before replacing Drive.
	No Configuration	NO CONFIG	5	Err 188.05	Shutdown	Cycle Power to clear hard lockout condition	Internal Error	Verify that PM is installed and matches the model number and serial number of unit. Cycle Power. If error does not clear, call for tech support, record failure mode for warranty claim before replacing Drive.
	Bad Configuration	BAD CONFIG	6	Err 188.06	Shutdown	Cycle Power to clear hard lockout condition	Internal Error	Verify that PM is installed and matches the model number and serial number of unit. Cycle Power. If error does not clear, call for tech support, record failure mode for warranty claim before replacing Drive.
	Voltage VPOS Low	VPOS LOW	7	Err 188.07	Shutdown	Cycle Power to clear hard lockout condition	Internal Error	Cycle Power. If error does not clear, call for tech support, record failure mode for warranty claim before replacing Drive.

Variable Speed Alert Codes

Alert Code	Alert Group	Display Assembly Text	Sub-alarm	A/TZONE 850/950	State action on occurrence	State action on clearance	Alert Description	Possible Cause
188	Voltage VPOS High	VPOS HIGH	8	Err 188.08	Shutdown	Cycle Power to clear hard lockout condition	Internal Error	Cycle Power. If error does not clear, call for tech support, record failure mode for warranty claim before replacing Drive.
	Voltage VCC Low	VCC LOW	9	Err 188.09	Shutdown	Cycle Power to clear hard lockout condition	Internal Error	Cycle Power. If error does not clear, call for tech support, record failure mode for warranty claim before replacing Drive.
	Voltage VCC High	VCC HIGH	10	Err 188.10	Shutdown	Cycle Power to clear hard lockout condition	Internal Error	Cycle Power. If error does not clear, call for tech support, record failure mode for warranty claim before replacing Drive.
189	Control Board Temperature High	BRD TEMP DER	0	N/A	Compressor speed Derated	Control must clear the flag when this condition no longer exists.	Compressor Actual speed not equal to compressor requested speed Limit compressor RPM.	High ambient conditions, recirculation discharge air, blocked coil, sensor calibration.
		BRD TEMP CO	1	"Wait"	Shutdown and retry after 5 minutes	Resume normal operation	Control board temperature is high. Shutdown and retry after 5 minutes.	High ambient conditions, recirculation discharge air, blocked coil, sensor calibration.
Local	Unit Bus Fault1	UNIT BUS FLT 1 CDA COM ERR	0	N/A	IPC3 communication link is not active or the Node ID is not configured No bus manager or IPC3 bus time out	CDA is configured OR OD starts communicating on IPC3	No information to or from technician interface. Test modes, monitor, alerts and config menus lost.	Loss of communication between IVSC and CDA. Check wire harness and connections between IVSC plug J2 and CDA.
Local	Unit Bus Fault2	UNIT BUS FLT 2 CDA COM BUSY	1	N/A	The content provider is not responding, i.e. no acknowledgement message from content provider even after retries	CDA starts responding.	No information to or from technician interface. Test modes, monitor, alerts and config menus lost.	IVSC or CDA could be at fault. When system operates as expected, the CDA has most likely failed.
Local	Keypad Error	CDA will stay on same screen till timeout and then jump to default screen	2	N/A	A key/keys are continuously pressed for more than one minute	Key/keys are released	A key/keys are continuously pressed for more than one minute.	Key(s) were held down for too long or there is a stuck key.

Refrigeration Circuits for Heating and Cooling

Figure 11. 2 Ton HP (024 Models)

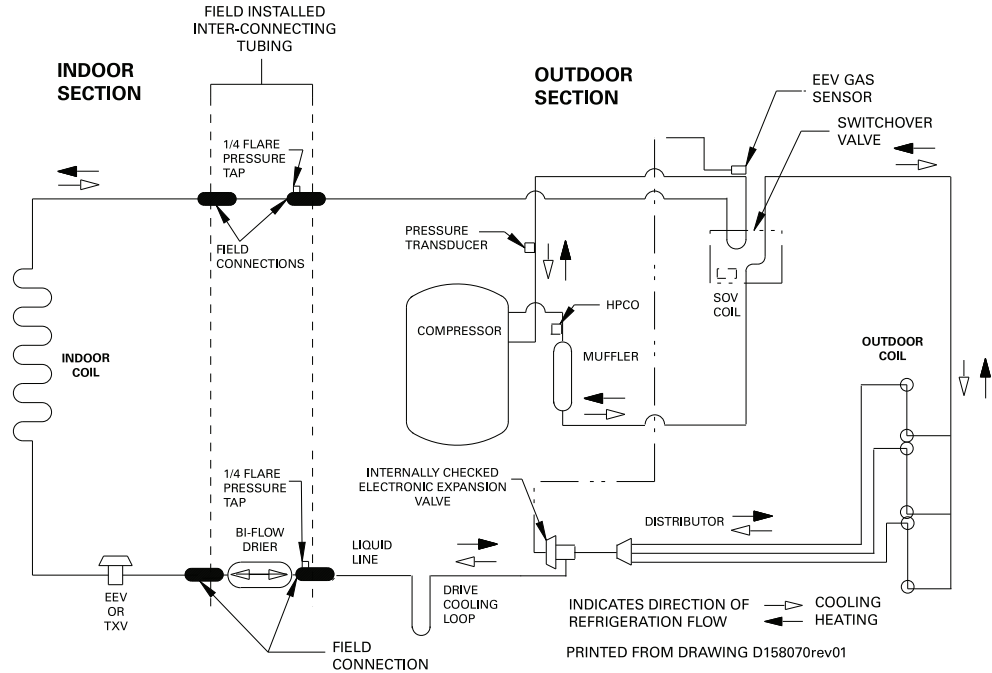
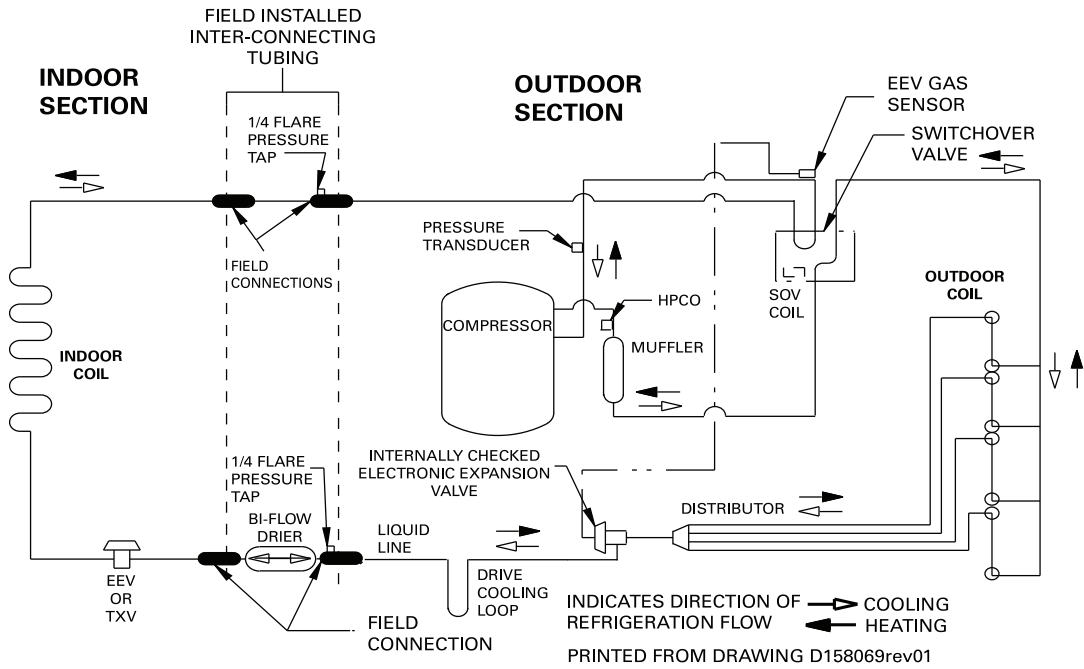

Figure 12. 3 Ton HP (036 and 37 Models)



Refrigeration Circuits for Heating and Cooling

Figure 13. 4 Ton HP (048 Models)

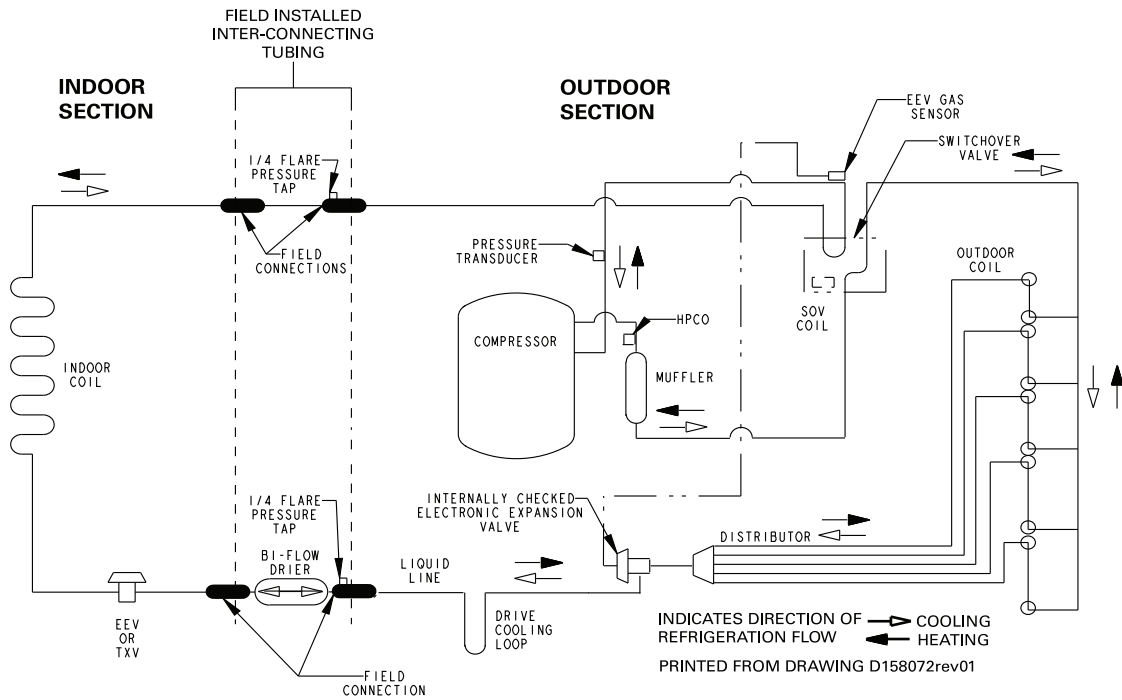
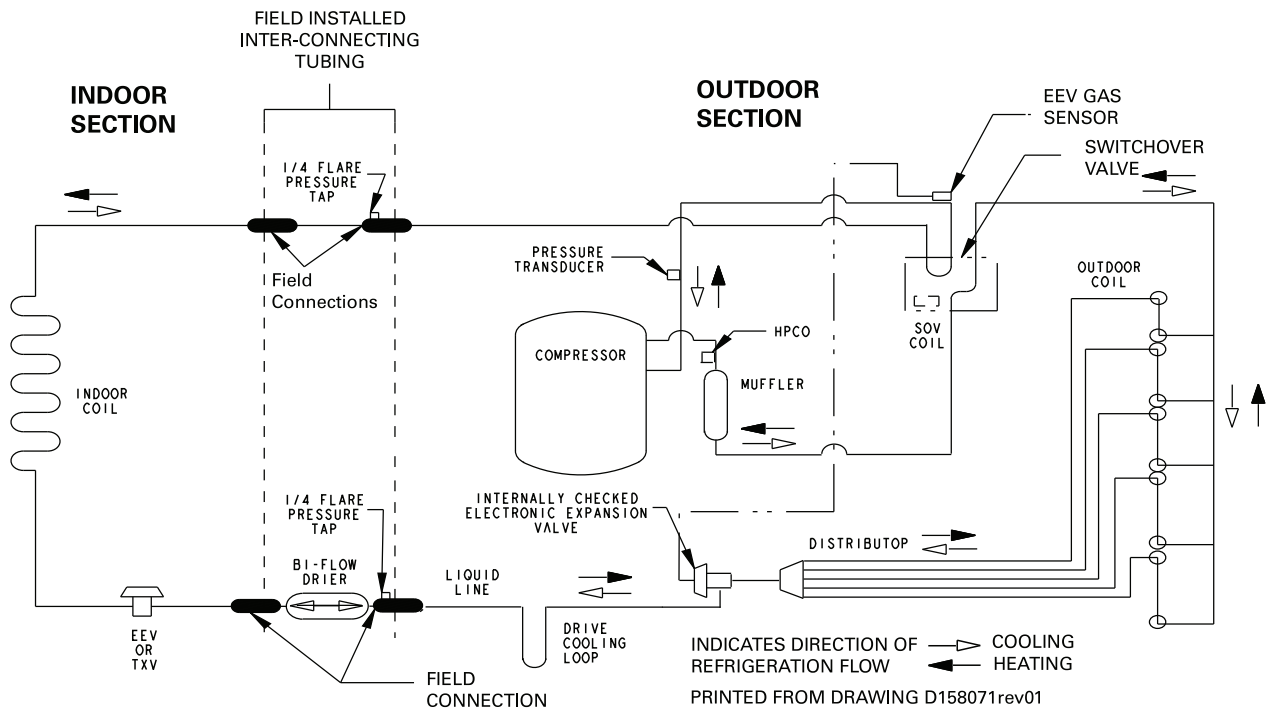

Figure 14. 4 Ton HP (049 Models)



Refrigeration Circuits for Heating and Cooling

Figure 15. 5 Ton HP (060 Models)

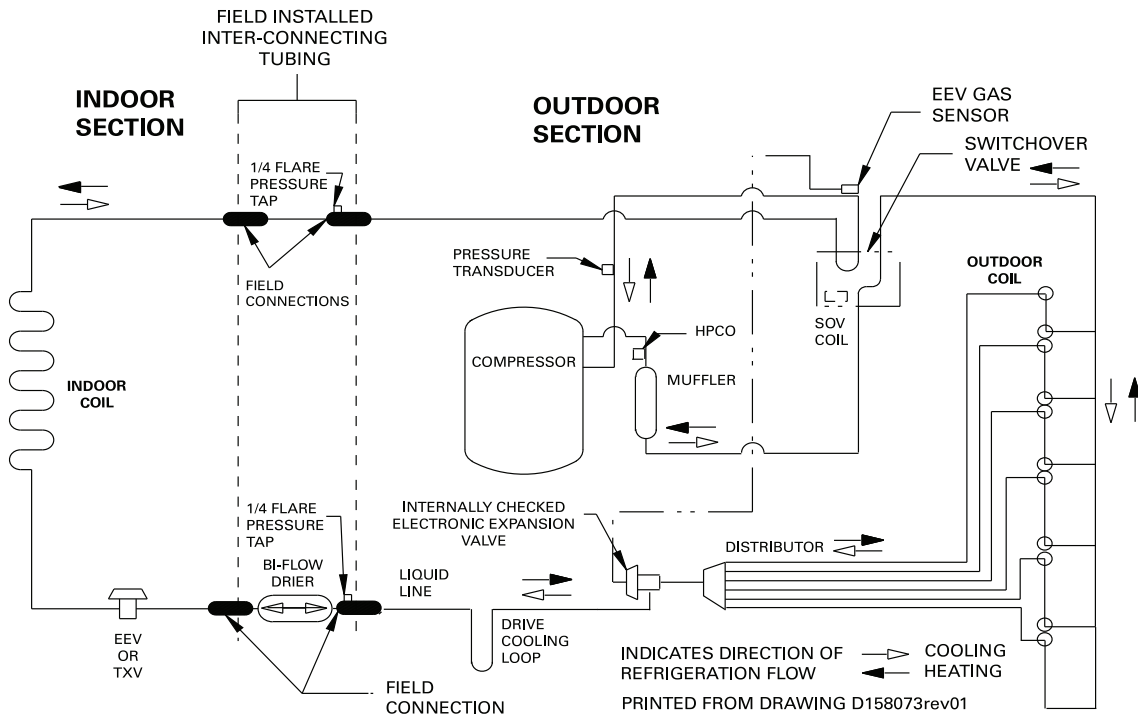
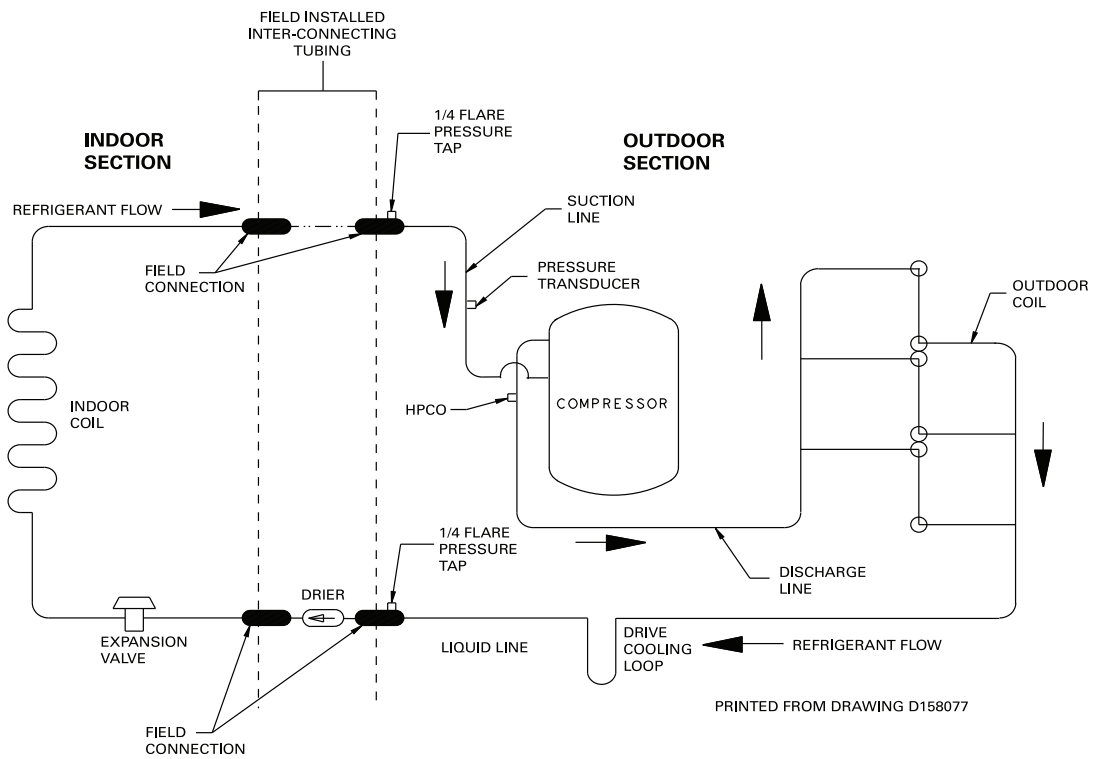

Figure 16. 2 TON A/C (024 Models)



Refrigeration Circuits for Heating and Cooling

Figure 17. 3 Ton A/C (036 and 037 Models)

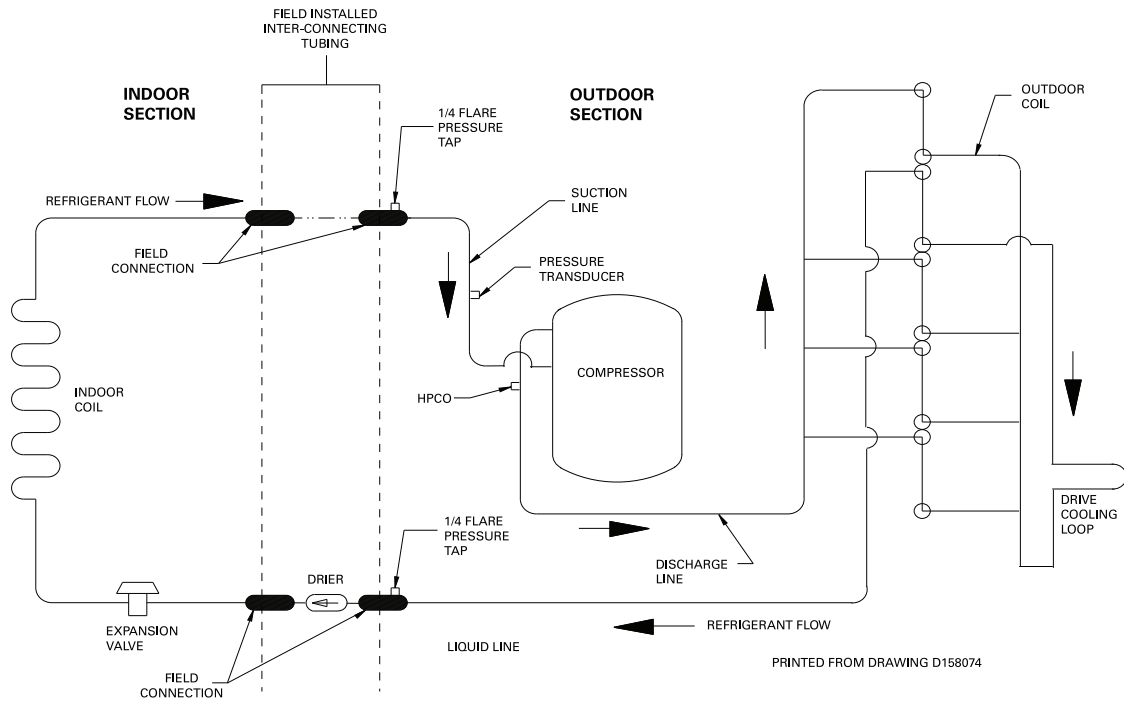
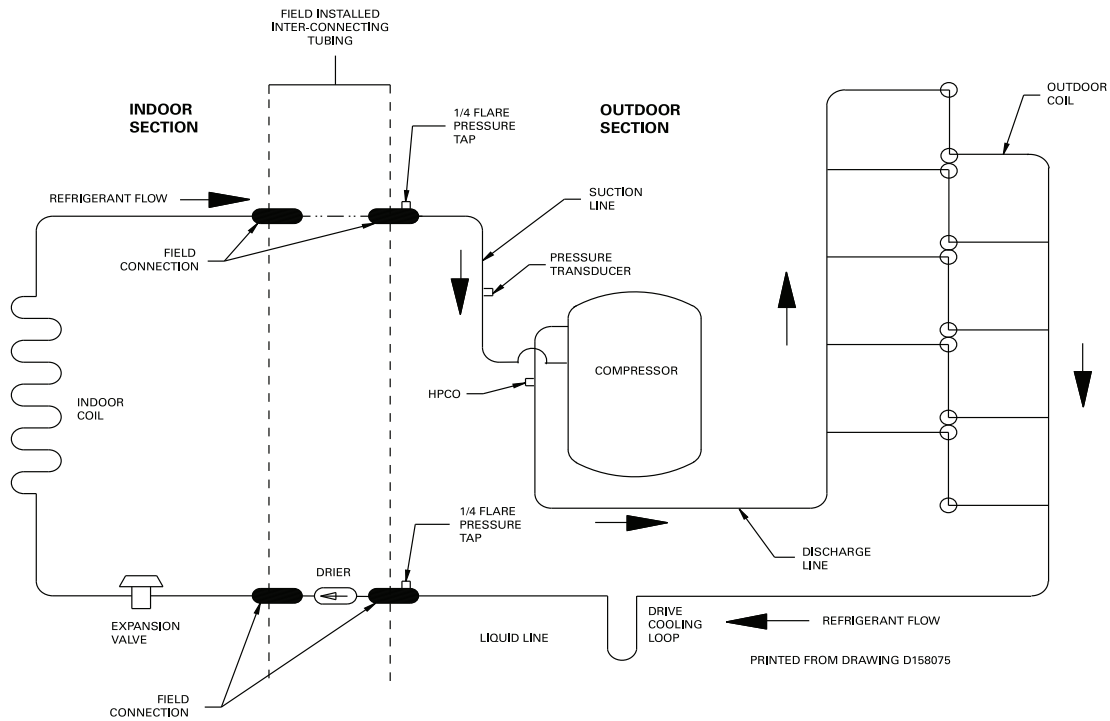
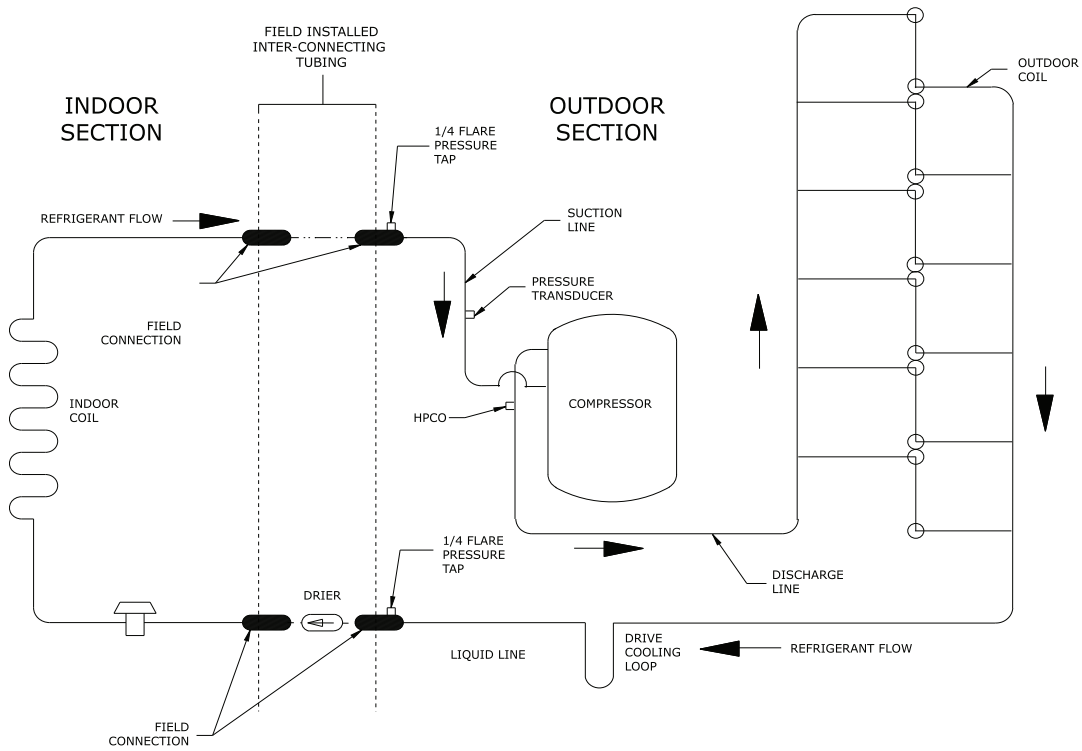

Figure 18. 4 Ton A/C (048 Models)



Refrigeration Circuits for Heating and Cooling

Figure 19. 5 Ton A/C (060 Models)



Load Shedding

External Shutdown

External Shutdown is used for Load Shedding and applies to both heating and cooling modes of operation.

When applied, External Shutdown will allow for an operation to be interrupted when triggered by an external control device. Typical examples of external control devices are smart-home, home automation services, utility load shed/grid management, event/time of day pricing entities. While communicating devices and methodology of application are the responsibility of the provider, connection points with explanations of internal logic and trigger requirements are provided in this Technical Manual.

Enabling External Shutdown is accomplished at the Outdoor Unit via the Communicating Display Assembly (CDA) Technician Configuration Menu along with field supplied wiring and ¼ stake-on hardware connections at the T3 & T4 LOAD SHED terminals. CDA options available are INACTIVE where the External Switch input is ignored and compressor operation is always enabled where the External Switch input is ACTIVE-SENSED.

Open contacts will disable compressor operation and closed contacts will enable compressor operation. The Factory Default configuration is INACTIVE.

Upon enabling this feature, the 950/850 will provide notification when this feature is ACTIVE. The installer will need to apply 24VAC to the R pigtail, then route the 24VAC from the Load Shed terminal T3 to a set of Normally Closed (N.C.) contacts and back to Load Shed terminal T4 for normal, uninterrupted compressor operation. When the externally applied contacts change position to Open, the outdoor control interprets this as Demand Response or Load Shed and sends a message to the 950/850 to disable compressor operation. The ODU will not be allowed to operate until contacts close and 24VAC is again sensed at the ODU Load Shed contact T4. If the unit is already running and the external contacts open, the ODU will begin a shutdown routine and operations will be interrupted for as long as the contacts remain open. When Load Shed is active (open contacts), the 950/850 will provide a text display of Load Shed Active.

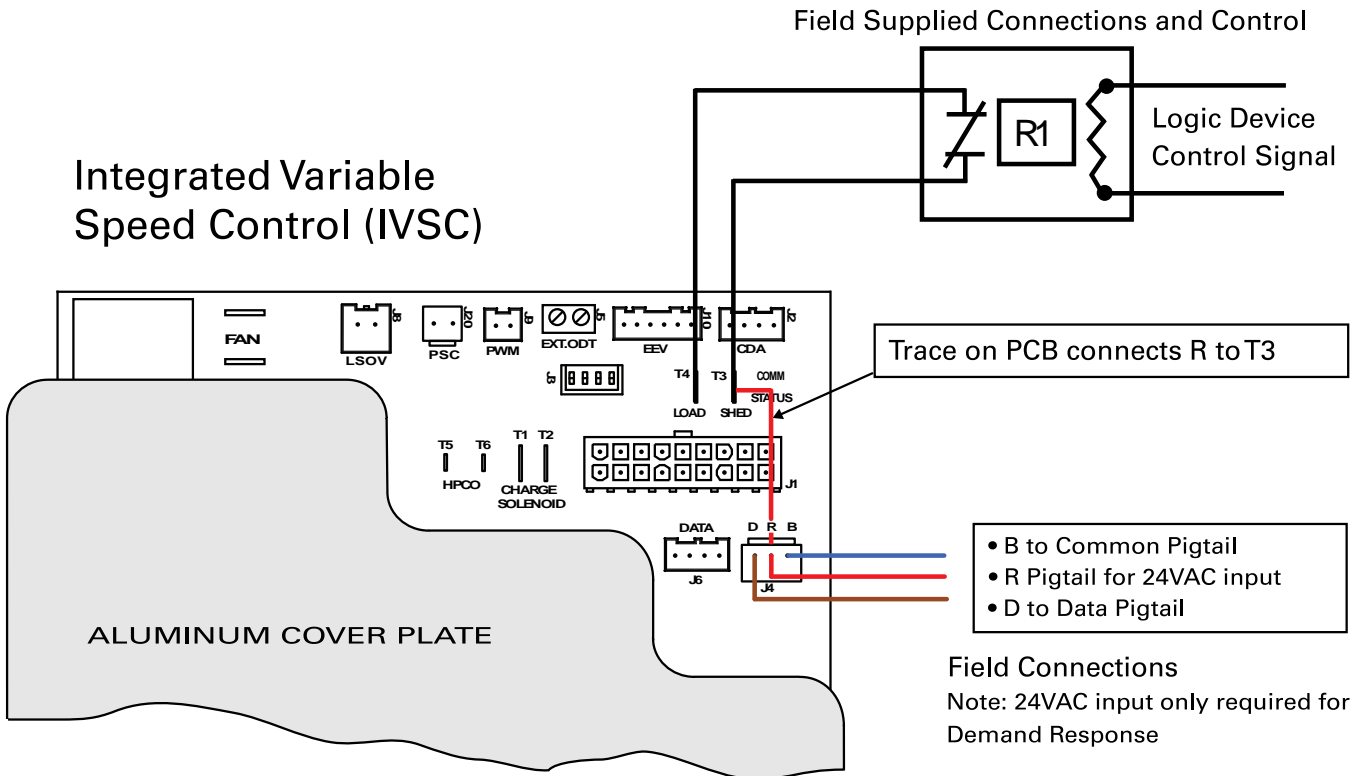

Note: See Communication Display Assembly (CDA) instructions for External Switch found in the Configuration Menu.

Communication Loss

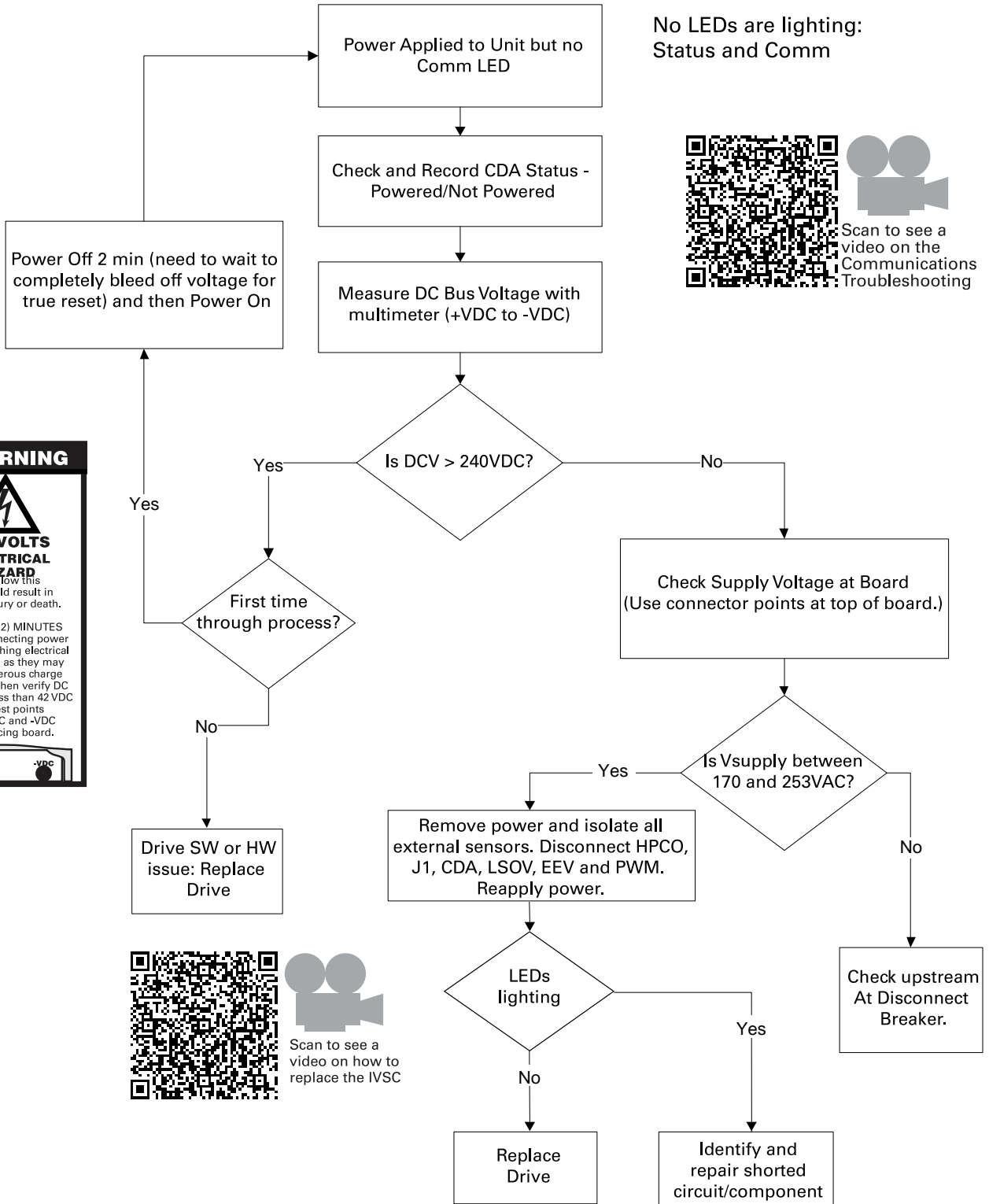

No LEDs are lighting:
Status and Comm



WARNING

400 VOLTS ELECTRICAL HAZARD

Failure to follow this warning could result in personal injury or death.

WAIT TWO (2) MINUTES after disconnecting power prior to touching electrical components as they may hold a dangerous charge of 400VDC, then verify DC Voltage is less than 42 VDC at inverter test points labeled +VDC and -VDC before servicing board.



Breaker Trip Procedure

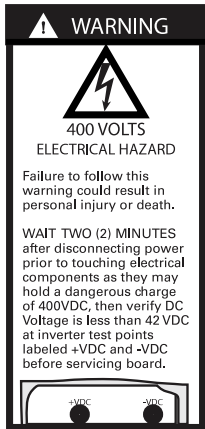

Breaker Trip Procedure

- Verify wiring
- Verify sensor readings
- Check breaker
- Check breaker size
- Check for GFCI on circuit
- Replace breaker if necessary



Scan to see a video on the Breaker Trip Procedure

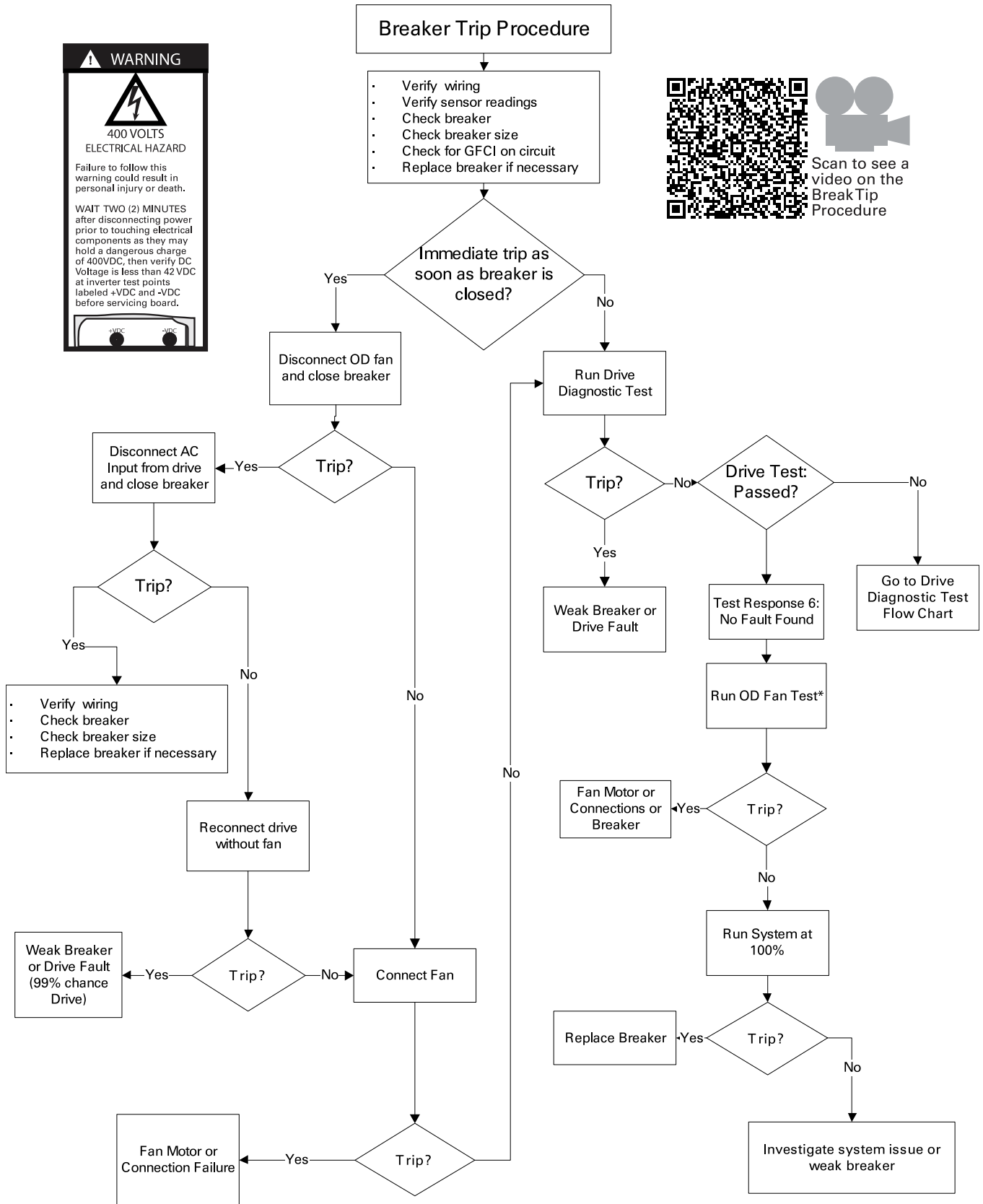

Start Compressor

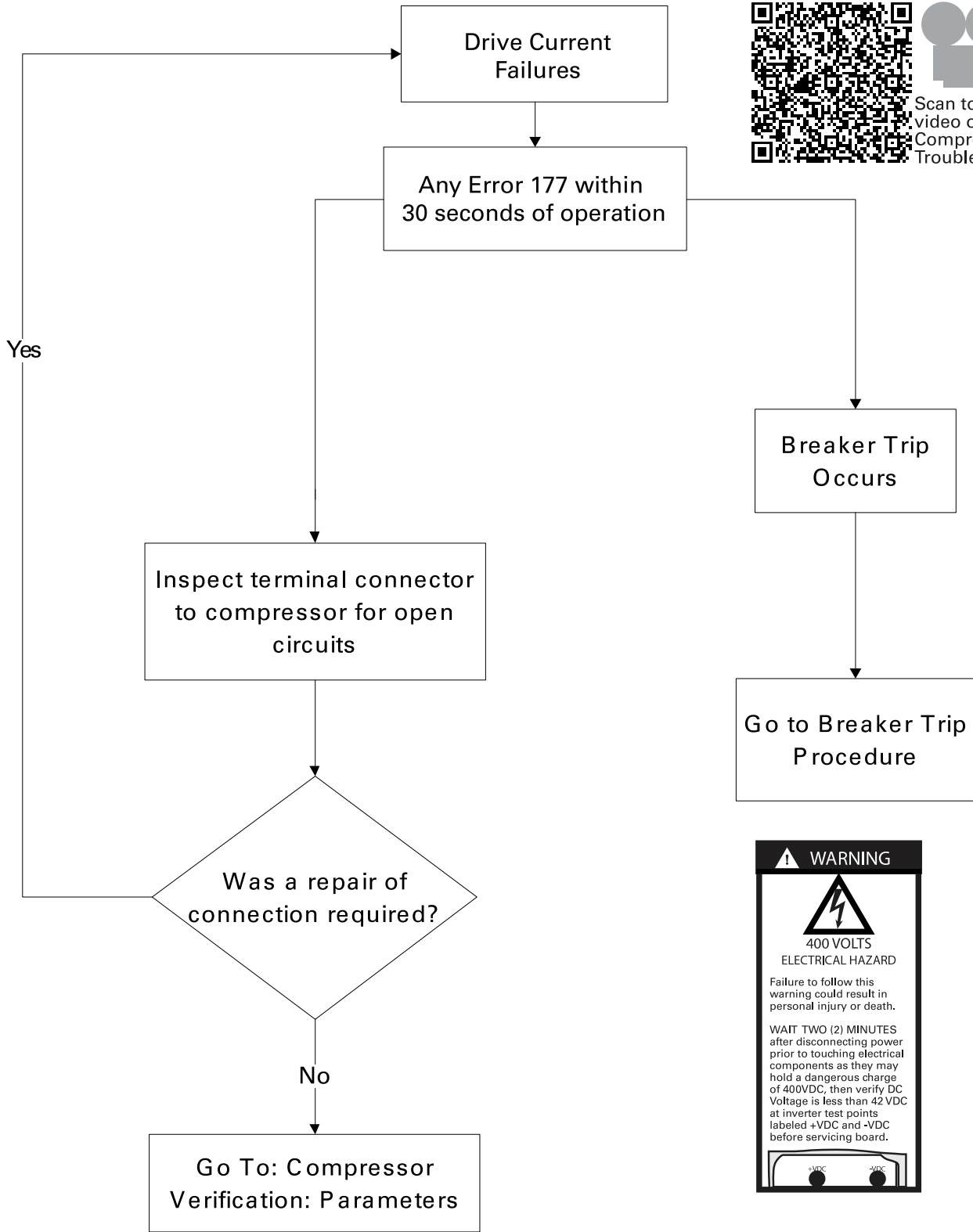

Scan to see a video on the Compressor Troubleshooting

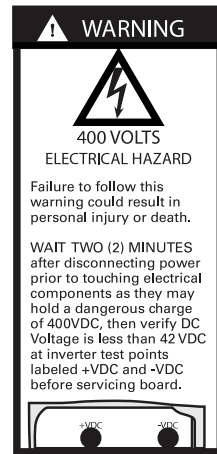

Compressor Verification: Parameters

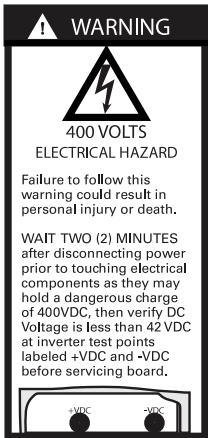
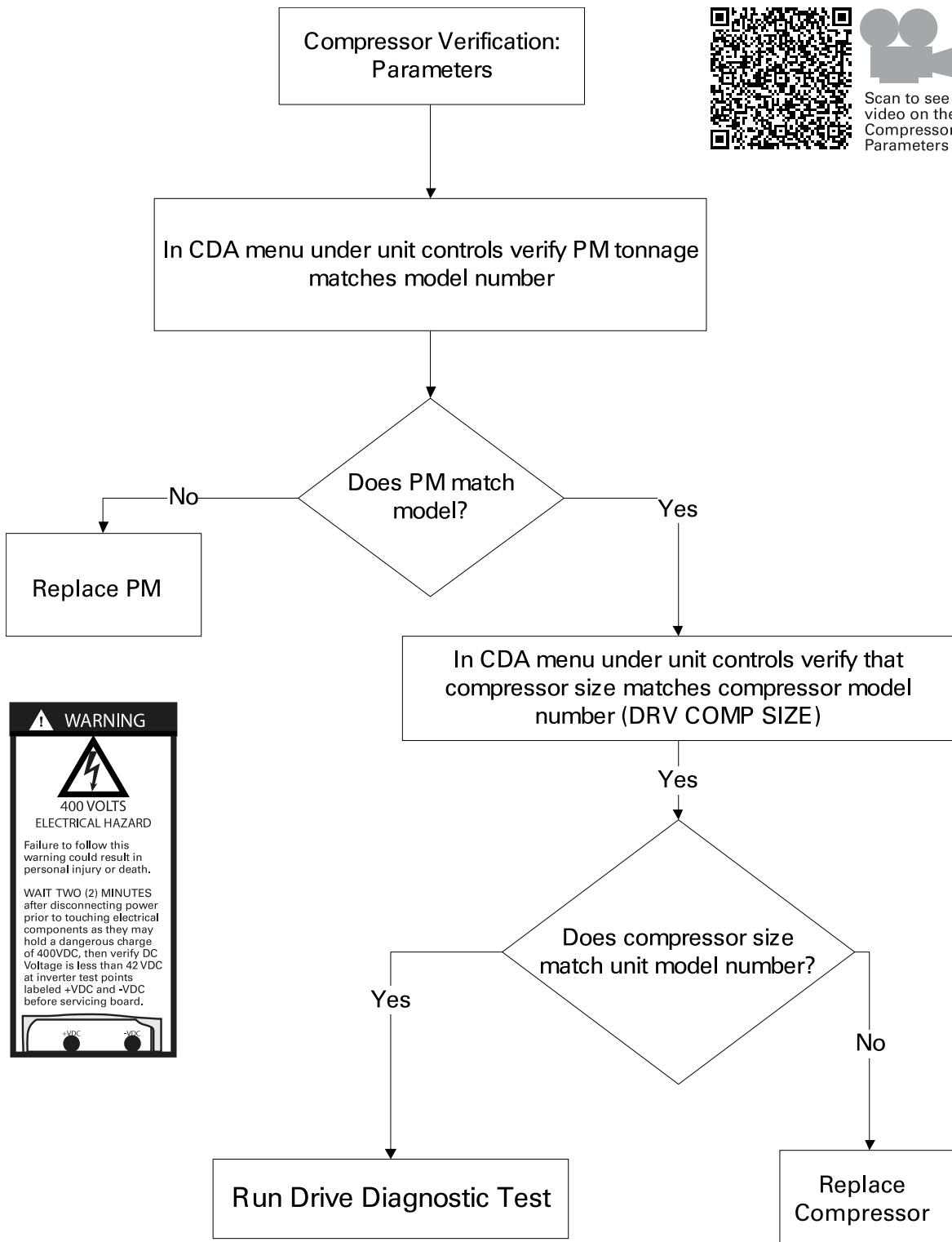

Run Drive Diagnostic Test

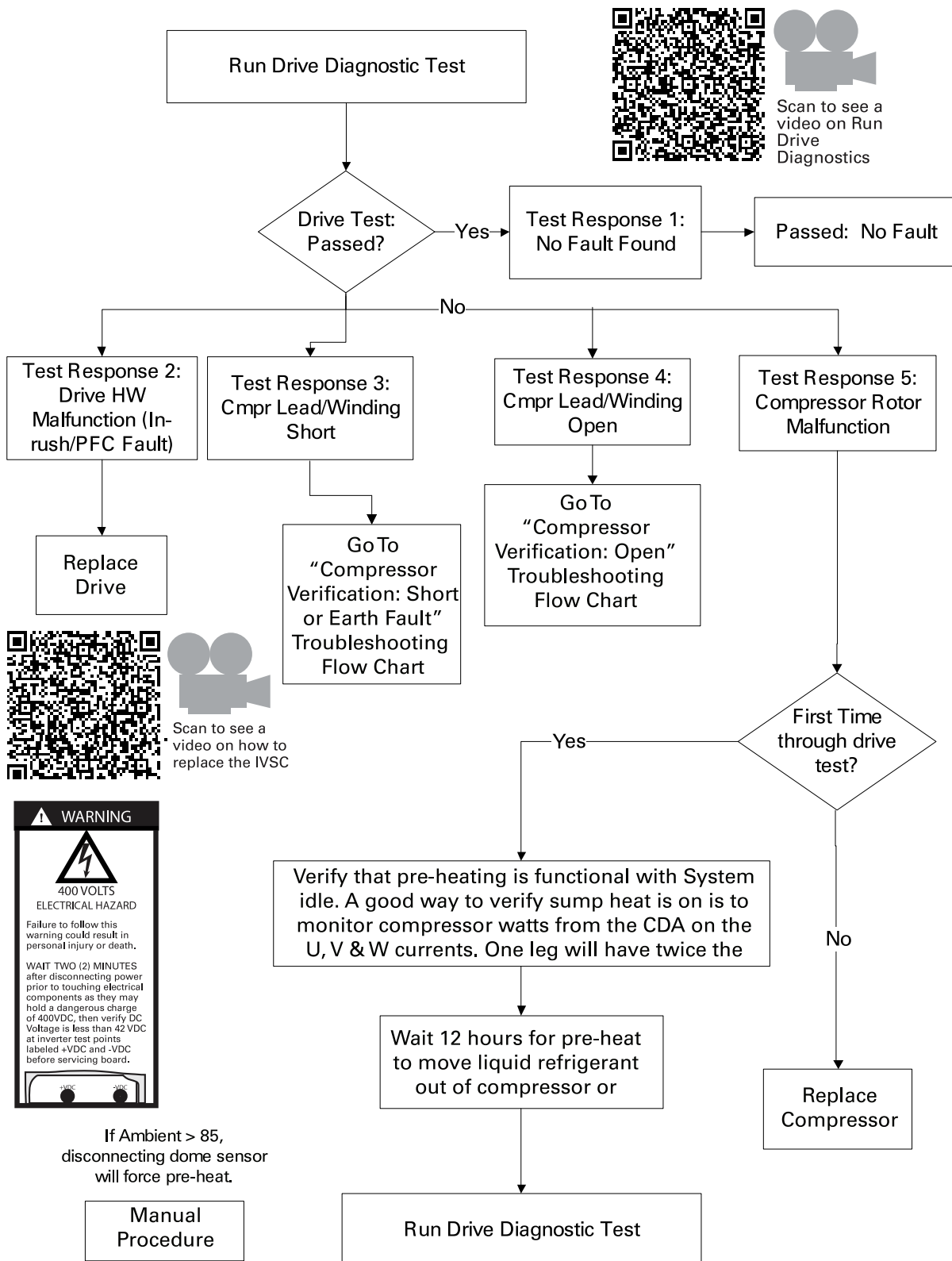

Compressor Verification: Short

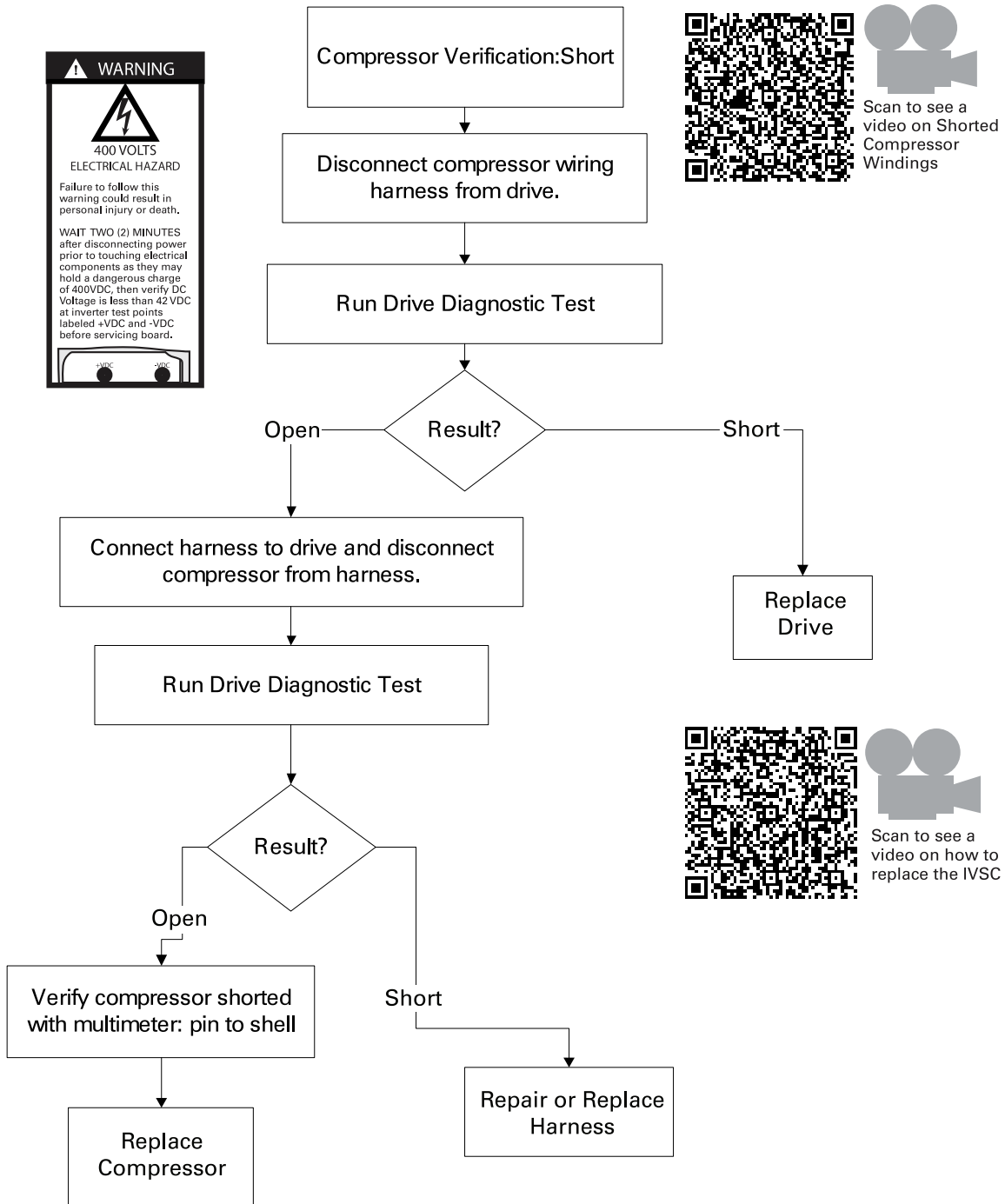
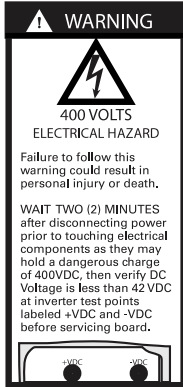

Compressor Verification: Open

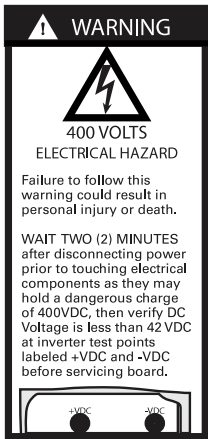

Compressor Verification:
Open



Scan to see a video on Open Compressor Windings

Disconnect compressor wire harness from drive and manually check resistance leg-to-leg

For reference: resistance should be 0.4-0.5 Ohms

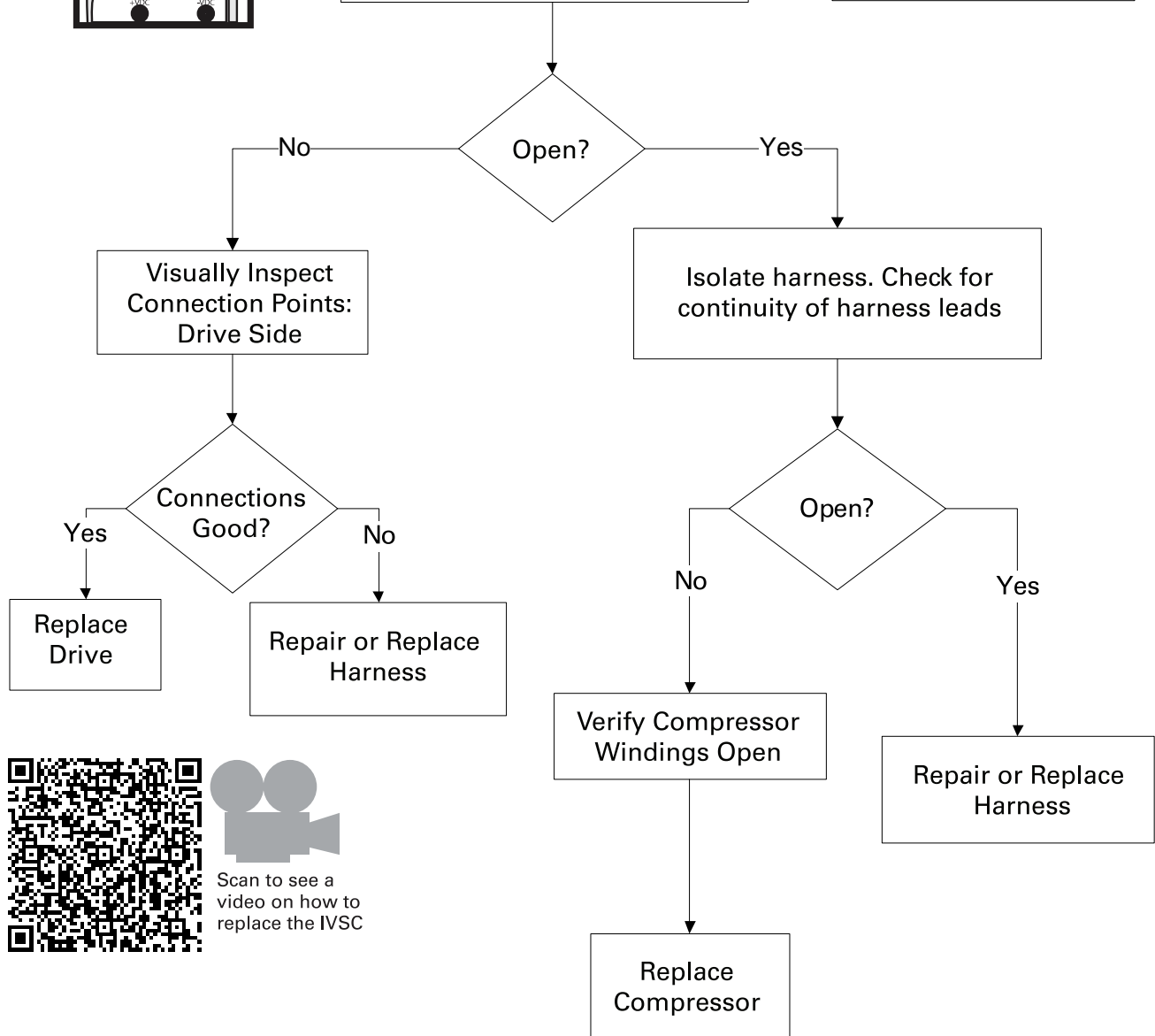

Scan to see a video on how to replace the IVSC

Inverter Temperature

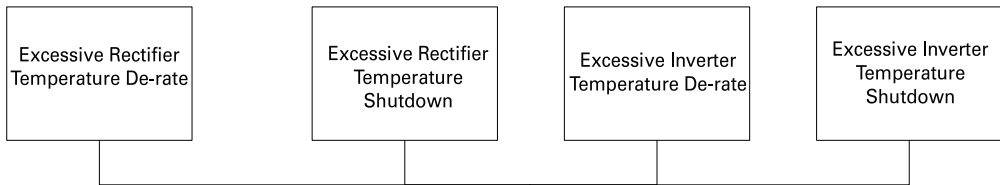

Scan to see a video on Inverter Temperature Troubleshooting

Check system condition: outdoor temp sensor, suction temp, suction pressure inverter temp, rectifier temp, dome temp and drive current for each leg, supply voltage

Is System in normal operating state?
Verify operating range is within limits. See product specifications for more information.

Check for System Issue

Lack of Heat Dissipation
Due to:
OD fan failure in cooling
ID fan failure in heating
Ref. blockage
Charge
Non-condensibles

Visual/Mechanical Inspection of Heat Sink OK?
Are all fasteners present
Alignment of bracket
Cracks in bracket
Corrosion/pitting

Verify Module Temperature Sensors:
1) Shutdown unit and wait at least 30 minutes
2) Inverter and rectifier temperature sensors should both be close to the ambient temperature. Use CDA Monitor Menu.

Do Inverter/Rectifier temps look in range?

Disassemble Tube from cold plate
Check Torque of screws (40-50 in. lbs.). Tighten mounting screws and/or re-do thermal paste

Cooling Issue: Drive Failure or still ambient condition issue

Sensor Fault
Drive Failure

Proceed to Startup and check inverter and rectifier temperatures (normal range is less than 200F)

WARNING

**400 VOLTS
ELECTRICAL HAZARD**

Failure to follow this warning could result in personal injury or death.

WAIT TWO (2) MINUTES after disconnecting power prior to touching electrical components as they may hold a dangerous charge of 400VDC, then verify DC Voltage is less than 42 VDC at inverter test points labeled +VDC and -VDC before servicing board.

Electronic Expansion Valve (EEV) Troubleshooting Flowchart

The Electronic Expansion Valve (EEV) installed in this heat pump is designed to control superheat entering the compressor when the system is running in mechanical heating mode. During cooling mode, refrigerant flow is controlled by the expansion device in the indoor unit. Therefore, any operational problems observed in cooling mode are not caused by the outdoor EEV.

The following flow chart was designed to assist in troubleshooting the EEV.

Note: The EEV closes with every OFF cycle in the heating mode of operation. During Defrost and in the Cooling mode of operation, the EEV will drive to full open.

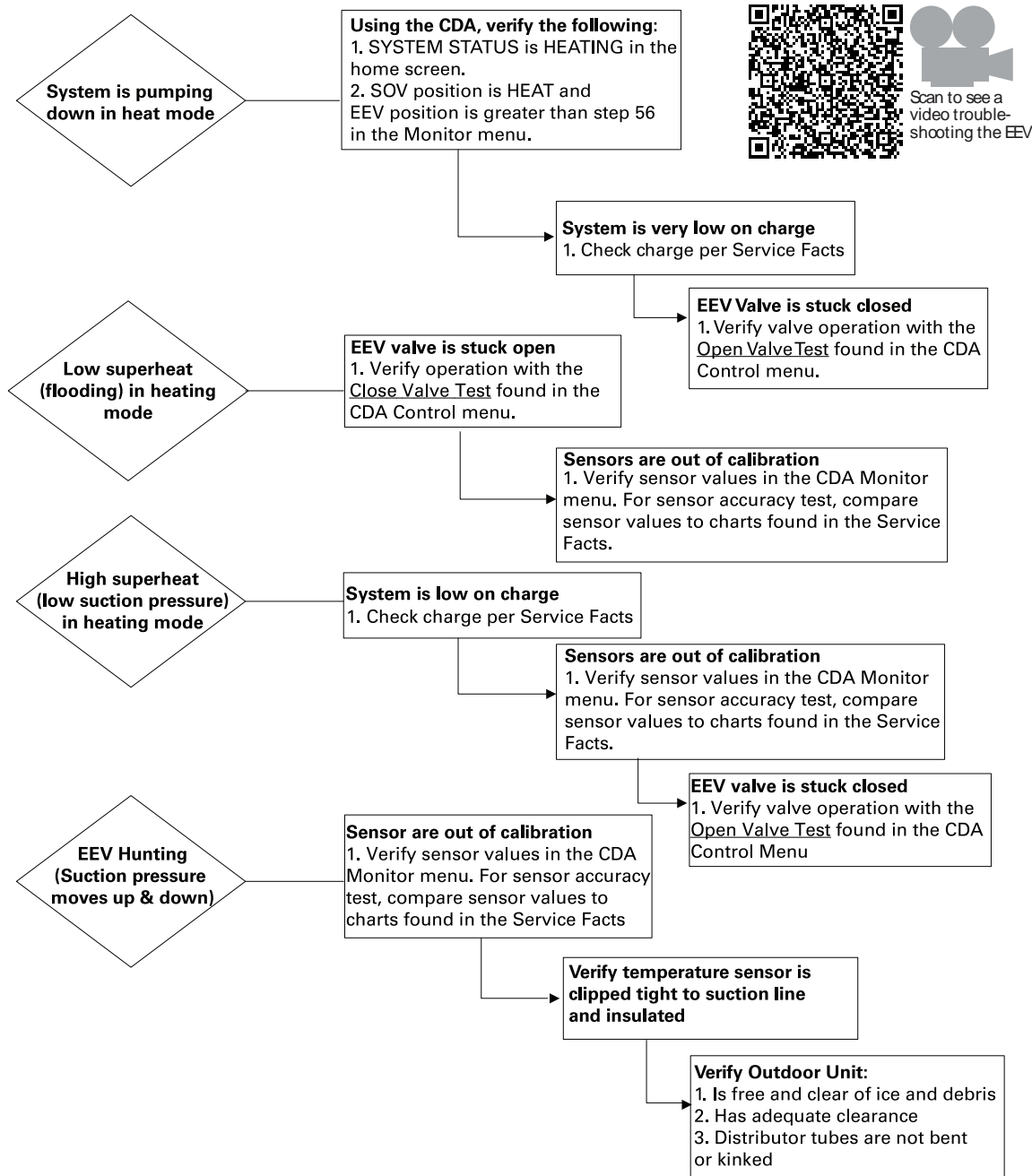

Communicating Display Assembly

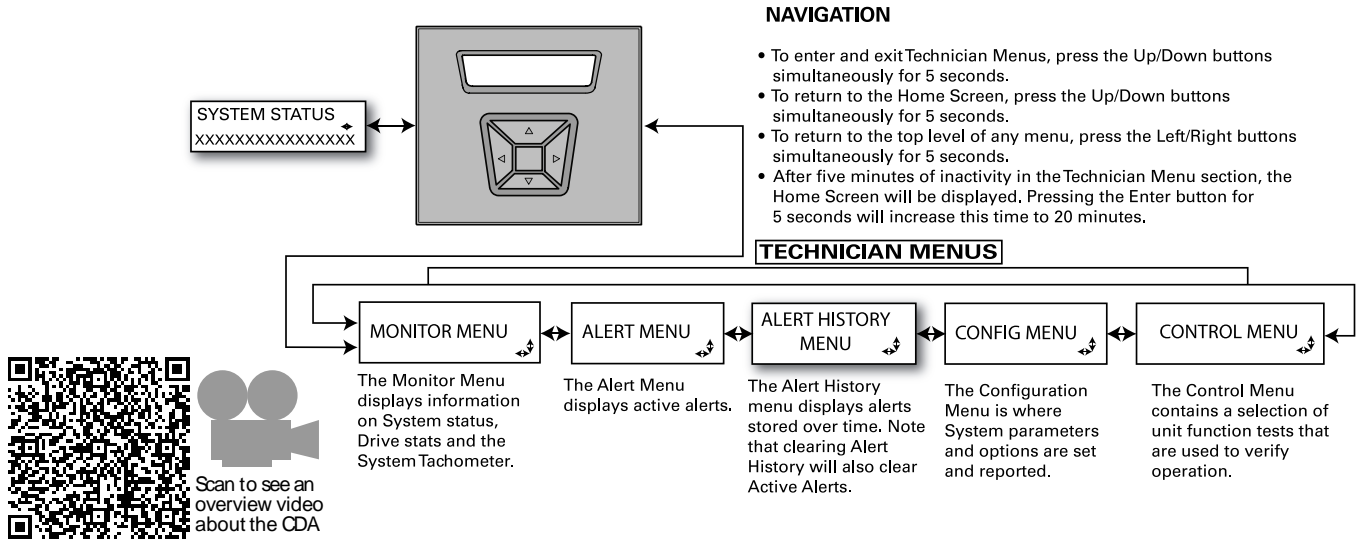

Home Screen – Communicating Display Assembly

Table 6. Status Menu/Home Screen

- The System Status is shown continuously on the Home Screen.
- The System Status will alternate with Fault Information if there is an active fault.
- Low level faults do not appear on the Home Screen.

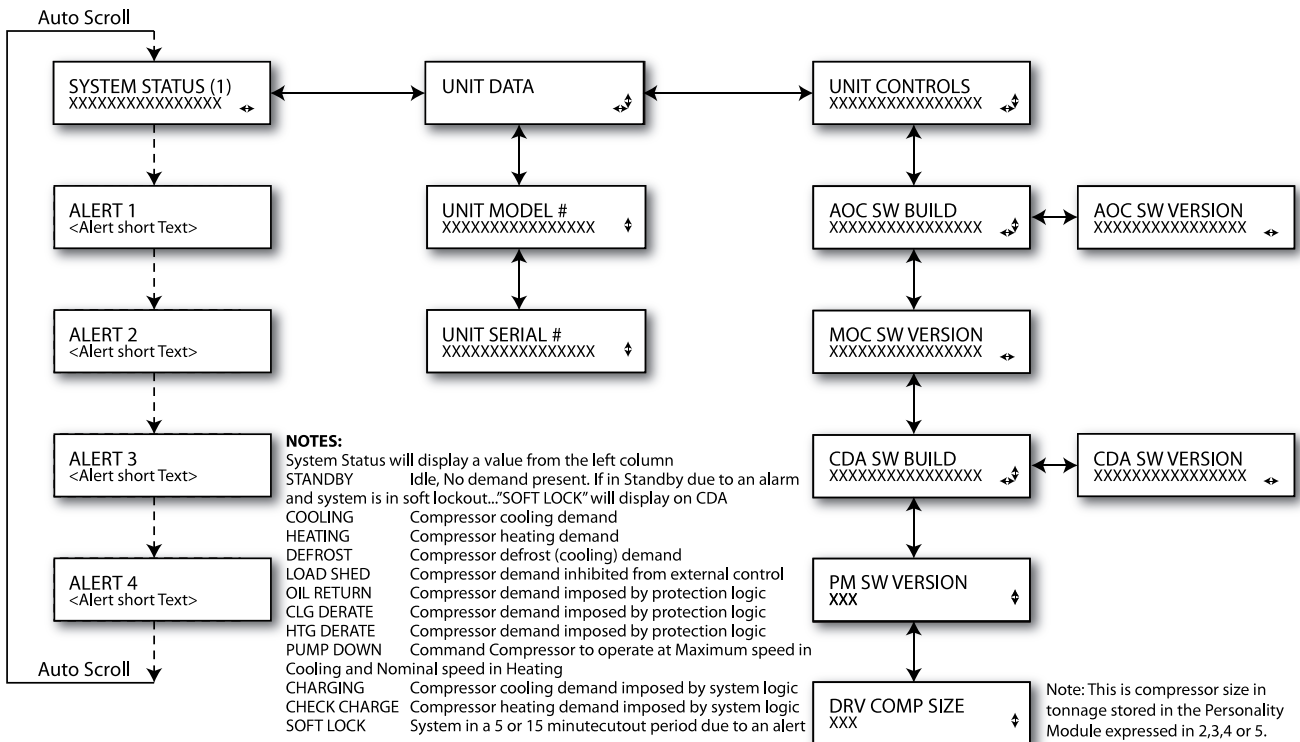

Technician Monitor Menu

The Monitor Menu displays information on System status, Drive stats and the System Tachometer.

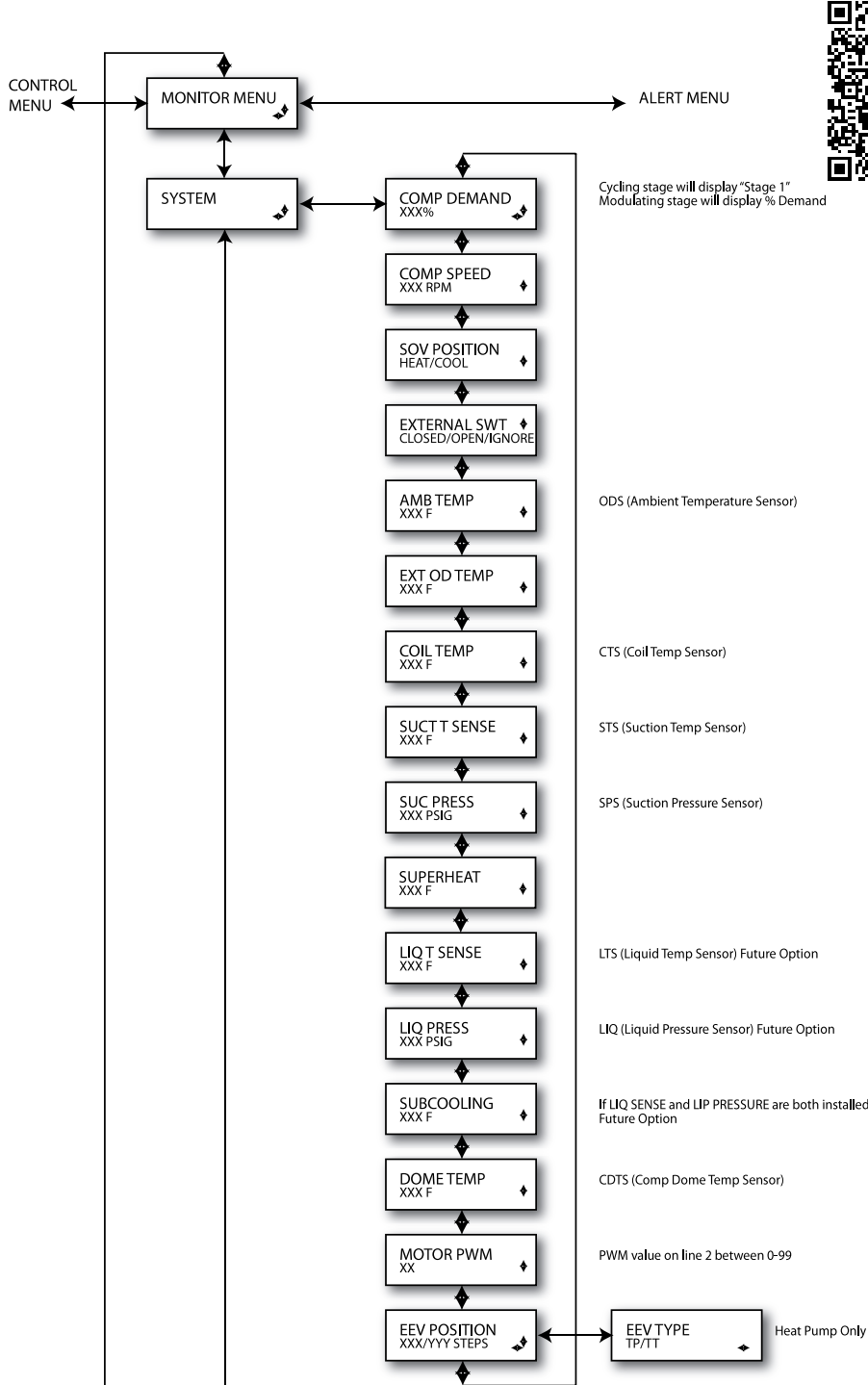

Scan to see a video about the CDA Monitor Menu

Continued on next page

Technician Monitor Menu

Continued from previous page

MONITOR MENU SYSTEM MENU

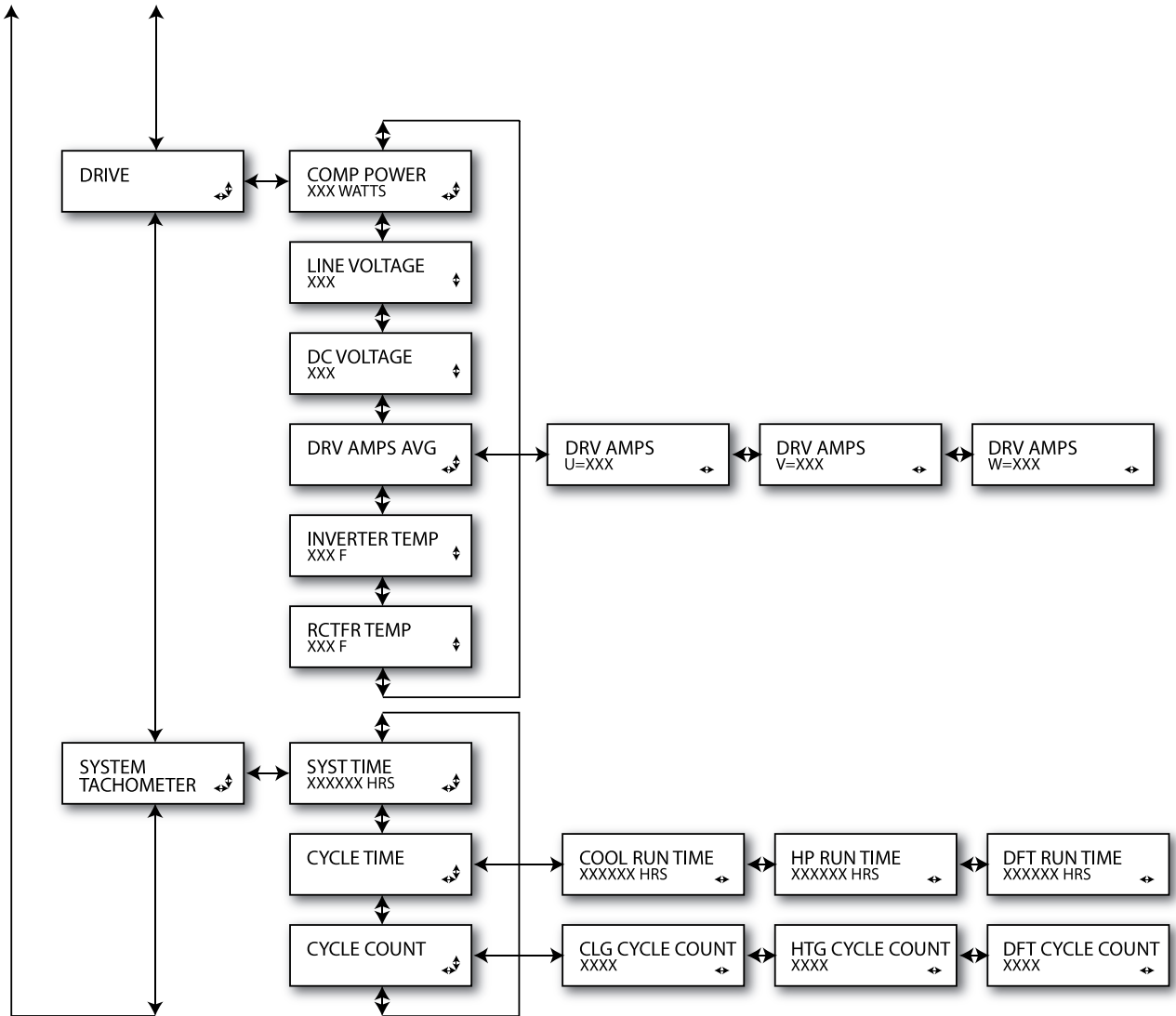

Technician Alert Menu

The Alert Menu displays active alerts.

Note: Clearing Alert History will also clear Active Alerts and will reset the Outdoor Control without the need to cycle power.

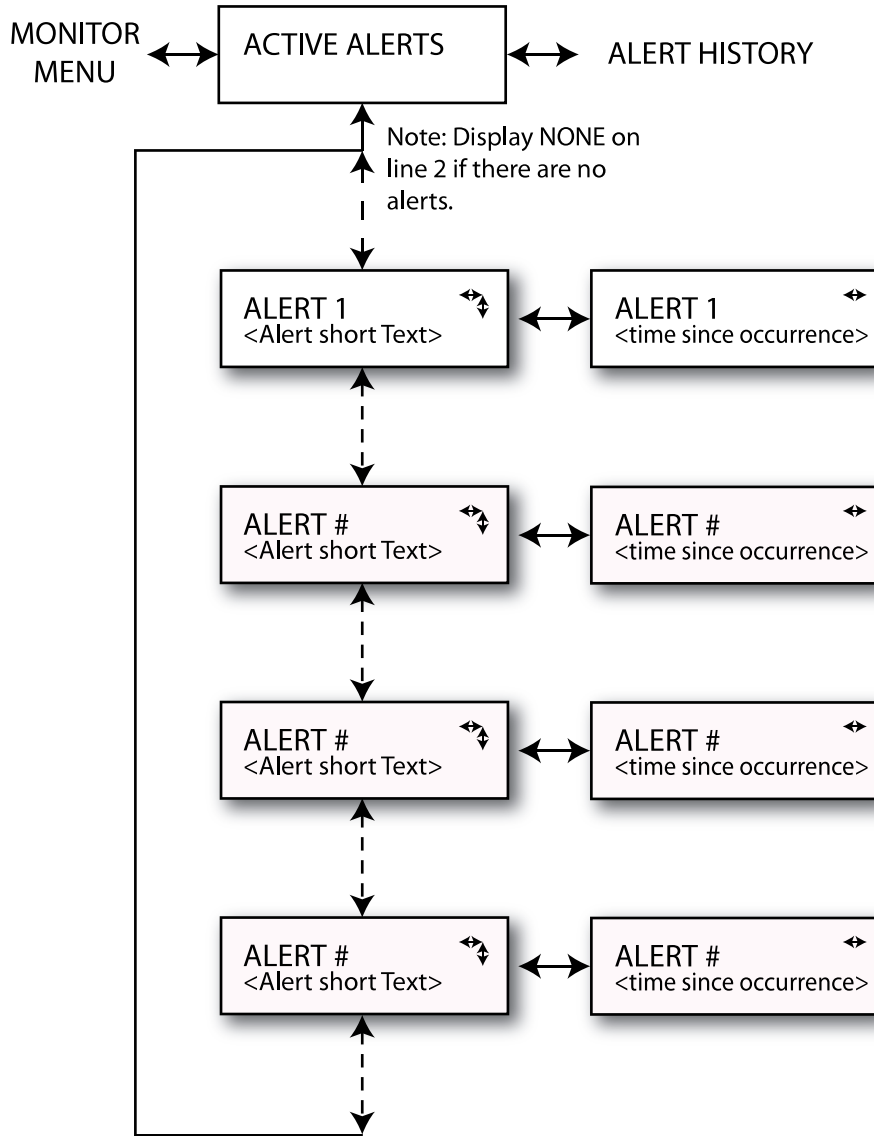

Scan to see a video about the CDA Alert Menu

Technician Alert History Menu

Note: Clearing Alert History will also clear Active Alerts and will reset the Outdoor Control without the need to cycle power.

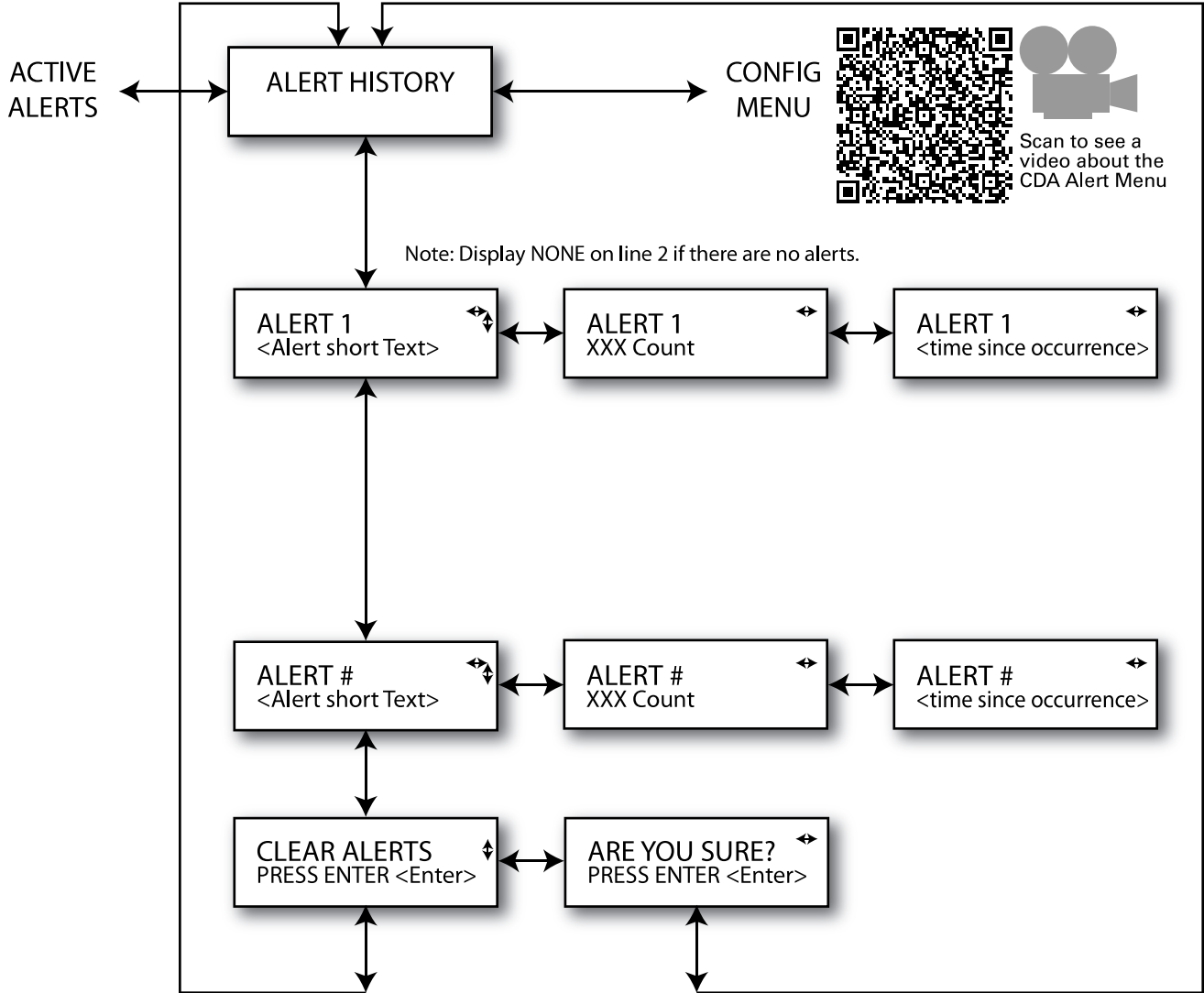

Note: When alert history is cleared, active alerts will be reset.

Resetting alerts will clear outdoor hard lockout conditions without the need to cycle power.

Technician Configuration Menu

System parameters and options are reported and set from the Config Menu.

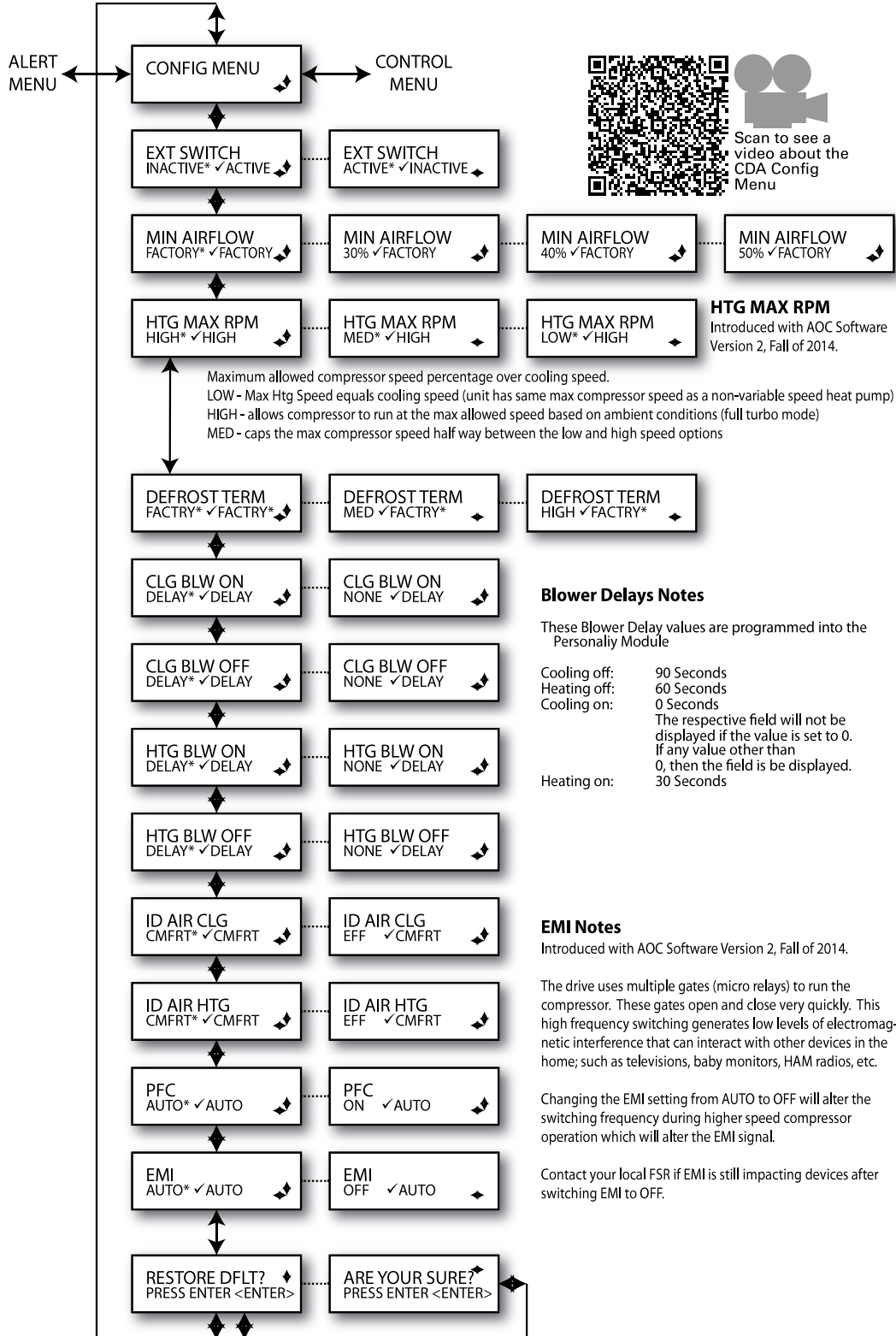

Technician Control Menu

Forced Defrost, EEV, LSOV, Evacuation, Run Drive and Run Outdoor Fan tests are initiated and performed from the Technician Control Menu.

Note: If system is in Lockout, Unit Tests are not available.

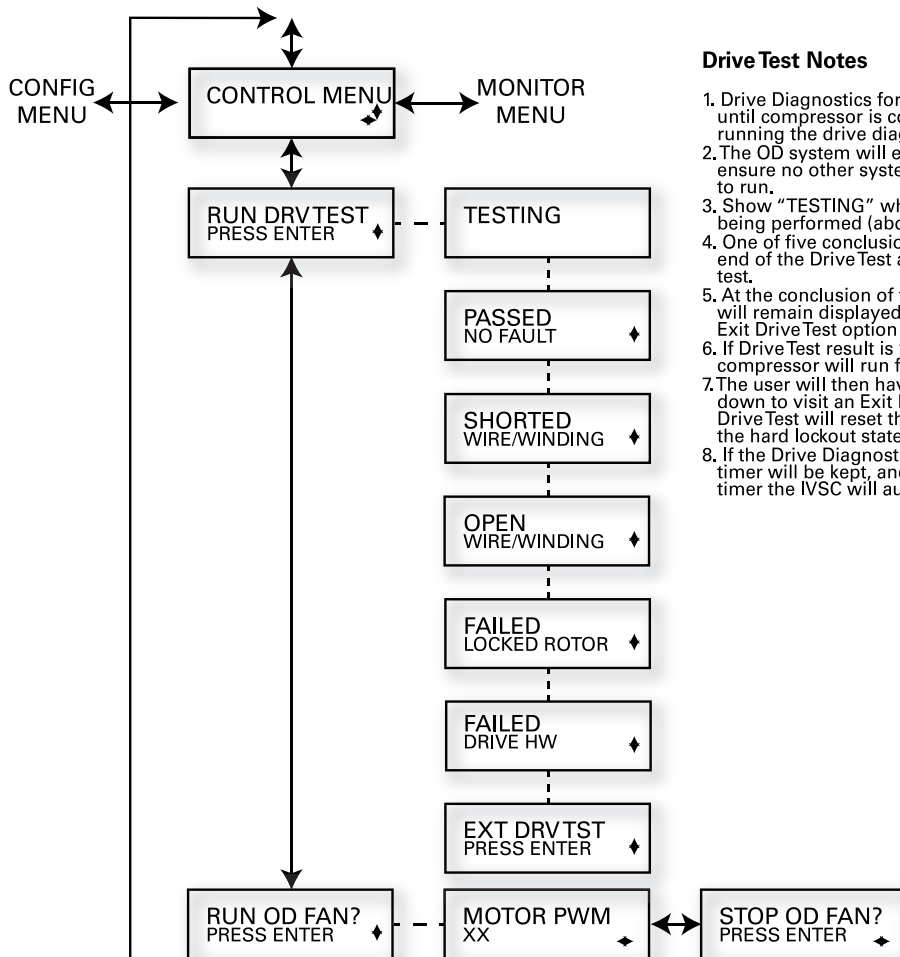

Drive Test Notes

1. Drive Diagnostics forces a shutdown and waits until compressor is completely coasted before running the drive diagnostic routine.
2. The OD system will enter a hard lockout state to ensure no other system component is attempting to run.
3. Show "TESTING" while internal diagnostics are being performed (about 30 seconds).
4. One of five conclusions will be displayed at the end of the Drive Test as a result of running the test.
5. At the conclusion of this test, the results screen will remain displayed until power is cycled or the Exit Drive Test option is used.
6. If Drive Test result is "Passed No Fault" the compressor will run for one minute.
7. The user will then have the ability to scroll up or down to visit an Exit Drive Test screen. Exiting the Drive Test will reset the IVSC software and clear the hard lockout state.
8. If the Drive Diagnostic test is not exited, a 2 hour timer will be kept, and upon expiration of that timer the IVSC will automatically reset itself.

Run OD Fan Test Procedure

The OD FanTest sends a high-speed command signal to the OD fan motor and can be used to verify motor and control operations.
If the OD Fan motor does not run:

1. Verify fan blades are free from obstruction and motor turns freely.
2. Confirm high voltage to OD Fan is present and in range (187VAC-252VAC).
3. Confirm high voltage leads are connected and not damaged.
4. Confirm motor is receiving a PWM signal by measuring DC Volts at plug J9 on the IVCS. High speed fan signal should measure between 15-18 Volts DC.
5. Confirm PWM motor plug (J9) and leads are connected and not damaged.

With all inputs and conditions verified, motor is defective.

Run OD Fan Test Notes

1. System can be in any mode but must be idle to enter RUN OD FAN test.
2. If thermostat is sending demand to the outdoor unit, RUN OD FAN test is not available.
3. Press ENTER from RUN OD FAN screen.
4. Send 99% PWM (100%CFM) to OD Fan Motor.
5. When test begins, change screen to display "MOTOR PWM" on line 1 and actual PWM value on line 2.
6. To end test, navigate to right and press ENTER from STOP OD FAN screen.
7. User should be able to navigate back and forth between the display screen and the STOP OD FAN screen.
8. Test terminates after 1 hour if STOP OD FAN step is not use.

continued on next page

Technician Control Menu

Continued from previous page

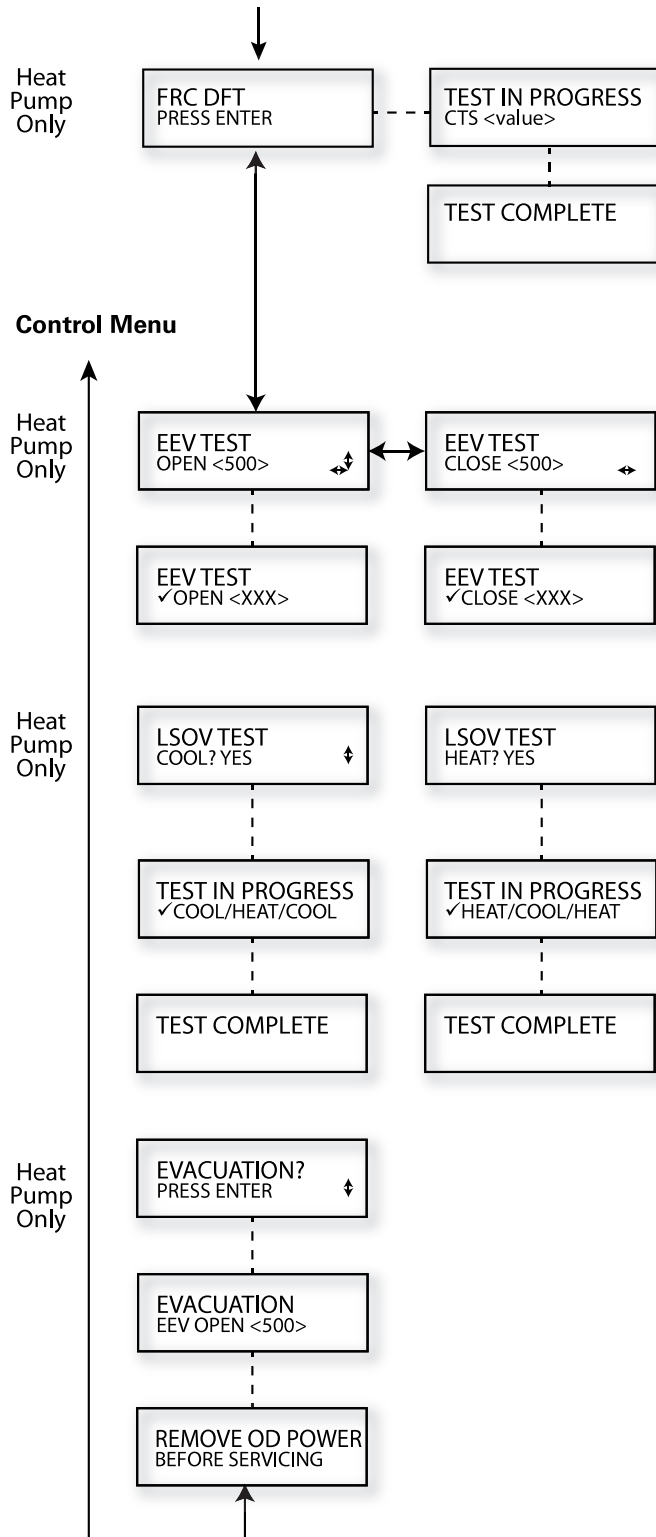

NOTES: Forced Defrost

1. System must be running with demand from the thermostat.
2. FRC DFT TEST can be initiated in heat mode.
3. Press ENTER to begin Forced Defrost.
4. Execute Forced Defrost following Defrost (Defrost terminates on Coil temperature or maximum time override of 15 minutes).
5. When test begins, display TEST IN PROGRESS on line 1 and Coil temperature value on line 2. Note: Home Screen, under System Status will display DEFROST.
6. When test is complete display TEST COMPLETE for 10 seconds.
7. If there is a defrost fault condition, stop test and send alert to the Alert Menu.
Note: Screens will update as the test proceeds.

EEV Test Mode Notes

1. The EEV test is allowed during Idle, Cooling, Heating and Forced Defrost Modes.
2. Select the OPEN or CLOSE test by navigating left or right.
3. Press ENTER from EEV TEST screen to begin EEV test.
4. Check mark indicates test is in progress and valve position will be displayed on line 2. Note: Screens will update as test proceeds.
5. OPEN test terminates after 30 seconds.
6. At end of test remove check mark in front of OPEN and return to controlling valve position or last known position if system is idle.
7. CLOSE test terminates after 90 seconds.
8. At end of test remove check mark in front of CLOSED and return to controlling valve position or last known position if system is idle.
9. If there is an EEV fault condition, stop test and send alert to the Alert Menu.

LSOV Test Notes

1. System must be running with demand from the thermostat.
2. LSOV TEST can be initiated in heating mode or cooling mode. Note: During HEAT mode, only heat-mode LSOV test is allowed and available. *Note: During COOL mode, only cool-mode LSOV test is allowed and available. *
3. Press ENTER to begin test.
4. During TEST IN PROGRESS, display a check mark in front of the current mode but update screen text as mode changes per test sequence.
5. Test sequence will pulse the SOV coil in the order displayed, and wait 10 seconds between each directional pulse.
6. When test is complete, display TEST COMPLETE for 10 seconds.
7. If there is an LSOV fault condition, stop test and send alert to the Alert Menu. Note: LSOV test will not available during defrost.
* During LSOV TEST, if a mode change request is received, the LSOV test will terminate.

Evacuation Notes

1. Press enter to execute EVACUATION mode.
2. Entering EVACUATION puts the OD system into a hard lockout state.
3. Send alert Err 18700 to communicating thermostat.
4. Ignore all thermostat demand until hard lockout is cleared by power cycle.
5. Open EEV and remain at the full open position until power is cycled (open ID EEV – Phase2).
6. During EVACUATION mode, display EEV valve position as OPEN <500> on line 2 (EEV shall be at 500 step position).
7. If there is an EEV fault condition, stop test mode and send alert to the alert menu.
8. Technician to follow on-screen note to 'Remove power before servicing.'
Note: See Evacuation Mode write-up on Control Notes page.

TECH CONTROL — Charge/Check Charge Modes

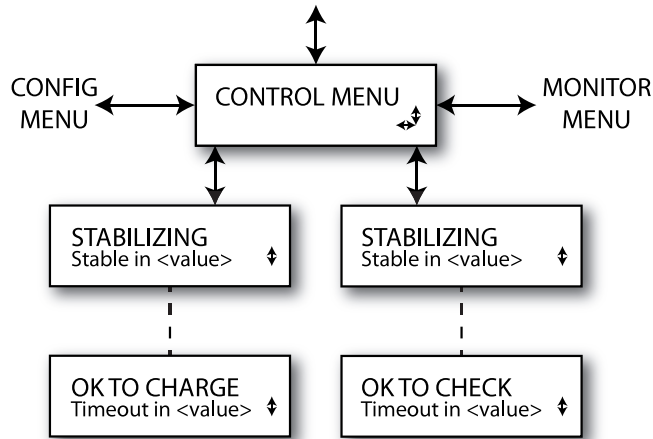

Charge / Check Charge Notes

Introduced with AOC Software Version 2, Fall of 2014.

After initiating the Charging or Check Charge Mode from the comfort control, the OD unit CDA enters the Control Menu and the corresponding screen (ok to charge for the cooling test mode & ok to check for heating test mode) appears.

Upon test initiation, the CDA will show stabilizing along with the countdown timer from 20 to 0 minutes, then the screen immediately changes to the appropriate screen ('OK to charge' in cooling test mode and 'OK to check' in heating test mode). The new screen will populate a countdown timer that counts down from 100 to 0 minutes.

The CDA reverts to the home screen when the comfort control exits test mode.

If the technician 'adds time' to the comfort control test mode, the CDA will remain at 0 minutes until the comfort control timer expires and exits the test mode.

The technician has the ability to navigate through the Control Menu or other Menu Trees to evaluate system performance or perform other component tests during these tests.

Note: CHECK CHARGE screens not available on Cooling only units

Pressure Curves

Figure 20. 4A6V8024A

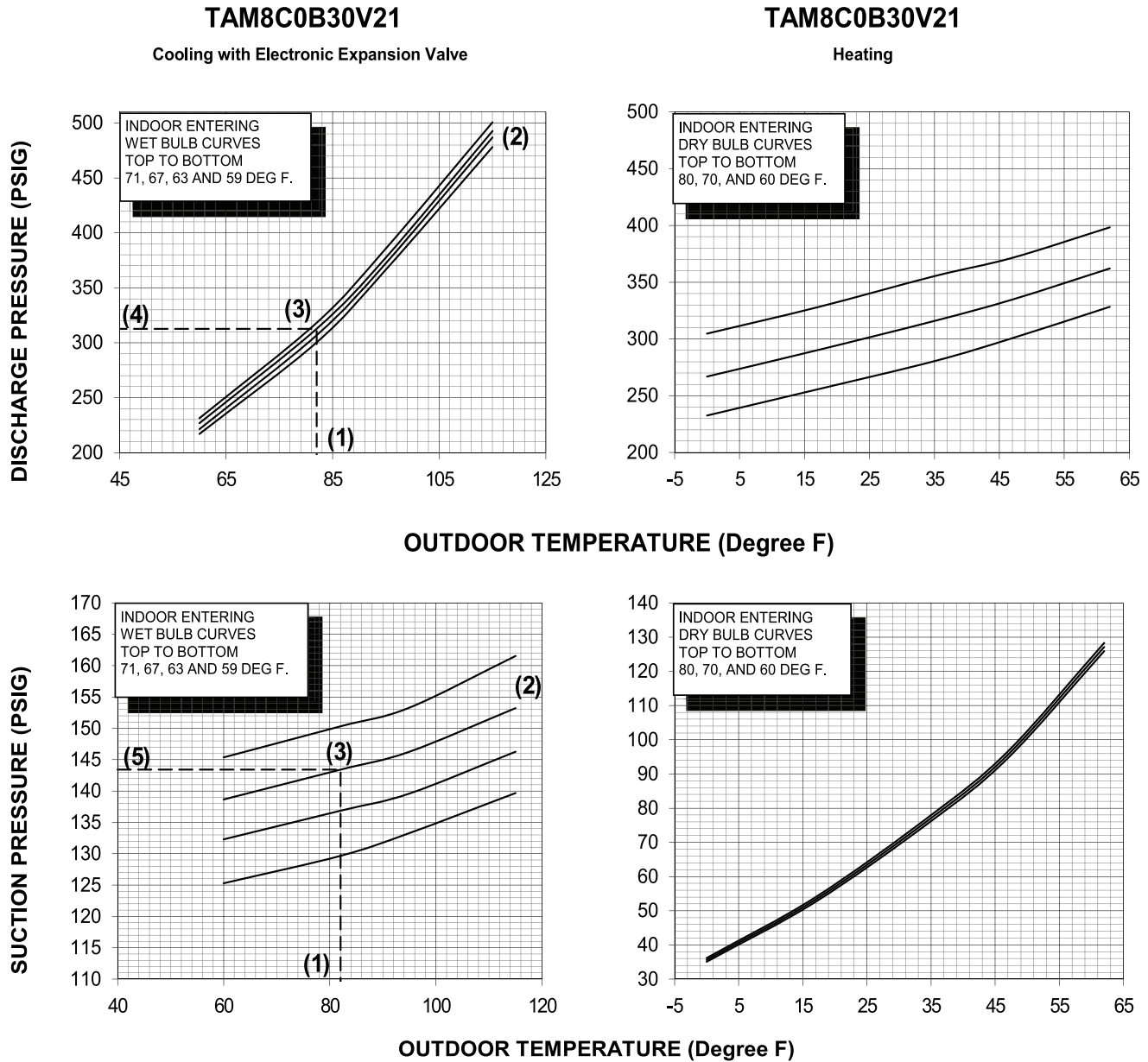

COOLING PERFORMANCE CAN BE CHECKED WHEN THE OUTDOOR TEMP IS ABOVE 55F.
 * WHEN USING PRESSURE CURVES TO VERIFY TYPICAL PERFORMANCE, ALWAYS RUN THE SYSTEM WITH ONE OF THE TEST MODES FOUND IN THE 950/850 COMFORT CONTROL. CHARGING MODE - COOLING OR CHECK CHARGE MODE - HEATING. TO CHECK COOLING PERFORMANCE, SELECT THE PROPER INDOOR CFM, ALLOW PRESSURES TO STABILIZE. MEASURE INDOOR WET BULB TEMPERATURE, OUTDOOR TEMPERATURE, LIQUID AND SUCTION PRESSURES. ON THE PLOTS, LOCATE OUTDOOR TEMPERATURE (1); LOCATE INDOOR WET BULB (2); FIND INTERSECTION OF OD TEMP & ID W.B. (3); READ DISCHARGE (4) OR SUCTION PRESSURE (5) IN LEFT COLUMN.

EXAMPLE: (1) OUTDOOR TEMP. 82 F.
 (2) INDOOR WET BULB 67 F.
 (3) AT INTERSECTION
 (4) DISCHARGE PRESSURE @ 850 CFM IS 313 PSIG
 (5) SUCTION PRESSURE @ 850 CFM IS 143 PSIG

ACTUAL:
 LIQUID PRESSURE SHOULD BE +/- 10 PSI OF CHART
 SUCTION PRESSURE SHOULD BE +/- 3 PSIG OF CHART

INTERCONNECTING LINES
GAS - 5/8" O.D.
LIQUID - 3/8"

DWG. NO. 4A6V8024A

Figure 21. 4A6V8036A

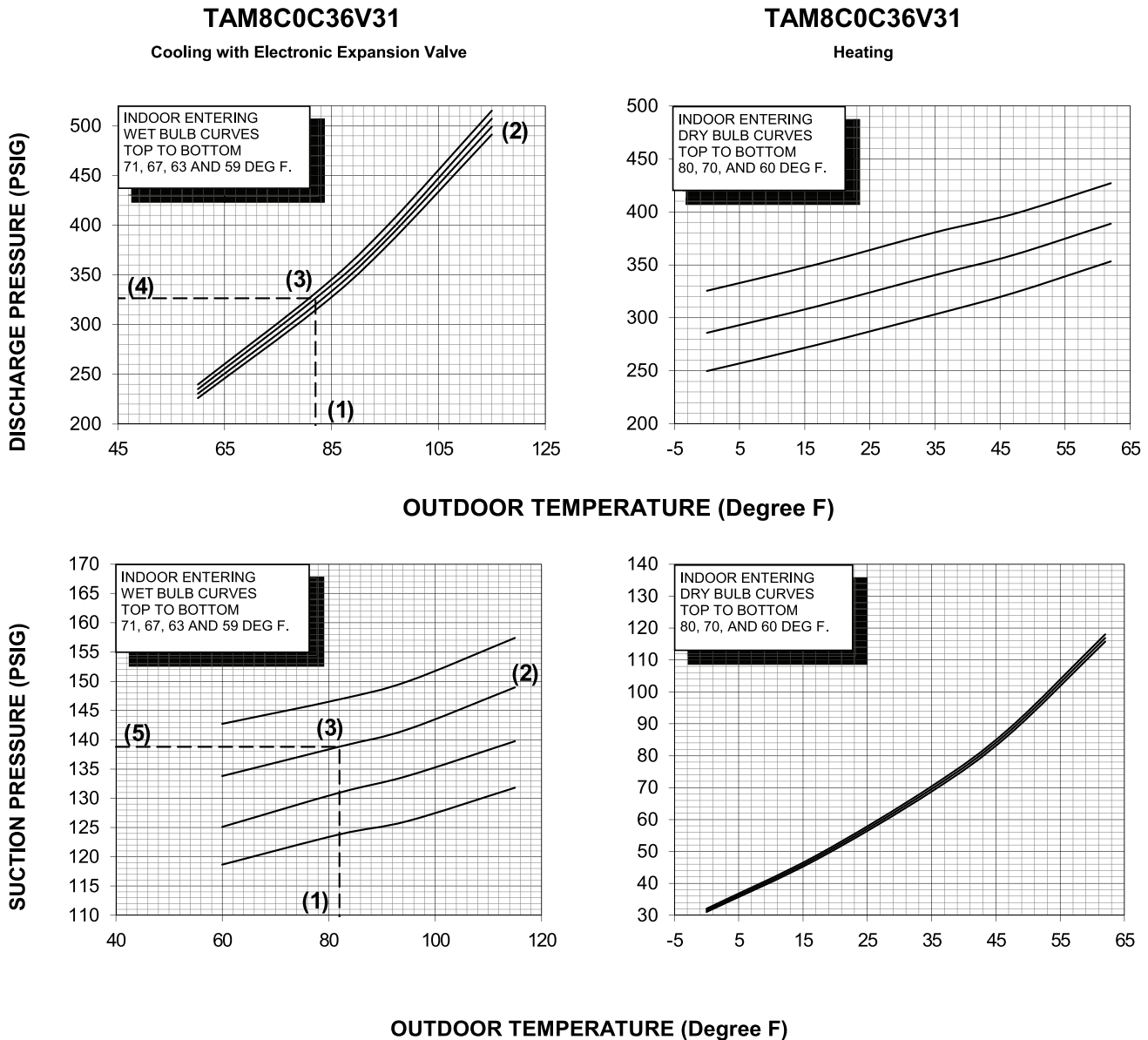

COOLING PERFORMANCE CAN BE CHECKED WHEN THE OUTDOOR TEMP IS ABOVE 55F.

* WHEN USING PRESSURE CURVES TO VERIFY TYPICAL PERFORMANCE, ALWAYS RUN THE SYSTEM WITH ONE OF THE TEST MODES FOUND IN THE 950/850 COMFORT CONTROL. CHARGING MODE - COOLING OR CHECK CHARGE MODE - HEATING. TO CHECK COOLING PERFORMANCE, SELECT THE PROPER INDOOR CFM, ALLOW PRESSURES TO STABILIZE. MEASURE INDOOR WET BULB TEMPERATURE, OUTDOOR TEMPERATURE, LIQUID AND SUCTION PRESSURES. ON THE PLOTS, LOCATE OUTDOOR TEMPERATURE (1); LOCATE INDOOR WET BULB (2); FIND INTERSECTION OF OD TEMP. & ID W.B. (3); READ DISCHARGE (4) OR SUCTION PRESSURE (5) IN LEFT COLUMN.

EXAMPLE: (1) OUTDOOR TEMP 82 F
(2) INDOOR WET BULB 67 F
(3) AT INTERSECTION
(4) DISCHARGE PRESSURE @ 1400 CFM IS 326 PSIG
(5) SUCTION PRESSURE @ 1400 CFM IS 139 PSIG

ACTUAL:
LIQUID PRESSURE SHOULD BE +/- 10 PSI OF CHART
SUCTION PRESSURE SHOULD BE +/- 3 PSIG OF CHART

INTERCONNECTING LINES
GAS - 3/4" O.D.
LIQUID - 3/8"

DWG. NO. 4A6V8036A

Pressure Curves

Figure 22. 4A6V8037A

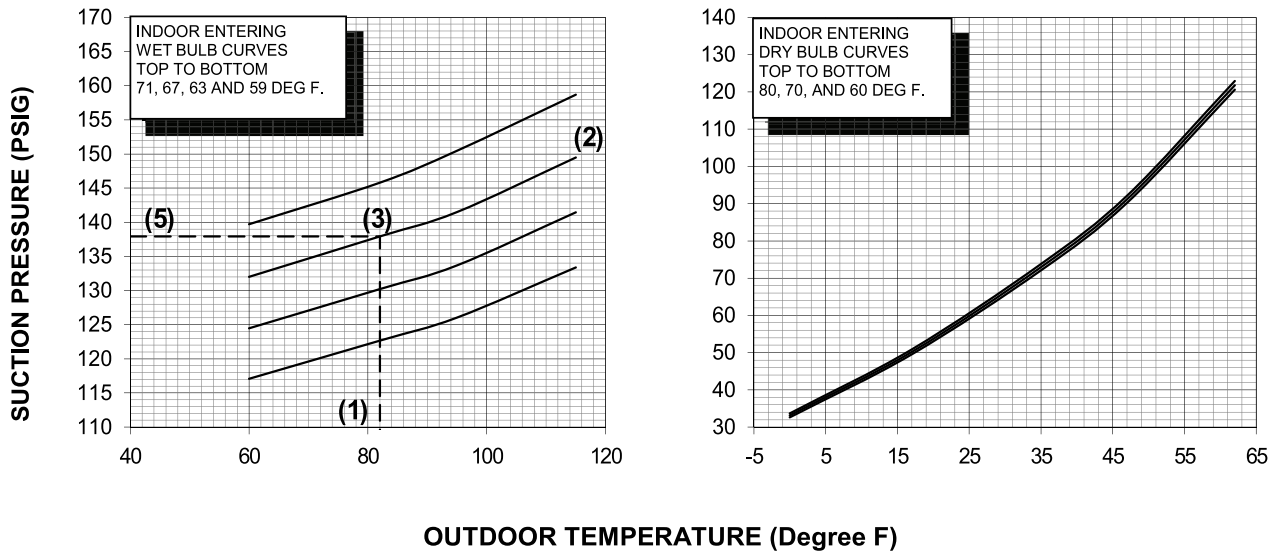
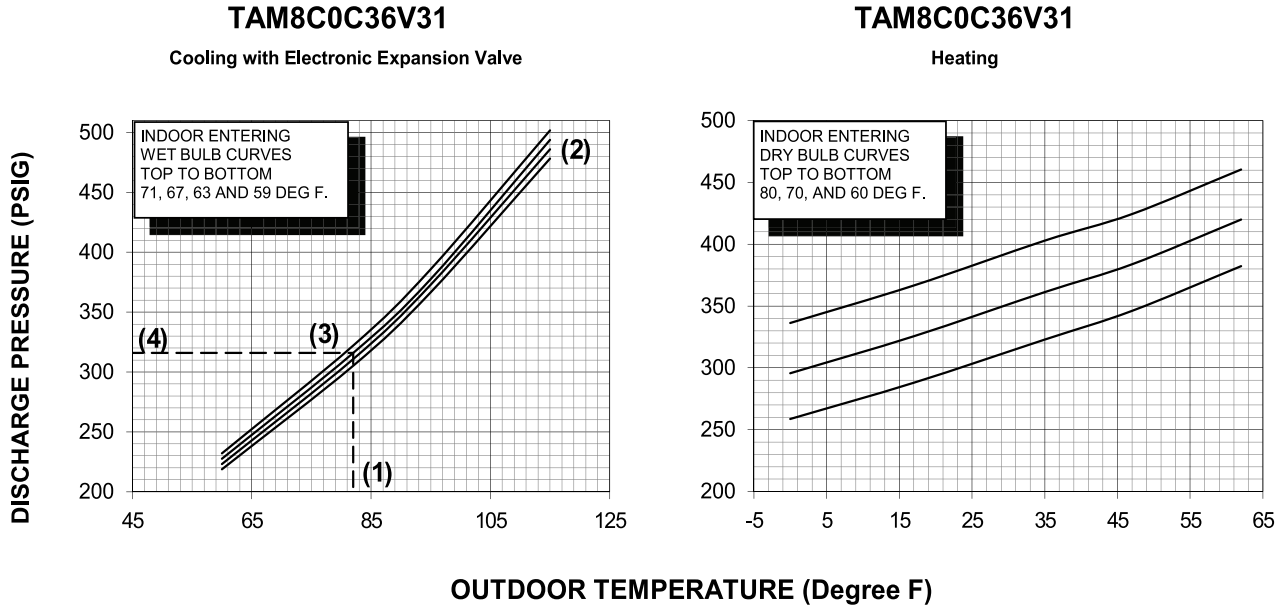

COOLING PERFORMANCE CAN BE CHECKED WHEN THE OUTDOOR TEMP IS ABOVE 55F.

* WHEN USING PRESSURE CURVES TO VERIFY TYPICAL PERFORMANCE, ALWAYS RUN THE SYSTEM WITH ONE OF THE TEST MODES FOUND IN THE 950/850 COMFORT CONTROL. CHARGING MODE - COOLING OR CHECK CHARGE MODE - HEATING.

TO CHECK COOLING PERFORMANCE, SELECT THE PROPER INDOOR CFM, ALLOW PRESSURES TO STABILIZE. MEASURE INDOOR WET BULB TEMPERATURE, OUTDOOR TEMPERATURE, LIQUID AND SUCTION PRESSURES. ON THE PLOTS, LOCATE OUTDOOR TEMPERATURE (1); LOCATE INDOOR WET BULB (2); FIND INTERSECTION OF OD TEMP. & ID W.B. (3); READ DISCHARGE (4) OR SUCTION PRESSURE (5) IN LEFT COLUMN.

- EXAMPLE: (1) OUTDOOR TEMP. 82 F.
 (2) INDOOR WET BULB 67 F.
 (3) AT INTERSECTION
 (4) DISCHARGE PRESSURE @ 1400 CFM IS 316 PSIG
 (5) SUCTION PRESSURE @ 1400 CFM IS 138 PSIG

ACTUAL:
 LIQUID PRESSURE SHOULD BE +/- 10 PSI OF CHART
 SUCTION PRESSURE SHOULD BE +/- 3 PSIG OF CHART

INTERCONNECTING LINES
 GAS - 3/4" O.D.
 LIQUID - 3/8"

DWG. NO. 4A6V8037A

Figure 23. 4A6V8048A

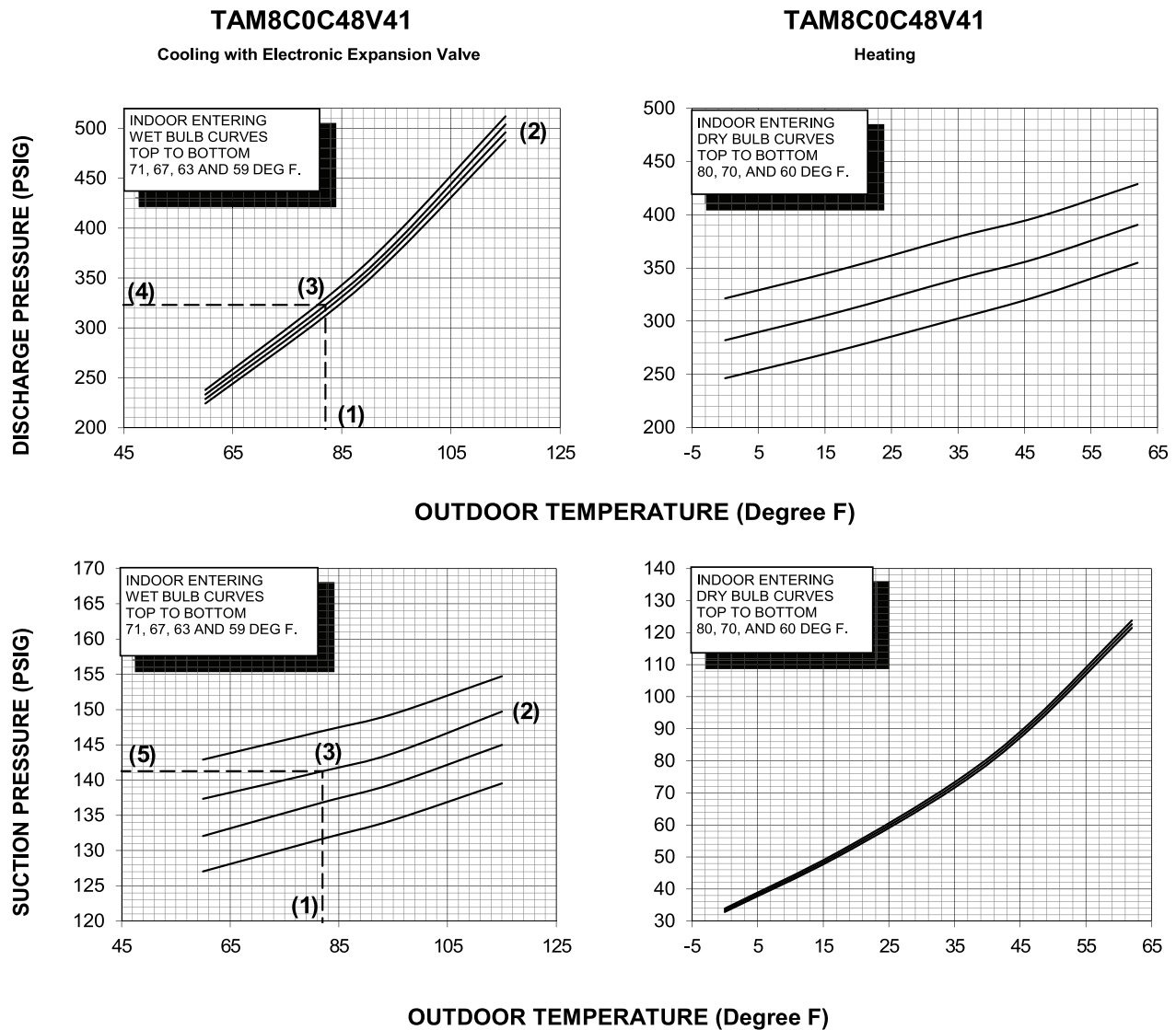

COOLING PERFORMANCE CAN BE CHECKED WHEN THE OUTDOOR TEMP IS ABOVE 55F.

* WHEN USING PRESSURE CURVES TO VERIFY TYPICAL PERFORMANCE, ALWAYS RUN THE SYSTEM WITH ONE OF THE TEST MODES FOUND IN THE 950/850 COMFORT CONTROL. CHARGING MODE - COOLING OR CHECK CHARGE MODE - HEATING. TO CHECK COOLING PERFORMANCE, SELECT THE PROPER INDOOR CFM, ALLOW PRESSURES TO STABILIZE. MEASURE INDOOR WET BULB TEMPERATURE, OUTDOOR TEMPERATURE, LIQUID AND SUCTION PRESSURES. ON THE PLOTS, LOCATE OUTDOOR TEMPERATURE (1); LOCATE INDOOR WET BULB (2); FIND INTERSECTION OF OD TEMP & ID W.B. (3); READ DISCHARGE (4) OR SUCTION PRESSURE (5) IN LEFT COLUMN.

EXAMPLE: (1) OUTDOOR TEMP 82 F
(2) INDOOR WET BULB 67 F
(3) AT INTERSECTION
(4) DISCHARGE PRESSURE @ 1800 CFM IS 323 PSIG
(5) SUCTION PRESSURE @ 1800 CFM IS 141 PSIG

ACTUAL:
LIQUID PRESSURE SHOULD BE +/- 10 PSI OF CHART
SUCTION PRESSURE SHOULD BE +/- 3 PSIG OF CHART

INTERCONNECTING LINES
GAS - 7/8" O.D.
LIQUID - 3/8"

DWG. NO. 4A6V8048A

Pressure Curves

Figure 24. 4A6V8049A

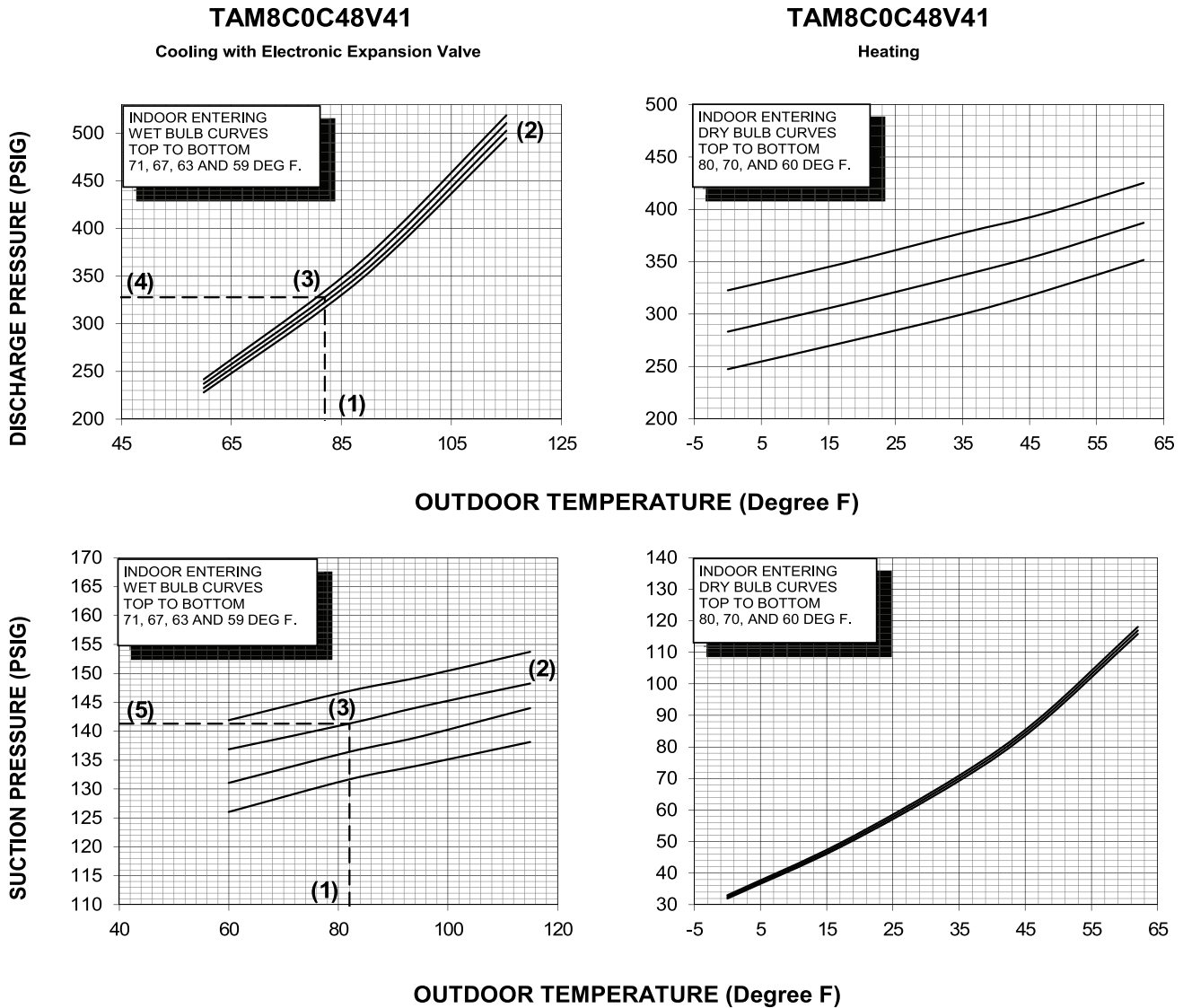

COOLING PERFORMANCE CAN BE CHECKED WHEN THE OUTDOOR TEMP IS ABOVE 55F.

* WHEN USING PRESSURE CURVES TO VERIFY TYPICAL PERFORMANCE, ALWAYS RUN THE SYSTEM WITH ONE OF THE TEST MODES FOUND IN THE 950/850 COMFORT CONTROL. CHARGING MODE - COOLING OR CHECK CHARGE MODE - HEATING.

TO CHECK COOLING PERFORMANCE, SELECT THE PROPER INDOOR CFM, ALLOW PRESSURES TO STABILIZE. MEASURE INDOOR WET BULB TEMPERATURE, OUTDOOR TEMPERATURE, LIQUID AND SUCTION PRESSURES. ON THE PLOTS, LOCATE OUTDOOR TEMPERATURE (1); LOCATE INDOOR WET BULB (2); FIND INTERSECTION OF OD TEMP. & ID W.B. (3); READ DISCHARGE (4) OR SUCTION PRESSURE (5) IN LEFT COLUMN.

- EXAMPLE: (1) OUTDOOR TEMP. 82 F.
 (2) INDOOR WET BULB 67 F.
 (3) AT INTERSECTION
 (4) DISCHARGE PRESSURE @ 1800 CFM IS 328 PSIG
 (5) SUCTION PRESSURE @ 1800 CFM IS 141 PSIG

ACTUAL:
 LIQUID PRESSURE SHOULD BE +/- 10 PSI OF CHART
 SUCTION PRESSURE SHOULD BE +/- 3 PSIG OF CHART

INTERCONNECTING LINES
 GAS - 7/8" O.D.
 LIQUID - 3/8"

DWG. NO. 4A6V8049A

Figure 25. 4A6V8060A

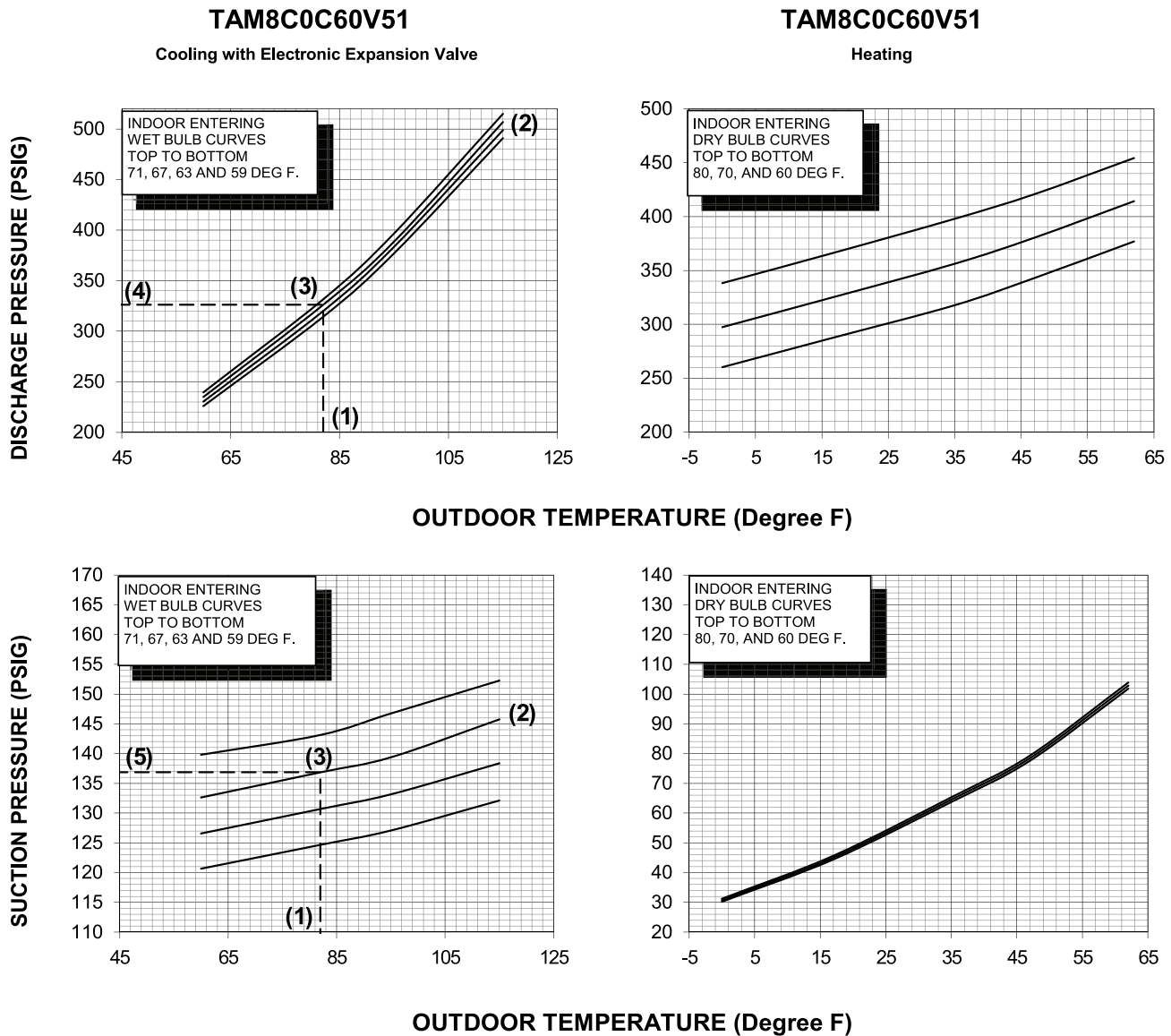

COOLING PERFORMANCE CAN BE CHECKED WHEN THE OUTDOOR TEMP IS ABOVE 55F.

* WHEN USING PRESSURE CURVES TO VERIFY TYPICAL PERFORMANCE, ALWAYS RUN THE SYSTEM WITH ONE OF THE TEST MODES FOUND IN THE 950/850 COMFORT CONTROL. CHARGING MODE - COOLING OR CHECK CHARGE MODE - HEATING. TO CHECK COOLING PERFORMANCE, SELECT THE PROPER INDOOR CFM, ALLOW PRESSURES TO STABILIZE. MEASURE INDOOR WET BULB TEMPERATURE, OUTDOOR TEMPERATURE, LIQUID AND SUCTION PRESSURES. ON THE PLOTS, LOCATE OUTDOOR TEMPERATURE (1); LOCATE INDOOR WET BULB (2); FIND INTERSECTION OF OD TEMP. & ID W.B. (3); READ DISCHARGE (4) OR SUCTION PRESSURE (5) IN LEFT COLUMN.

EXAMPLE: (1) OUTDOOR TEMP 82 F
(2) INDOOR WET BULB 67 F.
(3) AT INTERSECTION
(4) DISCHARGE PRESSURE @ 2100 CFM IS 326 PSIG
(5) SUCTION PRESSURE @ 2100 CFM IS 137 PSIG

ACTUAL:
LIQUID PRESSURE SHOULD BE +/- 10 PSI OF CHART
SUCTION PRESSURE SHOULD BE +/- 3 PSIG OF CHART

INTERCONNECTING LINES
GAS - 1 - 1/8" O.D.
LIQUID - 3/8"

DWG. NO. 4A6V8060A

Pressure Curves

Figure 26. 4A7V8024A

4TXCB003CC3
Cooling with Thermal Expansion Valve

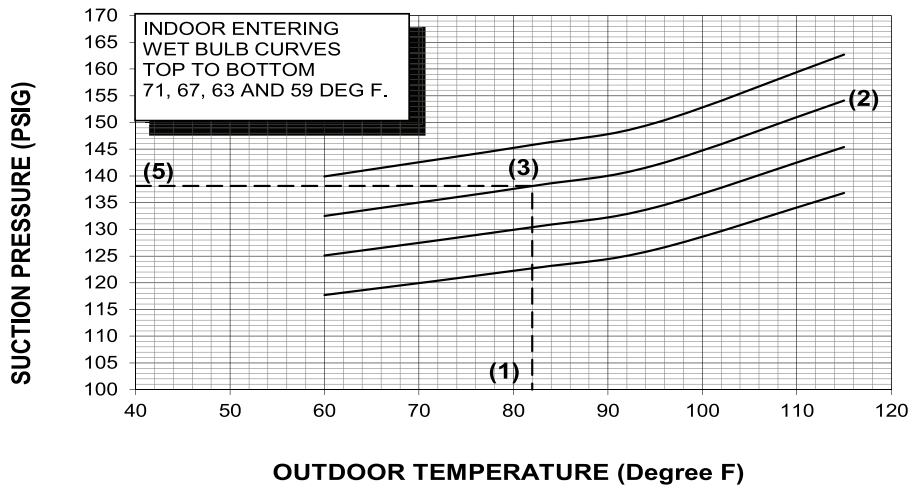
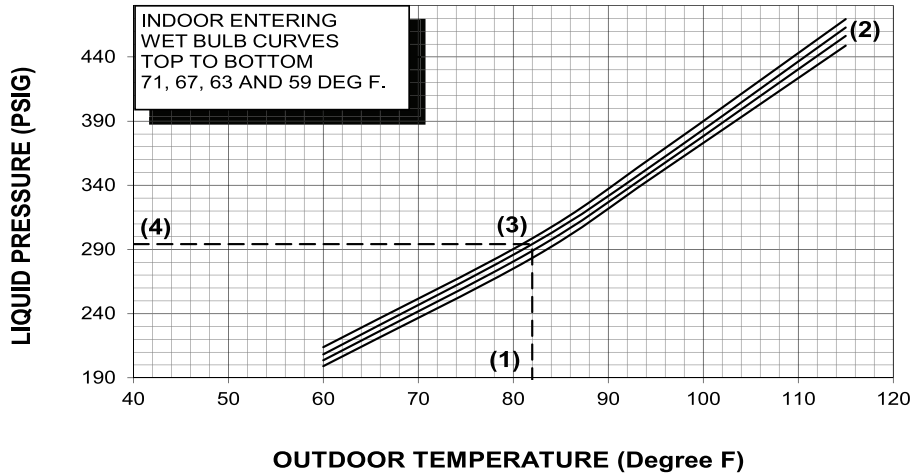

COOLING PERFORMANCE CAN BE CHECKED WHEN THE OUTDOOR TEMP IS ABOVE 55F.

* WHEN USING PRESSURE CURVES TO VERIFY TYPICAL PERFORMANCE, ALWAYS RUN THE SYSTEM WITH ONE OF THE TEST MODES FOUND IN THE 950/850 COMFORT CONTROL, CHARGING MODE - COOLING.

TO CHECK COOLING PERFORMANCE, SELECT THE PROPER INDOOR CFM, ALLOW PRESSURES TO STABILIZE. MEASURE INDOOR WET BULB TEMPERATURE, OUTDOOR TEMPERATURE, LIQUID AND SUCTION PRESSURES. ON THE PLOTS, LOCATE OUTDOOR TEMPERATURE (1); LOCATE INDOOR WET BULB (2); FIND INTERSECTION OF OD TEMP. & ID W.B. (3); READ LIQUID (4) OR SUCTION (5) PRESSURE IN LEFT COLUMN.

- EXAMPLE: (1) OUTDOOR TEMP. 82 F.
 (2) INDOOR WET BULB 67 F.
 (3) AT INTERSECTION
 (4) LIQUID PRESSURE @ 1070 CFM IS 294 PSIG
 (5) SUCTION PRESSURE @ 1070 CFM IS 138 PSIG

ACTUAL:
 LIQUID PRESSURE SHOULD BE +/- 10 PSI OF CHART
 SUCTION PRESSURE SHOULD BE +/- 3 PSIG OF CHART

INTERCONNECTING LINES
 GAS - 5/8" O.D.
 LIQUID - 3/8"

DWG. NO. 4A7V8024A

Figure 27. 4A7V8036A
4TXCB004CC3HCB
Cooling with Thermal Expansion Valve

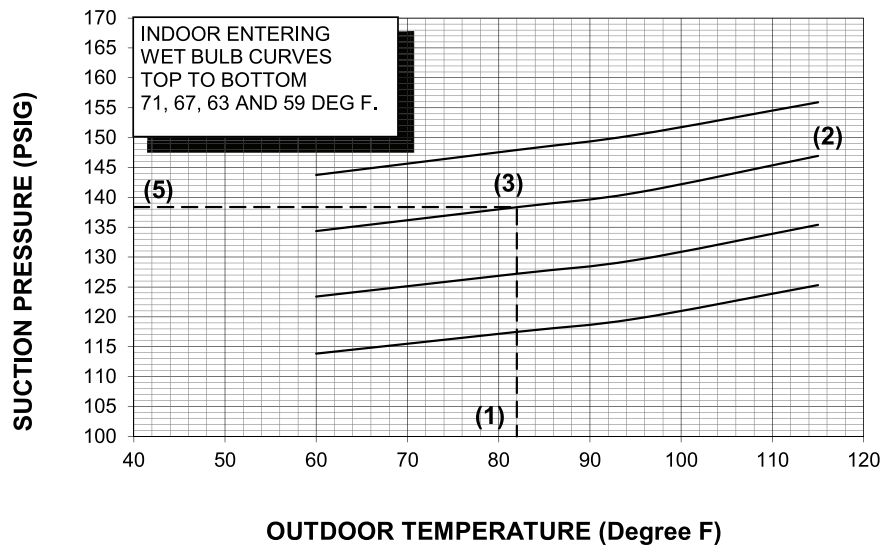
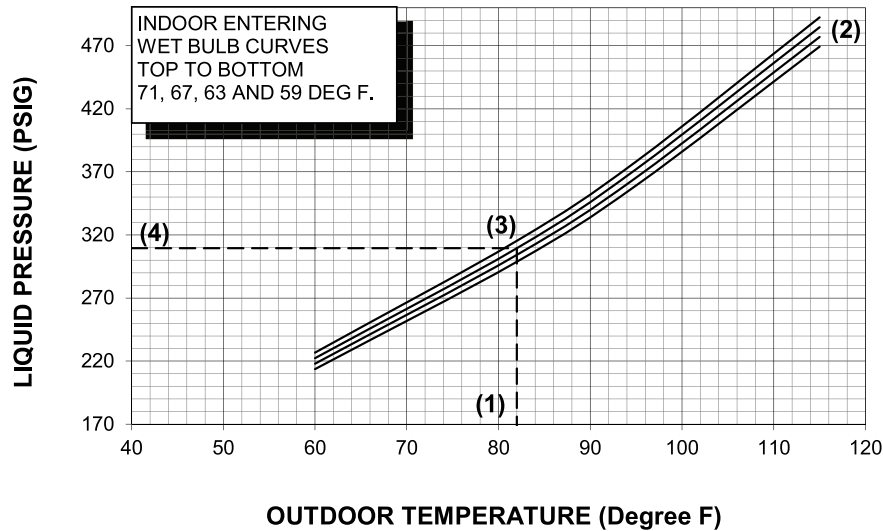

COOLING PERFORMANCE CAN BE CHECKED WHEN THE OUTDOOR TEMP IS ABOVE 55F
 * WHEN USING PRESSURE CURVES TO VERIFY TYPICAL PERFORMANCE, ALWAYS RUN THE SYSTEM WITH ONE OF THE TEST MODES FOUND IN THE 950/850 COMFORT CONTROL. CHARGING MODE - COOLING.
 TO CHECK COOLING PERFORMANCE, SELECT THE PROPER INDOOR CFM, ALLOW PRESSURES TO STABILIZE. MEASURE INDOOR WET BULB TEMPERATURE, OUTDOOR TEMPERATURE, LIQUID AND SUCTION PRESSURES. ON THE PLOTS, LOCATE OUTDOOR TEMPERATURE (1); LOCATE INDOOR WET BULB (2); FIND INTERSECTION OF OD TEMP. & ID W.B. (3); READ LIQUID (4) OR SUCTION (5) PRESSURE IN LEFT COLUMN.

EXAMPLE: (1) OUTDOOR TEMP 82 F
 (2) INDOOR WET BULB 67 F
 (3) AT INTERSECTION
 (4) LIQUID PRESSURE @ 1050 CFM IS 310 PSIG
 (5) SUCTION PRESSURE @ 1050 CFM IS 138 PSIG

ACTUAL:
 LIQUID PRESSURE SHOULD BE +/- 10 PSI OF CHART
 SUCTION PRESSURE SHOULD BE +/- 3 PSIG OF CHART

INTERCONNECTING LINES
 GAS - 3/4" O.D.
 LIQUID - 3/8"

DWG. NO. 4A7V8036A

Pressure Curves

Figure 28. 4A7V8037A

TAM8C0C36V31

Cooling with Electronic Expansion Valve

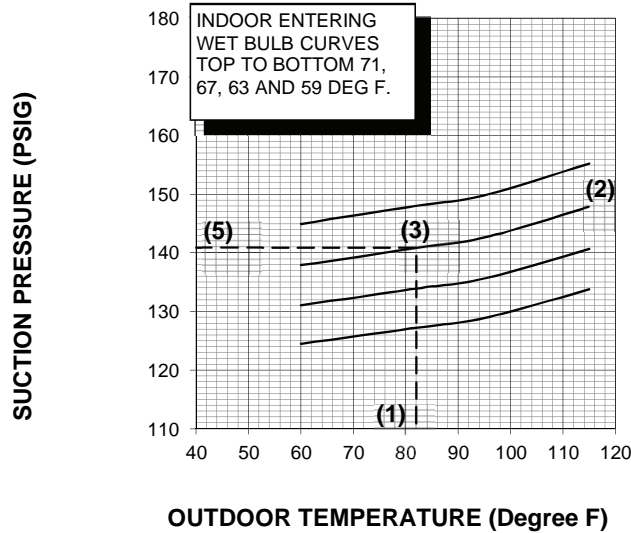
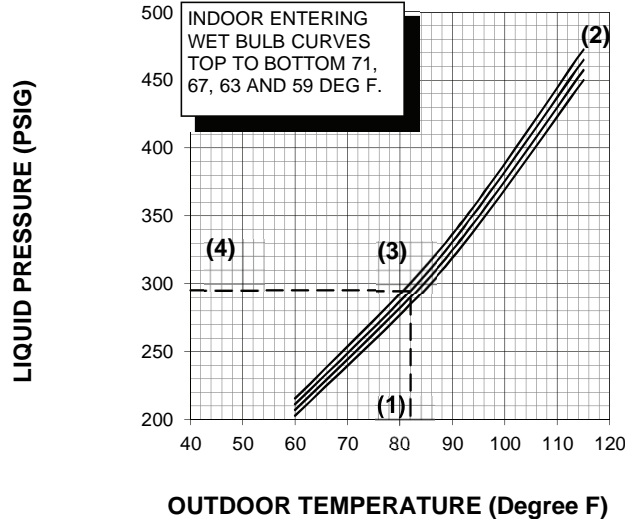

COOLING PERFORMANCE CAN BE CHECKED WHEN THE OUTDOOR TEMP IS ABOVE 65 DEG F.
TO CHECK COOLING PERFORMANCE, SELECT THE PROPER INDOOR CFM, ALLOW PRESSURES TO STABILIZE. MEASURE INDOOR WET BULB TEMPERATURE, OUTDOOR TEMPERATURE, LIQUID AND SUCTION PRESSURES. ON THE PLOTS LOCATE OUTDOOR TEMPERATURE (1); LOCATE INDOOR WET BULB (2); FIND INTERSECTION OF OD TEMP. & ID W.B. (3); READ LIQUID (4) OR SUCTION (5) PRESSURE IN LEFT COLUMN .

- EXAMPLE: FIRST STAGE
- (1) OUTDOOR TEMP. 82 F.
 - (2) INDOOR WET BULB 67 F.
 - (3) AT INTERSECTION
 - (4) LIQUID PRESSURE @ 400 CFM IS 295 PSIG
 - (5) SUCTION PRESSURE @ 1050 CFM IS 141 PSIG

INTERCONNECTING LINES
GAS - 3/4" O.D.
LIQUID - 3/8" O.D.

ACTUAL:
LIQUID PRESSURE SHOULD BE +/- 10 PSI OF CHART
SUCTION PRESSURE SHOULD BE +/- 3 PSIG OF CHART

DWG.NO. 4A7V8037A1

Figure 29. 4A7V8048A
TAM8C0C48V41
Cooling with Electronic Expansion Valve

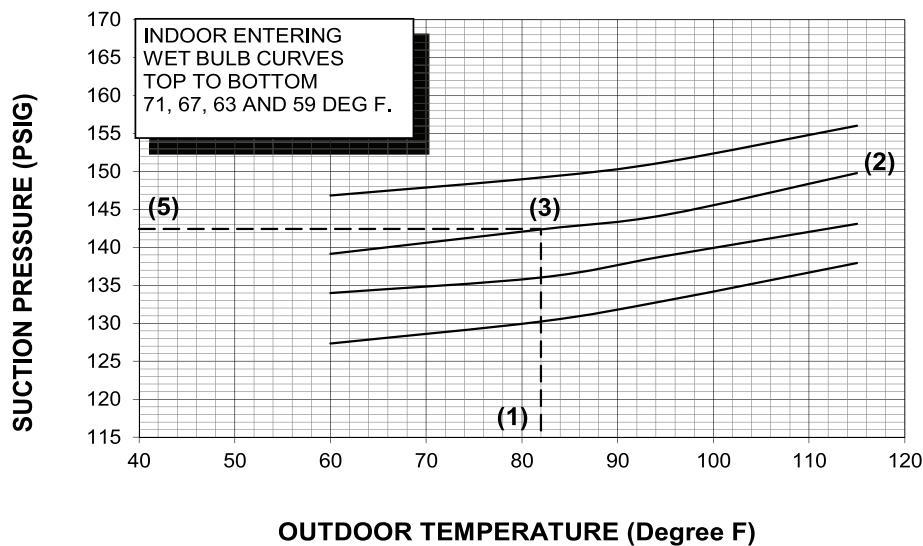
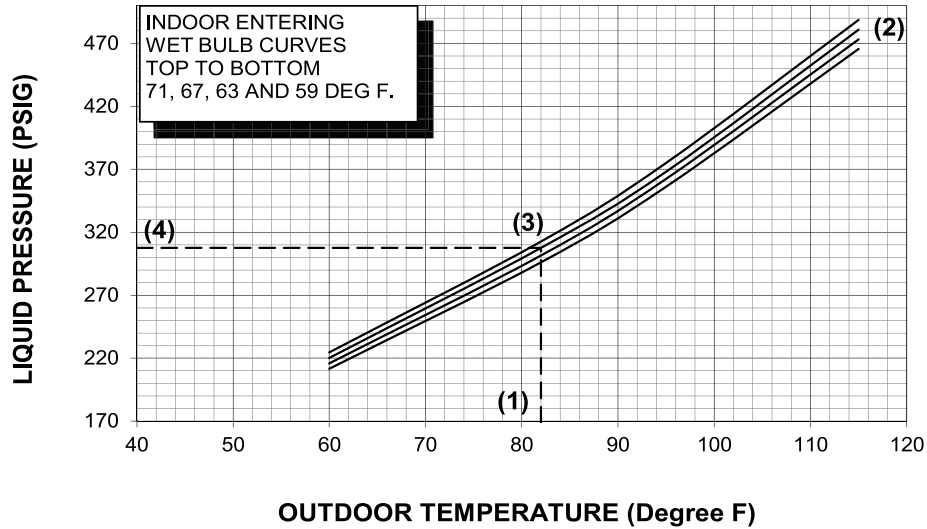

COOLING PERFORMANCE CAN BE CHECKED WHEN THE OUTDOOR TEMP IS ABOVE 55F

* WHEN USING PRESSURE CURVES TO VERIFY TYPICAL PERFORMANCE, ALWAYS RUN THE SYSTEM WITH ONE OF THE TEST MODES FOUND IN THE 950/850 COMFORT CONTROL. CHARGING MODE - COOLING.

TO CHECK COOLING PERFORMANCE, SELECT THE PROPER INDOOR CFM, ALLOW PRESSURES TO STABILIZE. MEASURE INDOOR WET BULB TEMPERATURE, OUTDOOR TEMPERATURE, LIQUID AND SUCTION PRESSURES. ON THE PLOTS, LOCATE OUTDOOR TEMPERATURE (1); LOCATE INDOOR WET BULB (2); FIND INTERSECTION OF OD TEMP. & ID W.B. (3); READ LIQUID (4) OR SUCTION (5) PRESSURE IN LEFT COLUMN.

EXAMPLE: (1) OUTDOOR TEMP 82 F
(2) INDOOR WET BULB 67 F.
(3) AT INTERSECTION
(4) LIQUID PRESSURE @ 1450 CFM IS 308 PSIG
(5) SUCTION PRESSURE @ 1450 CFM IS 142 PSIG

ACTUAL:
LIQUID PRESSURE SHOULD BE +/- 10 PSI OF CHART
SUCTION PRESSURE SHOULD BE +/- 3 PSIG OF CHART

INTERCONNECTING LINES
GAS - 7/8" O.D.
LIQUID - 3/8"

DWG. NO. 4A7V8048A

Pressure Curves

Figure 30. 4A7V8060A
TAM8C0C60V51
Cooling with Electronic Expansion Valve

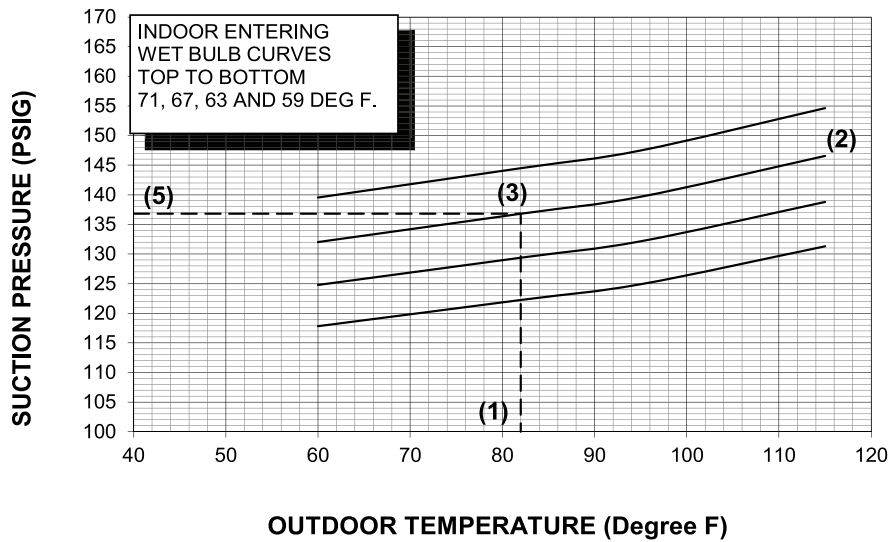
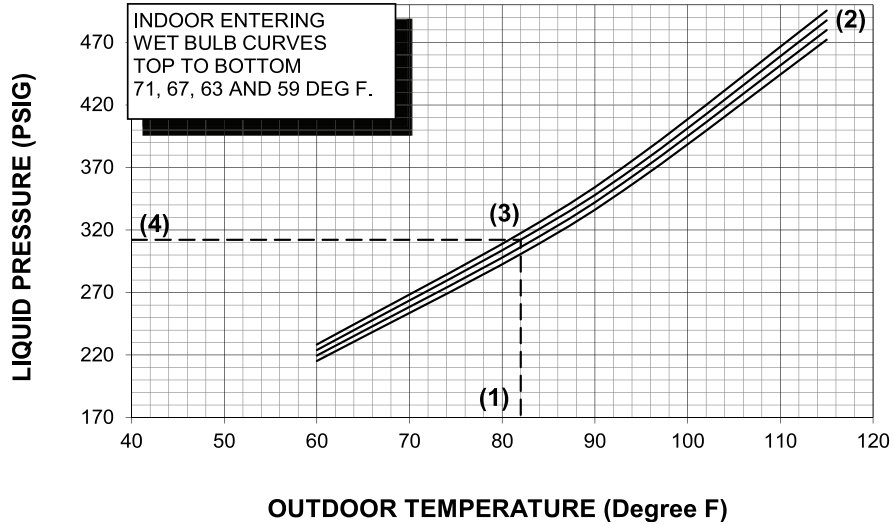

COOLING PERFORMANCE CAN BE CHECKED WHEN THE OUTDOOR TEMP IS ABOVE 55F.
 * WHEN USING PRESSURE CURVES TO VERIFY TYPICAL PERFORMANCE, ALWAYS RUN THE SYSTEM WITH ONE OF THE TEST MODES FOUND IN THE 950/850 COMFORT CONTROL. CHARGING MODE - COOLING.
 TO CHECK COOLING PERFORMANCE, SELECT THE PROPER INDOOR CFM, ALLOW PRESSURES TO STABILIZE. MEASURE INDOOR WET BULB TEMPERATURE, OUTDOOR TEMPERATURE, LIQUID AND SUCTION PRESSURES. ON THE PLOTS, LOCATE OUTDOOR TEMPERATURE (1); LOCATE INDOOR WET BULB (2); FIND INTERSECTION OF OD TEMP. & ID W.B. (3); READ LIQUID (4) OR SUCTION (5) PRESSURE IN LEFT COLUMN.

EXAMPLE: (1) OUTDOOR TEMP. 82 F.
 (2) INDOOR WET BULB 67 F.
 (3) AT INTERSECTION
 (4) LIQUID PRESSURE @ 1450 CFM IS 312 PSIG
 (5) SUCTION PRESSURE @ 1450 CFM IS 137 PSIG

ACTUAL:
 LIQUID PRESSURE SHOULD BE +/- 10 PSI OF CHART
 SUCTION PRESSURE SHOULD BE +/- 3 PSIG OF CHART

INTERCONNECTING LINES
 GAS - 1 - 1/8" O.D.
 LIQUID - 3/8"

DWG. NO. 4A7V8060A

Warranty Claim Process Integrated Variable Speed Control (Drive)

Servicing Dealers must obtain a pre-authorization number from a Field Service Representative (FSR) or a Factory Variable Speed Support Agent to obtain a warranty credit when replacing the Integrated Variable Speed Control (IVSC). This control is also referred to as the drive.

Pre-Authorization Process

If the IVSC (Drive) is suspected to have failed, servicing technicians must follow all troubleshooting guidelines found in the Service Facts or Technical Manual. The local FSR should be contacted for additional diagnostic assistance and/or to obtain a pre-authorization number when a Drive failure has been confirmed. If the local FSR is not available, technicians should call the Factory Variable Speed Support Agent at 1-855-211-8900. This number can also be found inside the control box cover of the Variable Speed Outdoor Unit.

Before a technician calls for pre-authorization:

- Record all current Alert codes found on the 950 comfort control.
- Record all Alert texts found on the Communicating Display Assembly (CDA).
- Run the Drive Diagnostics found in the Technicians Control Menu of the CDA when possible.

When a technician calls for pre-authorization from the job site:

- The FSR or Factory Variable Speed Support Agent will create a CRM ticket to log details of the diagnosis for the Drive warranty claim. The CRM ticket number will be provided to the technician.
- The technician should record and save the CRM ticket number. This will serve as the pre-authorization number.
- To file a warranty claim, the technician should provide the CRM pre-authorization number to the Parts Center agent when receiving the replacement Drive. If truck stock is used, provide the pre-authorization number with the returned Drive.
- The Parts Center representative will enter the CRM pre-authorization number into Falcon for warranty credit and give the technician a return invoice.
- The Falcon claim and CRM ticket will be cross referenced. If invalid, the claim will be reversed.
- All Drives are on Mandatory Return. Use the label provided on the replacement Drive packaging box to record the CRM pre-authorization number and return date.

Notes



American Standard®
HEATING & AIR CONDITIONING

American Standard optimizes the performance of homes and buildings around the world. A business of Ingersoll Rand, the leader in creating and sustaining safe, comfortable and energy efficient environments, American Standard offers a broad portfolio of advanced controls and HVAC systems, comprehensive building services, and parts. For more information, visit www.americanstandardair.com.

American Standard has a policy of continuous product and product data improvements and reserves the right to change design and specifications without notice.

©2016 American Standard Heating & Air Conditioning
4A-V8-SF-1E-EN 11 Jan 2016
Supersedes 4A-V8-SF-1D-EN (November 2015)

