



SPECIFICATIONS

AS50

EXHAUST FAN



50 CFM/3.0 Sones @ 0.10" SP.

- Grill**
 White, polymeric grill secured in place with torsion springs; easily removed if necessary, dimensions - 10" x 9 1/2".
- Blower Wheel**
 One piece polymeric wheel, 4 1/2" diameter, 1" wide, with 10 fins.
- Motor**
 Single coil plug-in, two pole motor, life time lubrication, thermally protected. Rated 120 volts, 60 hz. Rated for continuous use.
- Fan Housing**
 23 gauge galvanized metal housing, dimensions 7 1/4" x 7 1/4" x 3 3/4", double metal thickness mounting tabs.
- Duct Collar**
 Plastic collar for 3" duct connection, comes complete with built in non-metallic back draft damper for quiet operation.
- Ventilating Area**
 For bathrooms up to 50 sq. ft. for other rooms up to 60 sq. ft.
- Unit Mounting**
 Designed to mount in ceilings or walls with at least 4" of clearance. The housing will mount through drywall thickness up to 3/4", with a rough-in opening of 7 1/2" x 7 1/2".
- Single Pack Shipping Info**
 Box Dim: 11" x 10 3/8" x 4 3/4"
 UPC: 0-8316225311-8
 Shipping Weight: 3.6 lbs.

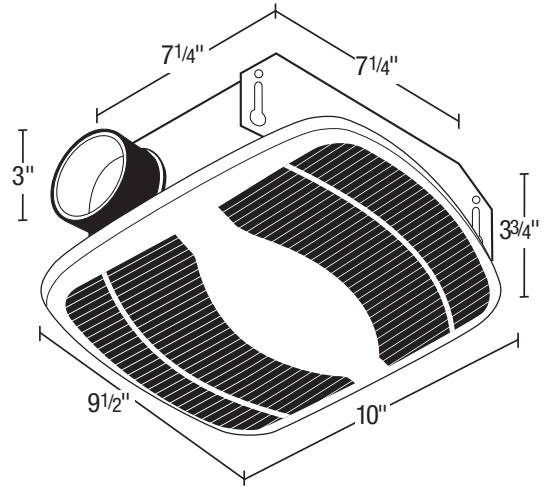

Acceptable for use over tub or shower when installed in a GFCI protected branch circuit.

EXPANDED PERFORMANCE

	Static Pressure (inches of w.g.)							Sones @ .1 SP	Fan Speed RPM	Maximum Fan Watts	Amps
	0	0.05	0.1	0.125	0.15	0.2	0.25				
Air Flow - CFM	55	53	50	49	47	44	39	3.0	2125	48	0.9

PROJECT							ARCHITECT				
LOCATION							ENGINEER				
CONTRACTOR							SUBMITTED BY			DATE	
FAN NUMBER	MODEL NUMBER	CFM	IN W.G.	RPM	WATTS	AMPS	SONES	QTY	OPTIONAL EQUIPMENT & REMARKS		



U.S.: 820 Lincoln Avenue
 West Chester, Pennsylvania 19380-4466
 Tel: (610) 692-7400 • 877-304-3785
 Fax: (610) 696-8048

Canada:
 Brampton, Ontario
 Tel: 905-456-2033
 Fax: (905) 456-1015